

STORMWATER POLLUTION PREVENTION PLAN

for

DONNER PASS ROAD IMPROVEMENTS (CA FLAP NEV 40(1))

RISK LEVEL 3

Legally Responsible Person (LRP):

Federal Highway Administration
Central Federal Lands Highway Division
12300 West Dakota Avenue
Lakewood, CO 80228

Approved Signatory:

Matthew Ambroziak, Project Manager

Prepared for:

Herback General Engineering
2531 Nowlin Road
Minden, Nevada 89423
Phone: (775) 267-6800

Project Address:

Donner Pass Road
Nevada County and Placer County

SWPPP Prepared by:

Zila
10880 Wilshire Blvd, Suite 1101, Los Angeles, CA 90024
Mohammad Arhami, PhD, PE, QSD #C72853
Phone: 323-455-5012

SWPPP Preparation Date

11/15/2021

Estimated Project Dates:

Start of Construction 05/25/2020 Completion of Construction 08/31/2023

Table of Contents

Table of Contents	i
Qualified SWPPP Developer.....	1
Legally Responsible Person.....	1
Amendment Log.....	2
Section 1 SWPPP Requirements	3
1.1 Introduction.....	3
1.2 Permit Registration Documents	3
1.3 SWPPP Availability and Implementation.....	4
1.4 SWPPP Amendments.....	4
1.5 Retention of Records.....	5
1.6 Required Non-Compliance Reporting	6
1.7 Annual Report.....	7
1.8 Changes to Permit Coverage.....	7
1.9 Notice of Termination.....	7
Section 2 Project Information	8
2.1 Project and Site Description.....	8
2.1.1 Site Description.....	8
2.1.2 Existing Conditions.....	8
2.1.3 Existing Drainage.....	8
2.1.5 Project Description.....	9
2.1.6 Developed Condition	10
2.2 Permits and Governing Documents	10
2.3 Stormwater Run-On from Offsite Areas.....	10
2.4 Findings of the Construction Site Sediment and Receiving Water Risk Determination 10	
2.5 Construction Schedule	12
2.6 Potential Construction Activity and Pollutant Sources.....	12
2.7 Identification of Non-Stormwater Discharges	13
2.8 Required Site Map Information	14
Section 3 Best Management Practices	15
3.1 Schedule for BMP Implementation	15

3.2	Erosion and Sediment Control	17
3.2.1	Erosion Control	17
3.2.2	Sediment Controls	19
3.3	Non-Stormwater Controls and Waste and Materials Management	22
3.3.1	Non-Stormwater Controls	22
3.3.2	Materials Management and Waste Management	25
3.4	Post construction Stormwater Management Measures	29
Section 4	BMP Inspection, Maintenance and Rain Event Action Plans	30
4.1	BMP Inspection and Maintenance	30
4.2	Rain Event Action Plans	30
Section 5	Training	32
Section 6	Responsible Parties and Operators	33
6.1	Responsible Parties	33
6.2	Contractor List	34
Section 7	Construction Site Monitoring Program.....	35
7.1	Purpose.....	35
7.2	Applicability of Permit Requirements	35
7.3.	Weather and Rain Event Tracking.....	35
7.3.1	Weather Tracking.....	36
7.3.2	Rain Gauges	36
7.4	Monitoring Locations.....	36
7.5	Safety and Monitoring Exemptions	36
7.6	Visual Monitoring.....	36
7.6.1	Routine Observations and Inspections.....	37
7.6.1.1	Routine BMP Inspections	37
7.6.1.2	Non-Stormwater Discharge Observations	37
7.6.2	Rain-Event Triggered Observations and Inspections	38
7.6.2.1	Visual Observations Prior to a Forecasted Qualifying Rain Event.....	38
7.6.2.2	BMP Inspections During an Extended Storm Event.....	38
7.6.2.3	Visual Observations Following a Qualifying Rain Event.....	38
7.6.3	Visual Monitoring Procedures	39
7.6.4	Visual Monitoring Follow-Up and Reporting.....	39
7.6.5	Visual Monitoring Locations	39

7.7	Water Quality Sampling and Analysis.....	40
7.7.1	Sampling and Analysis Plan for Non-Visible Pollutants in Stormwater Runoff Discharges.....	40
7.7.1.1	Sampling Schedule.....	42
7.7.1.2	Sampling Locations	42
7.7.1.3	Monitoring Preparation.....	44
7.7.1.4	Analytical Constituents.....	45
7.7.1.5	Sample Collection.....	46
7.7.1.6	Sample Analysis.....	46
7.7.1.7	Data Evaluation and Reporting.....	49
7.7.2	Sampling and Analysis Plan for pH and Turbidity in Stormwater Runoff Discharges.....	49
7.7.2.1	Sampling Schedule.....	49
7.7.2.2	Sampling Locations	50
7.7.2.3	Monitoring Preparation.....	51
7.7.2.4	Field Parameters.....	51
7.7.2.5	Sample Collection.....	52
7.7.2.6	Field Measurements	52
7.7.2.7	Data Evaluation and Reporting.....	53
7.7.3	Sampling and Analysis Plan for pH, Turbidity, and SSC in Receiving Water.....	54
7.7.4	Sampling and Analysis Plan for Non-Stormwater Discharges.....	57
7.7.4.1	Sampling Schedule.....	58
7.7.4.2	Sampling Locations	58
7.7.4.3	Monitoring Preparation.....	59
7.7.4.4	Analytical Constituents.....	60
7.7.4.5	Sample Collection.....	61
7.7.4.6	Sample Analysis.....	61
7.7.4.7	Data Evaluation and Reporting.....	61
7.7.5	Sampling and Analysis Plan for Other Pollutants Required by the Regional Water Board	63
7.7.5.1	Sampling Schedule.....	63
7.7.5.2	Sampling Locations	63
7.7.5.3	Monitoring Preparation.....	63

7.7.5.4	Sample Collection.....	64
7.7.5.5	Sample Analysis.....	64
7.7.5.6	Data Evaluation and Reporting.....	66
7.7.6	Training of Sampling Personnel	66
7.7.7	Sample Collection and Handling	66
7.7.7.1	Sample Collection.....	66
7.7.7.2	Sample Handling.....	67
7.7.7.3	Sample Documentation Procedures	68
7.8	Active Treatment System Monitoring	68
7.9	Bioassessment Monitoring.....	68
7.10	Watershed Monitoring Option	69
7.11	Quality Assurance and Quality Control.....	69
7.11.1	Field Logs	69
7.11.2	Clean Sampling Techniques	69
7.11.3	Chain of Custody	70
7.11.4	QA/QC Samples.....	70
7.11.4.1	Field Duplicates.....	70
7.11.4.2	Equipment Blanks	70
7.11.4.3	Field Blanks.....	70
7.11.4.4	Travel Blanks	71
7.11.5	Data Verification.....	71
7.12	Records Retention.....	72
CSMP Attachment 1: Weather Reports.....		73
CSMP Attachment 2: Monitoring Records		74
CSMP Attachment 3: Example Forms.....		75
CSMP Attachment 4: Field Meter Instructions		82
CSMP Attachment 5: Supplemental Information.....		83
Section 8 References.....		84
<i>Appendix A:</i>	<i>Calculations.....</i>	<i>85</i>
<i>Appendix B:</i>	<i>Site Maps</i>	<i>86</i>
<i>Appendix C:</i>	<i>Permit Registration Documents.....</i>	<i>87</i>
<i>Appendix D:</i>	<i>SWPPP Amendment Certifications</i>	<i>89</i>
<i>Appendix E:</i>	<i>Submitted Changes to PRDs</i>	<i>91</i>

<i>Appendix F:</i>	<i>Construction Schedule</i>	93
<i>Appendix G:</i>	<i>Construction Activities, Materials Used, and Associated Pollutants</i>	94
<i>Appendix H:</i>	<i>CASQA Stormwater BMP Handbook Portal: Construction Fact Sheets</i>	97
<i>Appendix I:</i>	<i>BMP Inspection Form</i>	98
<i>Appendix J:</i>	<i>Project Specific Rain Event Action Plan Template</i>	105
	Rain Event Action Plan (REAP)	106
	Date of REAP	106
	WDID Number:	106
	Date Rain Predicted to Occur:	106
	Predicted % chance of rain:	106
<i>Appendix K:</i>	<i>Training Reporting Form</i>	108
<i>Appendix L:</i>	<i>Responsible Parties</i>	110
<i>Appendix M:</i>	<i>Contractors and Subcontractors</i>	115
	<i>SUBCONTRACTORS:</i>	116
<i>Appendix N:</i>	<i>Construction General Permit</i>	117

Qualified SWPPP Developer

Approval and Certification of the Stormwater Pollution Prevention Plan

Project Name: DONNER PASS ROAD IMPROVEMENTS (CA FLAP NEV 40(1))

Project Number/ID _____

“This Stormwater Pollution Prevention Plan and Attachments were prepared under my direction to meet the requirements of the California Construction General Permit (SWRCB Orders No. 2009-009-DWQ as amended by Order 2010-0014-DWQ and Order 2012-0006-DWQ). I certify that I am a Qualified SWPPP Developer in good standing as of the date signed below.”



11/15/2021

QSD Signature

Date

Mohammad Arhami

C72853

QSD Name

QSD Certificate Number

PE, QSD

323-455-5012

Title and Affiliation

Telephone Number

alex@zilaco.com

Email

Legally Responsible Person

Approval and Certification of the Stormwater Pollution Prevention Plan

Project Name: DONNER PASS ROAD IMPROVEMENTS (CA FLAP NEV 40(1))

Project Number/ID _____

"I certify under penalty of law that this document and all Attachments were prepared under my direction or supervision in accordance with a system designed to assure that qualified personnel properly gather and evaluate the information submitted. Based on my inquiry of the person or persons who manage the system or those persons directly responsible for gathering the information, to the best of my knowledge and belief, the information submitted is, true, accurate, and complete. I am aware that there are significant penalties for submitting false information, including the possibility of fine and imprisonment for knowing violations."

Legally Responsible Person [if organization]

Signature of [Authorized Representative of] Legally Responsible Person or Approved Signatory

Date

Name of [Authorized Representative of] Legally Responsible Person or Approved Signatory

Telephone Number

Amendment Log

Project Name:

DONNER PASS ROAD IMPROVEMENTS (CA FLAP NEV 40(1))

Project Number/ID

Amendment No.	Date	Brief Description of Amendment, include section and page number	Prepared and Approved By
			Name: QSD#
			Name: QSD#
			Name: QSD#
			Name: QSD#
			Name: QSD#
			Name: QSD#
			Name: QSD#
			Name: QSD#
			Name: QSD#
			Name: QSD#

Section 1 SWPPP Requirements

1.1 INTRODUCTION

DONNER PASS ROAD IMPROVEMENTS (CA FLAP NEV 40(1)) comprises approximately 56 acres and is located at Donner Pass Road within Tahoe National Forest in Nevada County, California.. The property is owned by Nevada and Placer Counties and is being developed by Herback General Engineering. The projects location is shown on the Site Map in Appendix B.

This Stormwater Pollution Prevention Plan (SWPPP) is designed to comply with California's General Permit for Stormwater Discharges Associated with Construction and Land Disturbance Activities (General Permit) issued by the State Water Resources Control Board (State Water Board). This SWPPP has been prepared following the SWPPP Template provided on the California Stormwater Quality Association Stormwater *Best Management Practice Handbook Portal: Construction* (CASQA, 2012). In accordance with the General Permit, Section XIV, this SWPPP is designed to address the following:

- Pollutants and their sources, including sources of sediment associated with construction, construction site erosion and other activities associated with construction activity are controlled;
- Where not otherwise required to be under a Regional Water Quality Control Board (Regional Water Board) permit, all non-stormwater discharges are identified and either eliminated, controlled, or treated;
- Site BMPs are effective and result in the reduction or elimination of pollutants in stormwater discharges and authorized non-stormwater discharges from construction activity to the Best Available Technology/Best Control Technology (BAT/BCT) standard;
- Identify and provide methods to implement Rain Event Action Plan

1.2 PERMIT REGISTRATION DOCUMENTS

Required Permit Registration Documents (PRDs) shall be submitted to the State Water Board via the Stormwater Multi Application and Report Tracking System (SMARTS) by the Legally Responsible Person (LRP), or authorized personnel (i.e., Approved Signatory) under the direction of the LRP. The project-specific PRDs include:

1. Notice of Intent (NOI);
2. Risk Assessment (Construction Site Sediment and Receiving Water Risk Determination);
3. Site Map;
4. Annual Fee;
5. Signed Certification Statement (LRP Certification is provided electronically with SMARTS PRD submittal); and
6. SWPPP.
7. Air Quality Regulations and Permits

Site Maps can be found in Appendix B. A copy of the submitted PRDs shall also be kept in Appendix C along with the Waste Discharge Identification (WDID) confirmation.

1.3 SWPPP AVAILABILITY AND IMPLEMENTATION

The discharger shall make the SWPPP available at the construction site during working hours (see Section 7.5 of CSMP for working hours) while construction is occurring and shall be made available upon request by a State or Municipal inspector. When the original SWPPP is retained by a crewmember in a construction vehicle and is not currently at the construction site, current copies of the BMPs and map/drawing will be left with the field crew and the original SWPPP shall be made available via a request by radio/telephone. (CGP Section XIV.C)

The SWPPP shall be implemented concurrently with the start of ground disturbing activities.

1.4 SWPPP AMENDMENTS

The SWPPP should be revised when:

- If there is a General Permit violation.
- When there is a reduction or increase in total disturbed acreage (General Permit Section II Part C).
- BMPs do not meet the objectives of reducing or eliminating pollutants in stormwater discharges.

Additionally, the SWPPP shall be amended when:

- There is a change in construction or operations which may affect the discharge of pollutants to surface waters, groundwater(s), or a municipal separate storm sewer system (MS4);
- When there is a change in the project duration that changes the project's risk level; or
- When deemed necessary by the QSD. The QSD has determined that the changes listed in Table 1.1 can be field determined by the QSP. All other changes shall be made by the QSD as formal amendments to the SWPPP.

The following items shall be included in each amendment:

- Who requested the amendment;
- The location of proposed change;
- The reason for change;
- The original BMP proposed, if any; and
- The new BMP proposed.

Amendment shall be logged at the front of the SWPPP and certification kept in Appendix D. The SWPPP text shall be revised replaced, and/or hand annotated as necessary to properly convey the amendment. SWPPP amendments must be made by a QSD. The following changes have been designated by the QSD as "to be field determined" and constitute minor changes that the QSP may implement based on field conditions.

Table 1.1 List of Changes to be Field Determined

Candidate changes for field location or determination by QSP ⁽¹⁾	Check changes that can be field located or field determined by QSP
Increase quantity of an Erosion or Sediment Control Measure	<i>Yes</i>
Relocate/Add stockpiles or stored materials	<i>Yes</i>
Relocate or add toilets	<i>Yes</i>
Relocate vehicle storage and/or fueling locations	<i>Yes</i>
Relocate areas for waste storage	<i>Yes</i>
Relocate water storage and/or water transfer location	<i>Yes</i>
Changes to access points (entrance/exits)	<i>Yes</i>
Change type of Erosion or Sediment Control Measure	<i>No</i>
Changes to location of erosion or sediment control	<i>No</i>
Minor changes to schedule or phases	<i>Yes</i>
Changes in construction materials	<i>No</i>
<i>(1) Any field changes not identified for field location or field determination by QSP must be approved by QSD</i>	

1.5 RETENTION OF RECORDS

Paper or electronic records of documents required by this SWPPP shall be retained for a minimum of three years from the date generated or date submitted, whichever is later, for the following items:

- Approved SWPPP Documentation and Amendments
- Site Inspection Reports
- Compliance Certification
- Discharge Reports

These records shall be available at the Site until construction is complete. Records assisting in the determination of compliance with the General Permit shall be made available within a reasonable time, to the Regional Water Board, State Water Board or U.S. Environmental Protection Agency (EPA) upon request. Requests by the Regional Water Board for retention of records for a period longer than three years shall be adhered to.

1.6 REQUIRED NON-COMPLIANCE REPORTING

If a General Permit discharge violation occurs the QSP shall immediately notify the LRP. The LRP shall include information on the violation with the Annual Report. Corrective measures will be implemented immediately following identification of the discharge or written notice of non-compliance from the Regional Water Board. Discharges and corrective actions must be documented and include the following items:

- The date, time, location, nature of operation and type of unauthorized discharge.
- The cause or nature of the notice or order.
- The control measures (BMPs) deployed before the discharge event, or prior to receiving notice or order.
- The date of deployment and type of control measures (BMPs) deployed after the discharge event, or after receiving the notice or order, including additional measures installed or planned to reduce or prevent re-occurrence.

Reporting requirements for Numeric Action Levels (NALs) exceedances are discussed in Section 7.7.2.7.

1.7 ANNUAL REPORT

The General Permit requires that permittees prepare, certify, and electronically submit an Annual Report no later than September 1st of each year. Reporting requirements are identified in Section XVI of the General Permit. Annual reports will be filed in SMARTS and in accordance with information required by the on-line forms.

1.8 CHANGES TO PERMIT COVERAGE

The General Permit allows for the reduction or increase of the total acreage covered under the General Permit when: a portion of the project is complete and/or conditions for termination of coverage have been met; when ownership of a portion of the project is purchased by a different entity; or when new acreage is added to the project.

Modified PRDs shall be filed electronically within 30 days of a reduction or increase in total disturbed area if a change in permit covered acreage is to be sought. The SWPPP shall be modified appropriately, shall be logged at the front of the SWPPP and certification of SWPPP amendments are to be kept in Appendix D. Updated PRDs submitted electronically via SMARTS can be found in Appendix E.

1.9 NOTICE OF TERMINATION

A Notice of Termination (NOT) must be submitted electronically by the LRP via SMARTS to terminate coverage under the General Permit. The NOT must include a final Site Map and representative photographs of the project site that demonstrate final stabilization has been achieved. The NOT shall be submitted within 90 days of completion of construction. The Regional Water Board will consider a construction site complete when the conditions of the General Permit, Section II.D have been met.

Section 2 Project Information

2.1 PROJECT AND SITE DESCRIPTION

2.1.1 Site Description

DONNER PASS ROAD IMPROVEMENTS (CA FLAP NEV 40(1)) project site comprises approximately 56 acres. This improvements were divided into five segments. Segment N1 begins at Exit 174 off I-80 at the beginning of the project (STA 104+50) and extends 0.1 mile to STA 111+10 in Nevada County. Segment N2 begins at the end of N1 and extends 2.3 miles to STA 231+20, also in Nevada County. Segment P3 extends from STA 231+20 to 280+90 (1 mile) in Placer County. Segment N4 extends from the Placer County line to Donner Summit, specifically STA 280+90 to 304+50 (0.4 mile). Segment N5 extends from Donner Summit to Truckee City limit, specifically STA 304+50 to 442+50 (2.6 miles). The project location is identified on the Site Map in Appendix B.

2.1.2 Existing Conditions

As of the initial date of this SWPPP, the project site is developed and includes both impervious and pervious areas. No known historic sources of contamination have been reported along the road.

Donner Pass Road is a two-lane paved local road that connects I-80 to the towns of Soda Springs, Norden, and Truckee. It has narrow shoulders and limited roadside ditches, especially through the towns. Steep slopes outside the towns near Donner Pass also limit the road width.

2.1.3 Existing Drainage

Donner Pass Road crosses a major pass over the Sierra Nevada mountain range and continues west along the base of Boreal Ridge. The road runs parallel to the north shore of Lake Van Norden. Elevations along the road range from approximately 6,100 to 7,200 feet above mean sea level (amsl), with varied topography consisting of steep, exposed barren granite rock faces dotted with vegetation, flat valleys, and wet meadows at the edge of dry and steep ridges. Stormwater follows the road toward South Yuba River or Upper Castle Creek into Lake Van Norden on the west side of the pass and Donner Creek into Donner Lake on the east side. Several intermittent and ephemeral tributaries cross the road and convey flow into those named drainages.

The South Fork Yuba River, from its headwaters to Lake Spaulding is listed as a Section 303(d) Impaired Water Body for pH and copper. Upper Castle Creek is also listed for pH. Donner Lake is listed for arsenic, chlordane, and polychlorinated biphenyls (PCBs). TMDLs have not yet been completed.

2.1.4 Geology and Groundwater

The project area is in the Sierra Nevada physiographic province near the western border of the Basin and Range province. This physiographic province was influenced by glacier scouring, alluvial fan deposits, and glacial outwash, and most of these geological features are evident within the project area. Numerous unique geologic features are exposed in the project area,

including large granite rock walls and outcroppings. Soils have a slow infiltration rate due to high clay content.

2.1.5 Project Description

The proposed action consists of rehabilitating 6.54 miles of pavement and improving drainage infrastructure along Donner Pass Road. Project improvements also include guardrail upgrades, shoulder widening, and paving of selected existing pullouts to improve parking for trailheads, rock climbing, and historical sightseeing access. West of Donner Pass, both sides of the road will be widened to provide 4-foot wide paved shoulders to accommodate designated bicycle lanes. East of Donner Pass, only the westbound (uphill) side of the road will be widened to provide a 4-foot wide paved shoulder due to tightly constrained terrain. In some locations, minor rock cuts will be needed for the 4-foot wide paved shoulder. Minor, limited rock cuts and excavation will involve scaling, controlled trim blasting, and the use of hoe ram techniques. Excavations will remove up to 1,000 cubic yards of hard granite rock. They will occur at up to 16 locations along relatively short (i.e. 10 to 20 feet in length) sections and total at most 1,835 lineal feet (or 0.35 miles) of the uphill (westbound) side of the road.

Several existing pullouts and parking areas along Donner Pass Road will be paved or the gravel surface will be reshaped:

- the chain-up area near Bunny Hill Drive is paved so minor work would occur at this
- location (near Project Milepost 1.3);
- pave the gravel pullout at the “airway station;”
- repave and stripe the parking area at Donner Summit/Rainbow Bridge; and
- reshape the gravel pullout at the China Wall rock climbing area.

Local residential and business access in Soda Springs will involve minor modifications associated with the regrading of ingress/egress driveways. Drainage improvements will consist of cleaning select culverts, as well as extending, replacing, and installing new inlets and culverts to accommodate the widened shoulders. Several new culverts are proposed on the east side of the pass to help mitigate the erosion problems present from water sheet-flowing over the road and down the steep embankment. Utility impacts are expected to be limited to adjusting existing manholes and valve boxes to facilitate construction and completing minor adjustments to the road profile.

Preliminary design for the proposed road improvements is scheduled to be completed by the end of Spring 2019 with construction expected to be begin in Summer 2019 and lasting for two construction seasons. Construction timing is subject to change based on the availability of funding and receipt of project permits and approvals. During construction, one lane of the road will be closed on the west side of the pass resulting in minor delays. On the east side, a full closure will be allowed from Monday at 7am until Friday at 5pm, at which time the road would be reopened, with short single-lane closures. A short closure is also expected just west of the overlook during retaining wall construction. Flaggers, or temporary traffic signals, on each end of the closure will manage traffic flow. Short-term closures lasting a few hours may also be required due to blasting for the rock-cuts.

2.1.6 Developed Condition

Post construction surface drainage will be similar to existing conditions, with runoff following the roadway toward the nearest surface water. Improved culverts will help convey runoff under the road, and ditches along the road will direct the flow away from the roadway.

The western portion of the project area (33.7 acres) is in the Rattlesnake Creek-South Yuba River watershed (HUC 180201250602). The eastern portion of the project area (22.1 acres) is in the Donner Creek watershed (HUC 160501020201). The estimated area of disturbance in each watershed is 22.9 acres in Rattlesnake Creek-South Yuba and 15.1 acres in Donner Creek. Estimates of pervious and impervious surface areas in the construction limits for each watershed are below.

Table 2.1 Construction Site Estimates

Project area	56	acres
Area to be disturbed	38	acres
Area of existing impervious surfaces	18.6	acres
Area of proposed impervious surfaces	22	acres
Percent impervious before construction	49	%
Percent impervious after construction	58	%

2.2 PERMITS AND GOVERNING DOCUMENTS

In addition to the General Permit, the following documents have been taken into account while preparing this SWPPP

- Regional Water Board requirements
- Contract Documents
- Clean Water Act Section 401 Water Quality Certifications and 404 Permits

2.3 STORMWATER RUN-ON FROM OFFSITE AREAS

The General Permit requires that temporary BMPs be implemented to direct offsite run-on away from disturbed areas through the use of runoff controls.

There are offsite run-on from upstream to this construction site. Run-on to the site is generated on the north of the project site. Gravel Bag Berms (SE-6) and Check Dams (SE-4) will be placed on the northern section of the project site to direct offsite run-on away from entering the site.

2.4 FINDINGS OF THE CONSTRUCTION SITE SEDIMENT AND RECEIVING WATER RISK DETERMINATION

A construction site risk assessment has been performed for the project and the resultant risk level is Risk Level 3.

The risk level was determined through the use of the State Water Resources Control Board's Interactive Caltrans and EPA Tool. The risk level is based on project duration, location, proximity to impaired receiving waters and soil conditions. A copy of the Risk Level determination submitted on SMARTS with the PRDs is included in Appendix C.

Table 2.2 and Table 2.3 summarize the sediment and receiving water risk factors and document the sources of information used to derive the factors.

Table 2.2 Summary of Sediment Risk

RUSLE Factor	Value	Method for establishing value
R	402.69	EPA Rainfall Erosivity Calculator
K	0.2	Caltrans Map
LS	1.89	Site specific calculations
Total Predicted Sediment Loss (tons/acre)		152.217
Overall Sediment Risk Low Sediment Risk < 15 tons/ acre Medium Sediment Risk >= 15 and < 75 tons/acre High Sediment Risk >= 75 tons/acre		<input type="checkbox"/> Low <input type="checkbox"/> Medium <input checked="" type="checkbox"/> High

Runoff from the project site discharges into South Yuba River or Upper Castle Creek and Donner Creek.

Table 2.3 Summary of Receiving Water Risk

Receiving Water Name	303(d) Listed for Sediment Related Pollutant ⁽¹⁾	TMDL for Sediment Related Pollutant ⁽¹⁾	Beneficial Uses of COLD, SPAWN, and MIGRATORY ⁽¹⁾
Llagas Creek	<input type="checkbox"/> Yes <input checked="" type="checkbox"/> No	<input type="checkbox"/> Yes <input checked="" type="checkbox"/> No	<input checked="" type="checkbox"/> Yes <input type="checkbox"/> No
Overall Receiving Water Risk			<input type="checkbox"/> Low <input checked="" type="checkbox"/> High
(1) If yes is selected for any option the Receiving Water Risk is High			

Risk Level 3 sites are subject to both the narrative and numeric effluent standards. The narrative effluent limitations require stormwater discharges associated with construction activity to minimize or prevent pollutants in stormwater and authorized non-stormwater through the use of controls, structures, and best management practices. Discharges from Risk Level 3 sites are subject to NALs. NALs are shown in Table 2-4. This SWPPP has been prepared to address Risk Level 3 requirements (General Permit Attachment E).

Table 2.4 Numeric Action Levels

Parameter	Unit	Numeric Action Level Daily Average	Receiving Water Monitoring Trigger Daily Average
pH	pH units	Lower NAL = 6.5 Upper NAL = 8.5	Lower Trigger = 6.0 Upper Trigger = 9.0
Turbidity	NTU	250 NTU	500 NTU

2.5 CONSTRUCTION SCHEDULE

The site sediment risk was determined based on construction taking place between 05/25/2020 and 08/31/2023. Modification or extension of the schedule (start and end dates) may affect risk determination and permit requirements. The LRP shall contact the QSD if the schedule changes during construction to address potential impact to the SWPPP. The estimated schedule for planned work can be found in Appendix F.

2.6 POTENTIAL CONSTRUCTION ACTIVITY AND POLLUTANT SOURCES

Appendix G includes a list of construction activities and associated materials that are anticipated to be used onsite. Following is a list of some of these construction activities and associated materials that are anticipated to be used onsite. These activities and associated materials will or could potentially contribute pollutants, other than sediment, to stormwater runoff.

- Grading
- Demolition
- Excavating
- Paving and Grinding Operation
- Painting products for striping and marking
- Chemical waste from stationary toilets
- Vehicle and equipment fueling and batteries
- Concrete washout
- General site litter

The anticipated activities and associated pollutants were used in Section 3 to select the Best Management Practices for the project. Location of anticipated pollutants and associated BMPs are shown on the Site Map in Appendix B.

For sampling requirements for non-visible pollutants associated with construction activity please refer to Section 7.7.1. For a full and complete list of onsite pollutants, refer to the Material Safety Data Sheets (MSDS), which are retained onsite at the construction trailer.

2.7 IDENTIFICATION OF NON-STORMWATER DISCHARGES

Non-stormwater discharges consist of discharges which do not originate from precipitation events. The General Permit provides allowances for specified non-stormwater discharges that do not cause erosion or carry other pollutants.

Non-stormwater discharges into storm drainage systems or waterways, which are not authorized under the General Permit and listed in the SWPPP, or authorized under a separate NPDES permit, are prohibited.

Non-stormwater discharges that are authorized from this project site include the following:

- None

These authorized non-stormwater discharges will be managed with the stormwater and non-stormwater BMPs described in Section 3 of this SWPPP and will be minimized by the QSP.

Activities at this site that may result in unauthorized non-stormwater discharges include:

- Concrete washout
- Vehicle and equipment fueling and maintenance
- Vehicle and equipment cleaning, fueling and maintenance operations;
- Vehicle and equipment wash water, including concrete washout water;
- Slurries from concrete cutting and coring operations, PCC grinding or AC grinding operations;
- Slurries from concrete or mortar mixing operations;
- Slurries from drilling or boring operations;
- Blast residue from high-pressure washing of structures or surfaces;
- Wash water from cleaning painting equipment;
- Runoff from dust control applications of water or dust palliatives;
- Sanitary and septic wastes;
- Chemical leaks and/or spills of any kind including but not limited to petroleum, paints, cure compounds, etc.
- Use of water for dust control

Steps will be taken, including the implementation of appropriate BMPs, to ensure that unauthorized discharges are eliminated, controlled, disposed, or treated on-site.

Discharges of construction materials and wastes, such as fuel or paint, resulting from dumping, spills, or direct contact with rainwater or stormwater runoff, are also prohibited.

The following discharge(s) have been authorized by (a) regional NPDES permit(s):

- None

2.8 REQUIRED SITE MAP INFORMATION

The construction project's Site Map(s) showing the project location, surface water map, general topography/geographic features, construction site perimeter and other requirements identified in Attachment B of the General Permit is located in Appendix B.

Section 3 Best Management Practices

3.1 SCHEDULE FOR BMP IMPLEMENTATION

Table 3.1 BMP Implementation Schedule

	BMP	Implementation	Duration
Erosion Control	EC-1, Scheduling	Prior to Construction	Entirety of Project
	EC-2, Preservation of Existing Vegetation	Start of Construction	Entirety of Project
	EC-3, Hydraulic Mulch	Beginning of Soil disturbing activities	Until Final Stabilization
	EC-4, Hydroseed	Beginning of Soil disturbing activities	Until Final Stabilization
	EC-7, Geotextiles and Mats	Beginning of Soil disturbing activities & Stockpiling Materials	Until Final Stabilization
	EC-9, Earth Dike and Drainage Swales	Beginning of Soil disturbing activities	Until Final Stabilization
	EC-10, Velocity Dissipation Devices	Beginning of Soil disturbing activities	Until Final Stabilization
Sediment Control	SE-1: Silt Fence	Beginning of Soil disturbing activities	Entirety of Project
	SE-5: Fiber Rolls	Beginning of Soil disturbing activities	Entirety of Project
	SE-6: Gravel Bag Berm	Beginning of Soil disturbing activities	Entirety of Project
	SE-7: Street Sweeping	Beginning of Soil disturbing activities	Entirety of Project
	SE-10: Inlet Protection	Prior to Construction	Entirety of Project
Tracking Control	SE-7: Street Sweeping	Beginning of Soil disturbing activities	Entirety of Project
	TC-1: Stabilized Construction Entrance and Exit	Prior to Construction	Entirety of Project
Wind Erosion	WE-1: Wind Erosion	Beginning of Soil disturbing activities	Until Final Stabilization

Table 3.1 BMP Implementation Schedule

	BMP	Implementation	Duration
Non – Stormwater	NS-1: Water Conservation Practices	Starting at beginning of project	Entirety of Project Until conclusion
	NS-3: Paving & Grinding Operation	During the operation	Entirety of Project
	NS-6: Illicit Connection, Illegal Discharge	Starting at beginning of project	Entirety of Project
	NS-7: Potable Water/Irrigation	Starting at beginning of project	Entirety of Project
	NS-8: Vehicle and Equipment Cleaning	Starting at beginning of mobilization	Entirety of Project
	NS-9: Vehicle and Equipment Fueling	Starting at beginning of project	Entirety of Project
	NS-10: Vehicle and Equipment Maintenance	Starting at beginning of project	Entirety of Project
	NS-12: Concrete Curing	During the concrete work	Entirety of Project
	NS-13: Concrete Finishing	During the concrete work	Entirety of Project
Materials Management	WM-1: Material Delivery & Storage	Starting at beginning of project	Entirety of Project
	WM-2: Material Use	Starting at beginning of project	Entirety of Project
	WM-3: Stockpile Management	Starting at beginning of project	Entirety of Project
	WM-4: Spill Prevention	Starting at beginning of project	Entirety of Project
	WM-5: Solid Waste Management	Starting at beginning of project	Entirety of Project
	WM-6: Hazardous Waste Management	Starting at beginning of project	Entirety of Project
	WM-8: Concrete Waste Mangement	Starting at beginning of project	Entirety of Project
	WM-9: Sanitary & Septic Waste Management	Starting at beginning of project	Entirety of Project
	WM-10: Liquid Waste Management	Starting at beginning of project	Entirety of Project

3.2 EROSION AND SEDIMENT CONTROL

Erosion and sediment controls are required by the General Permit to provide effective reduction or elimination of sediment related pollutants in stormwater discharges and authorized non-stormwater discharges from the Site. Applicable BMPs are identified in this section for erosion control, sediment control, tracking control, and wind erosion control.

3.2.1 Erosion Control

Erosion control, also referred to as soil stabilization, consists of source control measures that are designed to prevent soil particles from detaching and becoming transported in stormwater runoff. Erosion control BMPs protect the soil surface by covering and/or binding soil particles.

This construction project will implement the following practices to provide effective temporary and final erosion control during construction:

1. Preserve existing vegetation where required and when feasible.
2. The area of soil disturbing operations shall be controlled such that the Contractor is able to implement erosion control BMPs quickly and effectively.
3. Stabilize non-active areas within 14 days of cessation of construction activities or sooner if stipulated by local requirements.
4. Control erosion in concentrated flow paths by applying erosion control blankets, check dams, erosion control seeding or alternate methods.
5. Prior to the completion of construction, apply permanent erosion control to remaining disturbed soil areas.

Sufficient erosion control materials shall be maintained onsite to allow implementation in conformance with this SWPPP.

The following temporary erosion control BMP selection table indicates the BMPs that shall be implemented to control erosion on the construction site. Fact Sheets for temporary erosion control BMPs are provided in Appendix H.

Table 3.2 Temporary Erosion Control BMPs

CASQA Fact Sheet	BMP Name	Meets a Minimum Requirement ⁽¹⁾	BMP Used		If not used, state reason
			YES	NO	
EC-1	Scheduling	✓	Y		
EC-2	Preservation of Existing Vegetation	✓	Y		
EC-3	Hydraulic Mulch		Y		
EC-4	Hydroseed		Y		
EC-5	Soil Binders	✓ ⁽²⁾		N	Not anticipated for this project
EC-6	Straw Mulch			N	Not anticipated for this project
EC-7	Geotextiles and Mats	✓ ⁽²⁾	Y		
EC-8	Wood Mulching	✓ ⁽²⁾		N	Not anticipated for this project
EC-9	Earth Dike and Drainage Swales	✓ ⁽³⁾	Y		
EC-10	Velocity Dissipation Devices		Y		
EC-11	Slope Drains			N	Not anticipated for this project
EC-12	Stream Bank Stabilization			N	Not anticipated for this project
EC-14	Compost Blankets	✓ ⁽²⁾		N	Not anticipated for this project
EC-15	Soil Preparation-Roughening			N	Not anticipated for this project
EC-16	Non-Vegetated Stabilization	✓ ⁽²⁾		N	Not anticipated for this project
WE-1	Wind Erosion Control	✓	Y		
Alternate BMPs Used:					If used, state reason:
<p>⁽¹⁾ Applicability to a specific project shall be determined by the QSD.</p> <p>⁽²⁾ The QSD shall ensure implementation of one of the minimum measures listed or a combination thereof to achieve and maintain the Risk Level requirements.</p> <p>⁽³⁾ Run-on from offsite shall be directed away from all disturbed areas, diversion of offsite flows may require design/analysis by a licensed civil engineer and/or additional environmental permitting</p>					

These temporary erosion control BMPs shall be implemented in conformance with the following guidelines and as outlined in the BMP Factsheets provided in Appendix H. If there is a conflict between documents, the Site Map will prevail over narrative in the body of the SWPPP or guidance in the BMP Fact Sheets. Site specific details in the Site Map prevail over standard details included in the Site Map. The narrative in the body of the SWPPP prevails over guidance in the BMP Fact Sheets.

Scheduling (EC-1)

Contractor shall develop a plan that includes sequencing of construction activities and the implementation of BMPs such as erosion control and sediment control to reduce the amount and duration of soil exposed to erosion by wind, rain, runoff, and vehicle tracking, and to perform the construction activities and control practices in accordance with the planned schedule.

Preservation of Existing Vegetation (EC-2)

Carefully planned preservation of existing vegetation minimizes the potential of removing or damaging existing trees, vines, shrubs, and grasses that protect soil from erosion thereby reducing the risk of erosion.

Hydraulic Mulch (EC-3), Hydroseed (EC-4), Geotextiles and Mats (EC-7)

Use of Geotextiles and Mats (EC-7) is limited to covering stockpiles or very small graded areas for short period of time.

Also temporary erosion controls such as Hydraulic Mulch (EC-3) and Hydroseed (EC-4) or other suitable stabilization measures to protect exposed areas during construction activities from beginning of soil disturbing activities until final stabilization

Wind Erosion Control (WE-1)

Wind erosion or dust control consists of applying water or other chemical dust suppressants as necessary to prevent or alleviate dust nuisance generated by construction activities. Covering small stockpiles or areas is an alternative to applying water or other dust palliatives.

Earth Dike and Drainage Swales (EC-9), Velocity Dissipation Devices (EC-10)

Contractor shall divert water away from construction activities where applicable using appropriate measures such as earth dike and drainage swales (EC-9) and Velocity Dissipation Devices (EC-10).

3.2.2 Sediment Controls

Sediment controls are temporary or permanent structural measures that are intended to complement the selected erosion control measures and reduce sediment discharges from active construction areas. Sediment controls are designed to intercept and settle out soil particles that have been detached and transported by the force of water.

The following sediment control BMP selection table indicates the BMPs that shall be implemented to control sediment on the construction site. Fact Sheets for temporary sediment control BMPs are provided in Appendix H.

Table 3.3 Temporary Sediment Control BMPs

CASQA Fact Sheet	BMP Name	Meets a Minimum Requirement ⁽¹⁾	BMP used		If not used, state reason
			YES	NO	
SE-1	Silt Fence			N	Not anticipated for this project
SE-2	Sediment Basin			N	Not anticipated for this project
SE-3	Sediment Trap			N	Not anticipated for this project
SE-4	Check Dams			N	Not anticipated for this project
SE-5	Fiber Rolls	✓ ⁽²⁾⁽³⁾	Y		
SE-6	Gravel Bag Berm			N	Not anticipated for this project
SE-7	Street Sweeping	✓	Y		
SE-8	Sandbag Barrier			N	Not anticipated for this project
SE-9	Straw Bale Barrier			N	Not anticipated for this project
SE-10	Storm Drain Inlet Protection	✓ RL2&3	Y		
SE-11	ATS			N	Not anticipated for this project
SE-12	Manufactured Linear Sediment Controls			N	Not anticipated for this project
SE-13	Compost Sock and Berm	✓ ⁽³⁾		N	Not anticipated for this project
SE-14	Biofilter Bags	✓ ⁽³⁾		N	Not anticipated for this project
TC-1	Stabilized Construction Entrance and Exit	✓	Y		
TC-2	Stabilized Construction Roadway			N	Not anticipated for this project
TC-3	Entrance Outlet Tire Wash			N	Not anticipated for this project
Alternate BMPs Used:					If used, state reason:
<p>⁽¹⁾ Applicability to a specific project shall be determined by the QSD</p> <p>⁽²⁾ The QSD shall ensure implementation of one of the minimum measures listed or a combination thereof to achieve and maintain the Risk Level requirements</p> <p>⁽³⁾ Risk Level 2 & 3 shall provide linear sediment control along toe of slope, face of slope, and at the grade breaks of exposed slope</p>					

These temporary sediment control BMPs shall be implemented in conformance with the following guidelines and in accordance with the BMP Fact Sheets provided in Appendix H. If there is a conflict between documents, the Site Map will prevail over narrative in the body of the SWPPP or guidance in the BMP Fact Sheets. Site specific details in the Site Map prevail over standard details included in the Site Map. The narrative in the body of the SWPPP prevails over guidance in the BMP Fact Sheets.

Silt Fence (SE-1), Fiber Rolls (SE-5), Gravel Bag Berm (SE-6)

The Contractor may use combination of the sediment control and linear barrier BMPs at exposed soil areas. BMPs will be applied for perimeter protection throughout the construction site. Silt Fence, Fiber rolls may be used as linear sediment control at disturbed soil areas and along the perimeter of job site to prevent silt from discharging off the construction area. Gravel Bag Berm may be used to direct the run-on away from the project site.

Also contractor shall install linear sediment controls (e.g. Fiber Rolls (SE-5)) along the toe of the slope, face of the slope, and at the grade breaks of exposed slopes to comply with sheet flow lengths as follows:

Slope 0-25% Sheet Flow Length not to exceed 20 ft

Slope 25-50% Sheet Flow Length not to exceed 15 ft

Slope > 50% Sheet Flow Length not to exceed 10 ft

Street Sweeping (SE-7)

Street sweeping and vacuuming includes use of self-propelled and walk-behind equipment to remove sediment from streets and roadways, and to clean paved surfaces in preparation for final paving. Sweeping and vacuuming prevents sediment from the project site from entering storm drains or receiving waters. The Contractor shall inspect all immediate access roads daily. The Contractor shall remove any sediment or other construction activity related materials that are deposited on the roads by vacuuming or sweeping on a daily basis (when necessary) and prior to any rain event.

Storm Drain Inlet Protection (SE-10)

Storm drain inlet protection consists of a sediment filter or an impounding area in, around or upstream of a storm drain, drop inlet, or curb inlet. Storm drain inlet protection measures temporarily pond runoff before it enters the storm drain, allowing sediment to settle. Some filter configurations also remove sediment by filtering, but usually the ponding action results in the greatest sediment reduction. Contractor will locate the storm drain inlets on the project perimeter and install appropriate type of protection (gravel bag barrier, geotextile inserts) at discharge points.

Stabilized Construction Entrance and Exit (TC-1)

A stabilized construction access is defined by a point of entrance/exit to the construction site and contractor's staging area that is stabilized to reduce the tracking of mud and dirt onto public roads by construction vehicles.

3.3 NON-STORMWATER CONTROLS AND WASTE AND MATERIALS MANAGEMENT

3.3.1 Non-Stormwater Controls

Non-stormwater discharges into storm drainage systems or waterways, which are not authorized under the General Permit, are prohibited. Non-stormwater discharges for which a separate NPDES permit is required by the local Regional Water Board are prohibited unless coverage under the separate NPDES permit has been obtained for the discharge. The selection of non-stormwater BMPs is based on the list of construction activities with a potential for non-stormwater discharges identified in Section 2.7 of this SWPPP.

The following non-stormwater control BMP selection table indicates the BMPs that shall be implemented to control sediment on the construction site. Fact Sheets for temporary non-stormwater control BMPs are provided in Appendix H.

Table 3.4 Temporary Non-Stormwater BMPs

CASQA Fact Sheet	BMP Name	Meets a Minimum Requirement ⁽¹⁾	BMP used		If not used, state reason
			YES	NO	
NS-1	Water Conservation Practices	✓	Y		
NS-2	Dewatering Operation			N	Not anticipated for this project
NS-3	Paving and Grinding Operation	✓	Y		
NS-4	Temporary Stream Crossing			N	Not anticipated for this project
NS-5	Clear Water Diversion			N	Not anticipated for this project
NS-6	Illicit Connection/Discharge	✓	Y		
NS-7	Potable Water/Irrigation		Y		
NS-8	Vehicle and Equipment Cleaning	✓	Y		
NS-9	Vehicle and Equipment Fueling	✓	Y		
NS-10	Vehicle and Equipment Maintenance	✓	Y		
NS-11	Pile Driving Operation			N	Not anticipated for this project
NS-12	Concrete Curing		Y		
NS-13	Concrete Finishing		Y		
NS-14	Material and Equipment Use Over Water			N	Not anticipated for this project
NS-15	Demolition Removal Adjacent to Water		Y		
NS-16	Temporary Batch Plants			N	Not anticipated for this project
Alternate BMPs Used:			If used, state reason:		
⁽¹⁾ Applicability to a specific project shall be determined by the QSD					

Non-stormwater BMPs shall be implemented in conformance with the following guidelines and in accordance with the BMP Fact Sheets provided in Appendix H. If there is a conflict between documents, the Site Map will prevail over narrative in the body of the SWPPP or guidance in the BMP Fact Sheets. Site specific details in the Site Map prevail over standard details included in the Site Map. The narrative in the body of the SWPPP prevails over guidance in the BMP Fact Sheets.

Water Conservation Practices (NS-1)

Water conservation practices are activities that use water during the construction of a project in a manner that avoids causing erosion and the transport of pollutants offsite. These practices will be used to reduce or eliminate non-stormwater discharges where water is used. Vehicles and equipment will not be washed on site. Water will not be used to clean construction areas.

Paving and Grinding Operation (NS-3)

Prevent or reduce the discharge of pollutants from paving operations, using measures to prevent run-on and run-off pollution. These procedures are implemented where paving, surfacing, resurfacing, or sawcutting, may pollute stormwater runoff or discharge to the storm drain system or watercourses.

Illicit Connection/Discharge (NS-6)

Procedures and practices designed shall be conducted to recognize illicit connections or illegally dumped or discharged materials on a construction site and report incidents. Illicit connection/discharge and reporting is applicable anytime an illicit connection or discharge is discovered or illegally dumped material is found on the construction site.

The site will be inspected before the project commences and regularly during the project for illicit connections or illegal dumping or discharge. If any are found, they will be reported to the Project Manager and Construction Manager at the time of discovery.

Potable Water/Irrigation (NS-7)

Potable Water/Irrigation consists of practices and procedures to manage the discharge of potential pollutants generated during discharges from irrigation water lines, landscape irrigation, lawn or garden watering, planned and unplanned discharges from potable water sources, water line flushing, and hydrant flushing.

Vehicle and Equipment Cleaning (NS-8)

All vehicles and equipment that regularly enter and leave the construction site must be cleaned offsite. When vehicle and equipment washing and cleaning must occur onsite, and the operation cannot be located within a structure or building equipped with appropriate disposal facilities, the outside cleaning area should have the following characteristics:

- Located away from storm drain inlets, drainage facilities, or watercourses Vehicle and Equipment Fueling
- Paved with concrete or asphalt and bermed to contain wash waters and to prevent run on and run off
- Configured with a sump to allow collection and disposal of wash water
- No discharge of wash waters to storm drains or watercourses
- Used only when necessary

Vehicle and Equipment Fueling (NS-9)

Vehicle equipment fueling procedures and practices will be used to prevent fuel spills and leaks, and reduce or eliminate contamination of stormwater. This can be accomplished by using offsite facilities, fueling in designated areas only, enclosing or covering stored fuel, implementing spill controls, and training employees and subcontractors in proper fueling procedures.

Onsite vehicle and equipment fueling should only be used where it is impractical to send vehicles and equipment offsite for fueling. A dedicated fueling area will be designated at the project site. The dedicated fueling area will be located on a level-grade area located at least 50 feet away from downstream drainage facilities and watercourses. The dedicated fueling area will be protected with berms and/or dikes to prevent run-on and runoff and to contain spills.

Vehicle and Equipment Maintenance (NS-10)

Contractor will prevent or reduce the contamination of stormwater resulting from vehicle and equipment maintenance by running a “dry and clean site”. The best option would be to perform maintenance activities at an offsite facility. If this option is not available then work should be performed in designated areas only, while providing cover for materials stored outside, checking for leaks and spills, and containing and cleaning up spills immediately. Employees and subcontractors must be trained in proper procedures.

Concrete Curing (NS-12)

Proper procedures and care should be taken when managing concrete curing materials to prevent them from coming into contact with stormwater flows, which could result in a high PH discharge.

Concrete Finishing (NS-13)

Proper procedures and appropriate BMPs shall be implemented to minimize the impact that concrete finishing methods may have on runoff. The Contractor shall collect and properly dispose of water and solid waste from concrete finishing. All drain inlets within the concrete finishing operations shall be protected before these operations start.

3.3.2 Materials Management and Waste Management

Materials management control practices consist of implementing procedural and structural BMPs for handling, storing and using construction materials to prevent the release of those materials into stormwater discharges. The amount and type of construction materials to be utilized at the Site will depend upon the type of construction and the length of the construction period. The materials may be used continuously, such as fuel for vehicles and equipment, or the materials may be used for a discrete period, such as soil binders for temporary stabilization.

Waste management consist of implementing procedural and structural BMPs for handling, storing and ensuring proper disposal of wastes to prevent the release of those wastes into stormwater discharges.

Materials and waste management pollution control BMPs shall be implemented to minimize stormwater contact with construction materials, wastes and service areas; and to prevent materials and wastes from being discharged off-site. The primary mechanisms for stormwater contact that shall be addressed include:

- Direct contact with precipitation

- Contact with stormwater run-on and runoff
- Wind dispersion of loose materials
- Direct discharge to the storm drain system through spills or dumping
- Extended contact with some materials and wastes, such as asphalt cold mix and treated wood products, which can leach pollutants into stormwater.

A list of construction activities is provided in Section 2.6. The following Materials and Waste Management BMP selection table indicates the BMPs that shall be implemented to handle materials and control construction site wastes associated with these construction activities. Fact Sheets for Materials and Waste Management BMPs are provided in Appendix H.

Table 3.5 Temporary Materials Management BMPs

CASQA Fact Sheet	BMP Name	Meets a Minimum Requirement ⁽¹⁾	BMP used		If not used, state reason
			YES	NO	
WM-01	Material Delivery and Storage	✓	Y		
WM-02	Material Use	✓	Y		
WM-03	Stockpile Management	✓	Y		
WM-04	Spill Prevention and Control	✓	Y		
WM-05	Solid Waste Management	✓	Y		
WM-06	Hazardous Waste Management	✓	Y		
WM-07	Contaminated Soil Management			N	Not anticipated for this project
WM-08	Concrete Waste Management	✓	Y		
WM-09	Sanitary-Septic Waste Management	✓	Y		
WM-10	Liquid Waste Management		Y		
Alternate BMPs Used:				If used, state reason:	
⁽¹⁾ Applicability to a specific project shall be determined by the QSD.					

Material management BMPs shall be implemented in conformance with the following guidelines and in accordance with the BMP Fact Sheets provided in Appendix H. If there is a conflict between documents, the Site Map will prevail over narrative in the body of the SWPPP or guidance in the BMP Fact Sheets. Site specific details in the Site Map prevail over standard details included in the Site Map. The narrative in the body of the SWPPP prevails over guidance in the BMP Fact Sheets.

Material Delivery and Storage (WM-1)

Contractor will prevent, reduce, or eliminate the discharge of pollutants from material delivery and storage to the stormwater system or watercourses by minimizing the storage of hazardous materials onsite, storing materials in watertight containers and/or a completely enclosed designated area, installing secondary containment, conducting regular inspections, and training employees and subcontractors.

Material Use (WM-2)

Discharge of pollutants to the storm drain system or watercourses from material use will be prevented or reduced by using alternative products, minimizing hazardous material use onsite, and training employees and subcontractors.

Stockpile Management (WM-3)

Stockpile management procedures and practices will be used to reduce or eliminate air and stormwater pollution from stockpiles of soil, soil amendments, sand, paving materials such as portland cement concrete (PCC) rubble, asphalt concrete (AC), asphalt concrete rubble, aggregate base, aggregate sub base or pre-mixed aggregate, asphalt minder (so called “cold mix” asphalt), and pressure treated wood.

Spill Prevention and Control (WM-4)

Discharge of pollutants to drainage systems or watercourses from leaks and spills shall be prevented or reduced by reducing the chance for spills, stopping the source of spills, containing and cleaning up spills, properly disposing of spill materials, and training employees.

Solid Waste Management (WM-5)

Solid waste management procedures and practices will be implemented to prevent or reduce the discharge of pollutants to stormwater from solid or construction waste by providing designated waste collection areas and containers, arranging for regular disposal, and training employees and subcontractors.

Hazardous Waste Management (WM-6)

Discharge of pollutants to stormwater from hazardous waste will be prevented or reduced through proper material use, waste disposal, and training of employees and subcontractors. Hazardous waste management practices will be implemented on construction activities that generate waste from the use of:

- Petroleum products
- Asphalt products
- Septic wastes
- Pesticides

- Paints
- Concrete curing products
- Any materials deemed a hazardous waste in California, Title 22 Division 4.5

Sanitary-Septic Waste Management (WM-9)

Proper sanitary and septic waste management shall be used to prevent the discharge of pollutants to stormwater from sanitary and septic waste by providing convenient, well-maintained facilities, and arranging for regular service and disposal.

Concrete Waste Management (WM-8)

Discharge of pollutants to stormwater from concrete waste will be prevented by conducting washout onsite or offsite in a designated area, and by employee and subcontractor training. Many types of construction materials, including mortar, concrete, stucco, cement and block and their associated wastes have basic chemical properties that can raise pH levels outside of the permitted range. Additional care should be taken when managing these materials to prevent them from coming into contact with stormwater flows and raising pH to levels outside the accepted range.

Liquid Waste Management (WM-10)

Liquid waste management procedures and practices will be implemented to prevent discharge of pollutants to the storm drain system or to watercourses as a result of the creation, collection, and disposal of non-hazardous liquid wastes.

3.4 POST CONSTRUCTION STORMWATER MANAGEMENT MEASURES

Post construction BMPs are permanent measures installed during construction, designed to reduce or eliminate pollutant discharges from the site after construction is completed.

This site is located in an area subject to a Phase I or Phase II Municipal Separate Storm Sewer System (MS4) permit approved Stormwater Management Plan. Yes No

Post construction maintenance of this project will be executed by the LRP through the environmental permit mandates.

On 19 April 2018, the City of Clovis, City of Fresno, County of Fresno, California State University, Fresno, and Fresno Metropolitan Flood Control District submitted Notices of Intent (NOIs) to obtain coverage under the General Permit for Discharges from Municipal Separate Storm Sewer Systems (MS4), Order R5-2016-0040 (General Permit). Central Valley Regional Water Quality Control Board (Central Valley Water Board) has determined that they qualify for coverage under the General Order

Section 4 BMP Inspection, Maintenance and Rain Event Action Plans

4.1 BMP INSPECTION AND MAINTENANCE

The General Permit requires routine weekly inspections of BMPs, along with inspections before, during, and after qualifying rain events. A BMP inspection checklist must be filled out for inspections and maintained on-site with the SWPPP. The inspection checklist includes the necessary information covered in Section 7.6. A blank inspection checklist can be found in Appendix I. Completed checklists shall be kept in CSMP Attachment 2 “Monitoring Records.

BMPs shall be maintained regularly to ensure proper and effective functionality. If necessary, corrective actions shall be implemented within 72 hours of identified deficiencies and associated amendments to the SWPPP shall be prepared by the QSD.

Specific details for maintenance, inspection, and repair of Construction Site BMPs can be found in the BMP Factsheets in Appendix H.

4.2 RAIN EVENT ACTION PLANS

The Rain Event Action Plans (REAP) is written document designed to be used as a planning tool by the QSP to protect exposed portions of project sites and to ensure that the discharger has adequate materials, staff, and time to implement erosion and sediment control measures. These measures are intended to reduce the amount of sediment and other pollutants that could be generated during the rain event. It is the responsibility of the QSP to be aware of precipitation forecast and to obtain and print copies of forecasted precipitation from NOAA’s National Weather Service Forecast Office.

The SWPPP includes REAP templates but the QSP will need to customize them for each rain event. Site-specific REAP templates for each applicable project phase can be found in Appendix J. The QSP shall maintain a paper copy of completed REAPs in compliance with the record retention requirements Section 1.5 of this SWPPP. Completed REAPs shall be maintained in Appendix J.

The QSP will develop an event specific REAP 48 hours in advance of a precipitation event forecast to have a 30% or greater chance of producing precipitation in the project area. The REAP will be onsite and be implemented 24 hours in advance of any the predicted precipitation event.

At minimum the REAP will include the following site and phase-specific information:

1. Site Address;
2. Calculated Risk Level (2 or 3);
3. Site Stormwater Manager Information including the name, company and 24-hour emergency telephone number;
4. Erosion and Sediment Control Provider information including the name, company and 24-hour emergency telephone number;

5. Stormwater Sampling Agent information including the name, company, and 24-hour emergency telephone number;
6. Activities associated with each construction phase;
7. Trades active on the construction site during each construction phase;
8. Trade contractor information; and
9. Recommended actions for each project phase.

Section 5 Training

Appendix L identifies the QSPs for the project. To promote stormwater management awareness specific for this project, periodic training of job-site personnel shall be included as part of routine project meetings (e.g. daily/weekly tailgate safety meetings), or task specific trainings as needed.

The QSP shall be responsible for providing this information at the meetings, and subsequently completing the training logs shown in Appendix K, which identifies the site-specific stormwater topics covered as well as the names of site personnel who attended the meeting. Tasks may be delegated to trained employees by the QSP provided adequate supervision and oversight is provided. Training shall correspond to the specific task delegated including: SWPPP implementation; BMP inspection and maintenance; and record keeping.

Documentation of training activities (formal and informal) is retained in SWPPP Appendix K.

Section 6 Responsible Parties and Operators

6.1 RESPONSIBLE PARTIES

Approved Signatory(ies) who are responsible for SWPPP implementation and have authority to sign permit-related documents [is/are] listed below. Written authorizations from the LRP for these individuals are provided in Appendix L. The Approved Signatory(ies) assigned to this project [is/are]:

Name	Title	Phone Number
Matt Ambroziak		

QSPs identified for the project are identified in Appendix L. The QSP shall have primary responsibility and significant authority for the implementation, maintenance and inspection/monitoring of SWPPP requirements. The QSP will be available at all times throughout the duration of the project. Duties of the QSP include but are not limited to:

- Implementing all elements of the General Permit and SWPPP, including but not limited to:
 - Ensuring all BMPs are implemented, inspected, and properly maintained;
 - Performing non-stormwater and stormwater visual observations and inspections;
 - Performing non-stormwater and storm sampling and analysis, as required;
 - Performing routine inspections and observations;
 - Implementing non-stormwater management, and materials and waste management activities such as: monitoring discharges; general Site clean-up; vehicle and equipment cleaning, fueling and maintenance; spill control; ensuring that no materials other than stormwater are discharged in quantities which will have an adverse effect on receiving waters or storm drain systems; etc.;
- The QSP may delegate these inspections and activities to an appropriately trained employee, but shall ensure adequacy and adequate deployment.
- Ensuring elimination of unauthorized discharges.
- The QSPs shall be assigned authority by the LRP to mobilize crews in order to make immediate repairs to the control measures.
- Coordinate with the Contractor(s) to assure all of the necessary corrections/repairs are made immediately and that the project complies with the SWPPP, the General Permit and approved plans at all times.

- Notifying the LRP or Authorized Signatory immediately of off-site discharges or other non-compliance events.
- The QSP shall be assigned authority by the Corps Regulatory Parties to mobilize crews in order to make immediate repairs to the control measures.

6.2 CONTRACTOR LIST

Contractor

Herback General Engineering
2531 Nowlin Road, Minden, Nevada 89423
Phone: (775) 267-6800

Qualified SWPPP Developer (QSD):

Zila
Mohammad Arhami, PhD, PE, QSD C72853
10880 Wilshire Blvd, Suite 1101, CA 90024
Phone: 323-455-5012

Qualified SWPPP Practitioner (QSP):

Herback General Engineering
Greg Herback, QSP
2531 Nowlin Road, Minden, NV 89423
Phone: 775-690-8941

Section 7 Construction Site Monitoring Program

7.1 Purpose

This Construction Site Monitoring Program was developed to address the following objectives:

1. To demonstrate that the site is in compliance with the Discharge Prohibitions and Numeric Action Levels (NALs) of the Construction General Permit;
2. To determine whether non-visible pollutants are present at the construction site and are causing or contributing to exceedances of water quality objectives;
3. To determine whether immediate corrective actions, additional Best Management Practices (BMP) implementation, or SWPPP revisions are necessary to reduce pollutants in stormwater discharges and authorized non-stormwater discharges;
4. To determine whether BMPs included in the SWPPP are effective in preventing or reducing pollutants in stormwater discharges and authorized non-stormwater discharges.

7.2 Applicability of Permit Requirements

This project has been determined to be a Risk Level 3 project. The General Permit identifies the following types of monitoring as being applicable for a Risk Level 3 project. The QSP shall within 3 days of the storm water inspection, submit copies of the completed inspection report to Corps Construction Rep, Larry Romero or David Leon.

Risk Level 3 Requirements:

- Visual inspections of BMPs;
- Visual monitoring of the site related to qualifying storm events;
- Visual monitoring of the site for non-stormwater discharges;
- Sampling and analysis of construction site runoff for pH and turbidity;
- Sampling and analysis of construction site runoff for other parameters if applicable;
- Sampling and analysis of receiving waters if applicable;
- Sampling and analysis of non-stormwater discharges;
- Sampling and analysis of construction site runoff for non-visible pollutants when applicable;
- Sampling and analysis of non-stormwater discharges when applicable; and
- Bioassessment monitoring if applicable.

7.3. Weather and Rain Event Tracking

Visual monitoring and inspections requirements of the General Permit are triggered by a qualifying rain event. The General Permit defines a qualifying rain event as any event that produces ½ inch of precipitation. A minimum of 48 hours of dry weather will be used to distinguish between separate qualifying storm events.

Visual monitoring, inspections, and sampling requirements of the General Permit are triggered by a qualifying rain event. The General Permit defines a qualifying rain event as any event that produces ½ inch of precipitation. A minimum of 48 hours of dry weather will be used to distinguish between separate qualifying storm events.

For the purposes of assessing exceptions to the Receiving Water Monitoring Triggers the General Permit establishes the compliance storm event at the 5-year, 24-hour event.

7.3.1 Weather Tracking

The QSP should daily consult the National Oceanographic and Atmospheric Administration (NOAA) for the weather forecasts. These forecasts can be obtained at <http://www.srh.noaa.gov/>. Weather reports should be printed and maintained with the SWPPP in CSMP Attachment 1 “Weather Reports”.

7.3.2 Rain Gauges

The QSP shall install 1 rain gauge(s) on the project site. Locate the gauge in an open area away from obstructions such as trees or overhangs. Mount the gauge on a post at a height of 3 to 5 feet with the gauge extending several inches beyond the post. Make sure that the top of the gauge is level. Make sure the post is not in an area where rainwater can indirectly splash from sheds, equipment, trailers, etc.

The rain gauge(s) shall be read daily during normal site scheduled hours. The rain gauge should be read at approximately the same time every day and the date and time of each reading recorded. Log rain gauge readings in CSMP Attachment 1 “Weather Records”. Follow the rain gauge instructions to obtain accurate measurements.

Once the rain gauge reading has been recorded, accumulated rain shall be emptied and the gauge reset.

For comparison with the site rain gauge, the nearest appropriate governmental rain gauge(s) is located at Emigrant Gap, Blue Canyon Nyack Airport (KBLU).

7.4 Monitoring Locations

Monitoring locations are shown on the Site Maps in Appendix B. Monitoring locations are described in the Sections 7.6 and 7.7.

Whenever changes in the construction site might affect the appropriateness of sampling locations, the sampling locations shall be revised accordingly. All such revisions shall be implemented as soon as feasible and the SWPPP amended. Temporary changes that result in a one-time additional sampling location do not require a SWPPP amendment.

7.5 Safety and Monitoring Exemptions

This project is not required to collect samples or conduct visual observations (inspections) under the following conditions:

- During dangerous weather conditions such as flooding and electrical storms.
- Outside of scheduled site business hours.

If monitoring (visual monitoring or sample collection) of the site is unsafe because of the dangerous conditions noted above then the QSP shall document the conditions for why an exception to performing the monitoring was necessary. The exemption documentation shall be filed in CSMP Attachment 2 “Monitoring Records”.

7.6 Visual Monitoring

Visual monitoring includes observations and inspections. Inspections of BMPs are required to identify and record BMPs that need maintenance to operate effectively, that have failed, or that could fail to operate as intended. Visual observations of the site are required to observe storm water drainage areas to identify any spills, leaks, or uncontrolled pollutant sources.

Table 7.1 identifies the required frequency of visual observations and inspections. Inspections and observations will be conducted at the locations identified in Section 7.6.3.

Table 7.1 Summary of Visual Monitoring and Inspections	
Type of Inspection	Frequency
<i>Routine Inspections</i>	
BMP Inspections	Weekly ¹
BMP Inspections – Tracking Control	Daily
Non-Stormwater Discharge Observations	Quarterly during daylight hours
<i>Rain Event Triggered Inspections</i>	
Site Inspections Prior to a Qualifying Event	Within 48 hours of a qualifying event ²
BMP Inspections During an Extended Storm Event	Every 24-hour period of a rain event ³
Site Inspections Following a Qualifying Event	Within 48 hours of a qualifying event ²
¹ Most BMPs must be inspected weekly; those identified below must be inspected more frequently. ² Inspections are required during scheduled site operating hours. ³ Inspections are required during scheduled site operating hours regardless of the amount of precipitation on any given day.	

7.6.1 Routine Observations and Inspections

Routine site inspections and visual monitoring are necessary to ensure that the project is in compliance with the requirements of the Construction General Permit.

7.6.1.1 Routine BMP Inspections

Inspections of BMPs are conducted to identify and record:

- BMPs that are properly installed;
- BMPs that need maintenance to operate effectively;
- BMPs that have failed; or
- BMPs that could fail to operate as intended.

7.6.1.2 Non-Stormwater Discharge Observations

Each drainage area will be inspected for the presence of or indications of prior unauthorized and authorized non-stormwater discharges. Inspections will record:

- Presence or evidence of any non-stormwater discharge (authorized or unauthorized);
- Pollutant characteristics (floating and suspended material, sheen, discoloration, turbidity, odor, etc.); and

- Source of discharge.

7.6.2 Rain-Event Triggered Observations and Inspections

Visual observations of the site and inspections of BMPs are required prior to a qualifying rain event; following a qualifying rain event, and every 24-hour period during a qualifying rain event. Pre-rain inspections will be conducted after consulting NOAA and determining that a precipitation event with a 50% or greater probability of precipitation has been predicted.

7.6.2.1 Visual Observations Prior to a Forecasted Qualifying Rain Event

Within 48-hours prior to a qualifying event a stormwater visual monitoring site inspection will include observations of the following locations:

- Stormwater drainage areas to identify any spills, leaks, or uncontrolled pollutant sources;
- BMPs to identify if they have been properly implemented;
- Any stormwater storage and containment areas to detect leaks and ensure maintenance of adequate freeboard.

BMP inspections and visual monitoring will be triggered by a NOAA prediction of rain in the project area.

or

Consistent with guidance from the State Water Resources Control Board, pre-rain BMP inspections and visual monitoring will be triggered by a NOAA forecast that indicates a probability of precipitation of 50% or more in the project area.

or

BMP inspections and visual monitoring will be triggered by a NOAA quantitative predicted forecast (QPF) that indicates ½-inch or more of rain will occur in the project area.

7.6.2.2 BMP Inspections During an Extended Storm Event

During an extended rain event BMP inspections will be conducted to identify and record:

- BMPs that are properly installed;
- BMPs that need maintenance to operate effectively;
- BMPs that have failed; or
- BMPs that could fail to operate as intended.

If the construction site is not accessible during the rain event, the visual inspections shall be performed at all relevant outfalls, discharge points, downstream locations. The inspections should record any projected maintenance activities.

7.6.2.3 Visual Observations Following a Qualifying Rain Event

Within 48 hours following a qualifying rain event (0.5 inches of rain) a stormwater visual monitoring site inspection is required to observe:

- Stormwater drainage areas to identify any spills, leaks, or uncontrolled pollutant sources;
- BMPs to identify if they have been properly designed, implemented, and effective;
- Need for additional BMPs;

- Any stormwater storage and containment areas to detect leaks and ensure maintenance of adequate freeboard; and
- Discharge of stored or contained rain water.

7.6.3 Visual Monitoring Procedures

Visual monitoring shall be conducted by the QSP or staff trained by and under the supervision of the QSP.

The name(s) and contact number(s) of the site visual monitoring personnel are listed below and their training qualifications are provided in Appendix K.

Assigned inspector: Greg Herback Contact phone: 775-690-8941

Alternate inspector: Contact phone:

Stormwater observations shall be documented on the *Visual Inspection Field Log Sheet* (see CSMP Attachment 3 “Example Forms”). BMP inspections shall be documented on the site specific BMP inspection checklist. Any photographs used to document observations will be referenced on stormwater site inspection report and maintained with the Monitoring Records in Attachment 2.

The completed reports will be kept in CSMP Attachment 2 “Monitoring Records”.

7.6.4 Visual Monitoring Follow-Up and Reporting

Correction of deficiencies identified by the observations or inspections, including required repairs or maintenance of BMPs, shall be initiated and completed as soon as possible.

If identified deficiencies require design changes, including additional BMPs, the implementation of changes will be initiated within 72 hours of identification and be completed as soon as possible. When design changes to BMPs are required, the SWPPP shall be amended to reflect the changes.

Deficiencies identified in site inspection reports and correction of deficiencies will be tracked on the *Inspection Field Log Sheet* or *BMP Inspection Report* and shall be submitted to the QSP and shall be kept in CSMP Attachment 2 “Monitoring Records”.

The QSP shall within 2 days of the inspection submit copies of the completed *Inspection Field Log Sheet* or *BMP Inspection Report* with the corrective actions.

The QSP shall within 3 days of the storm water inspection, submit copies of the completed inspection report to Corps Construction Rep, Harlan Jefferson and Larry Romero.

Results of visual monitoring must be summarized and reported in the Annual Report.

7.6.5 Visual Monitoring Locations

The inspections and observations identified in Sections 7.6.1 and 7.6.2 will be conducted at the locations identified in this section.

BMP locations are shown on the Site Maps in SWPPP Appendix B.

There are 2 drainage area(s) on the project site and the contractor’s yard, staging areas, and storage areas. Table 7.2 identifies each drainage area by location.

Table 7.2 Site Drainage Areas

Location No.	Location
1	Contractor’s Staging Area
2	Contractor’s project site

There are 0 stormwater storage or containment area(s) are on the project site. Stormwater storage or containment area(s) are shown on the Site Maps in Appendix B and Table 7.3 identifies each stormwater storage or containment area by location.

Table 7.3 Stormwater Storage and Containment Areas

Location No.	Location

Storm Drain Inlets are discharge location(s) on the project site. Site stormwater discharge location(s) are shown on the Site Maps in Appendix B and Table 7.4 identifies each stormwater discharge location.

Table 7.4 Site Stormwater Discharge Locations

Location No.	Location
	@Storm Drain Inlets

7.7 Water Quality Sampling and Analysis

7.7.1 *Sampling and Analysis Plan for Non-Visible Pollutants in Stormwater Runoff Discharges*

This Sampling and Analysis Plan for Non-Visible Pollutants describes the sampling and analysis strategy and schedule for monitoring non-visible pollutants in stormwater runoff discharges from the project site.

Sampling for non-visible pollutants will be conducted when (1) a breach, leakage, malfunction, or spill is observed; and (2) the leak or spill has not been cleaned up prior to the rain event; and (3) there is the potential for discharge of non-visible pollutants to surface waters or drainage system.

The following construction materials, wastes, or activities, as identified in Section 2.6, are potential sources of non-visible pollutants to stormwater discharges from the project.

- Paving & Grinding Operation
- Portland cement and masonry products
- Painting products for striping and marking
- Chemical waste from stationary toilets
- Vehicle and equipment fueling and batteries
- Concrete washout
- General site litter

The following existing site features are potential sources of non-visible pollutants to stormwater discharges from the project. Locations of existing site features contaminated with non-visible pollutants are shown on the Site Maps in Appendix B.

- None

The following soil amendments have the potential to change the chemical properties, engineering properties, or erosion resistance of the soil and will be used on the project site.

- None

The project has the potential to receive stormwater run-on from the following locations with the potential to contribute non-visible pollutants to stormwater discharges from the project.

- None

7.7.1.1 *Sampling Schedule*

Samples for the potential non-visible pollutant(s) and a sufficiently large unaffected background sample shall be collected during the first two hours of discharge from rain events that result in a sufficient discharge for sample collection. Samples shall be collected during the site's scheduled hours and shall be collected regardless of the time of year and phase of the construction.

Collection of discharge samples for non-visible pollutant monitoring will be triggered when any of the following conditions are observed during site inspections conducted prior to or during a rain event.

- Materials or wastes containing potential non-visible pollutants are not stored under watertight conditions. Watertight conditions are defined as (1) storage in a watertight container, (2) storage under a watertight roof or within a building, or (3) protected by temporary cover and containment that prevents stormwater contact and runoff from the storage area.
- Materials or wastes containing potential non-visible pollutants are stored under watertight conditions, but (1) a breach, malfunction, leakage, or spill is observed, (2) the leak or spill is not cleaned up prior to the rain event, and (3) there is the potential for discharge of non-visible pollutants to surface waters or a storm drain system.
- A construction activity, including but not limited to those in Section 2.6, with the potential to contribute non-visible pollutants (1) was occurring during or within 24 hours prior to the rain event, (2) BMPs were observed to be breached, malfunctioning, or improperly implemented, and (3) there is the potential for discharge of non-visible pollutants to surface waters or a storm drain system.
- Soil amendments that have the potential to change the chemical properties, engineering properties, or erosion resistance of the soil have been applied, and there is the potential for discharge of non-visible pollutants to surface waters or a storm drain system.
- Stormwater runoff from an area contaminated by historical usage of the site has been observed to combine with stormwater runoff from the site, and there is the potential for discharge of non-visible pollutants to surface waters or a storm drain system.

7.7.1.2 *Sampling Locations*

Sampling locations are based on proximity to planned non-visible pollutant storage, occurrence or use; accessibility for sampling, and personnel safety. Planned non-visible pollutant sampling locations are shown on the Site Maps in Appendix B and include the locations identified in Tables 7.5 through 7.9.

13 Sampling location(s) on the project site and the contractor’s yard have been identified for the collection of samples of runoff from planned material and waste storage areas and areas where non-visible pollutant producing construction activities are planned.

Table 7.5 Non-Visible Pollutant Sample Locations – Contractors’ Yard		
Sample Location Number	Sample Location Description	Sample Location Latitude and Longitude (Decimal Degrees)
1	Downstream of project site (See WP-6)	
2	Downstream of staging area (See WP-2)	
3-13	At storm drain inlets (See WP-3, WP-4 & WP-5)	

0 sampling locations have been identified for the collection of samples of runoff from drainage areas where soil amendments will be applied that have the potential to affect water quality.

Table 7.6 Non-Visible Pollutant Sample Locations – Soil Amendment Areas		
Sample Location Number	Sample Location	Sample Location Latitude and Longitude (Decimal Degrees)

0 sampling locations have been identified for the collection of samples of runoff from drainage areas contaminated by historical usage of the site.

Table 7.7 Non-Visible Pollutant Sample Locations – Areas of Historical Contamination		
Sample Location Number	Sample Location	Sample Location Latitude and Longitude (Decimal Degrees)

1 sampling location(s) has been identified for the collection of an uncontaminated sample of runoff as a background sample for comparison with the samples being analyzed for non-visible pollutants. This location(s) was selected such that the sample will not have come in contact with the operations, activities, or areas identified in Section 7.7.1 or with disturbed soils areas.

Table 7.8 Non-Visible Pollutant Sample Locations – Background (Unaffected Sample)		
Sample Location Number	Sample Location	Sample Location Latitude and Longitude (Decimal Degrees)
1	Exact Location to be determine by QSP on site	

3 sampling locations have been identified for the collection of samples of run-on to the project site. Run-on from these locations has the potential to combine with discharges from the site being sampled for non-visible pollutants. These samples are intended to identify potential sources of non-visible pollutants that originate off the project site.

Table 7.9 Non-Visible Pollutant Sample Locations – Site Run-On		
Sample Location Number	Sample Location	Sample Location Latitude and Longitude (Decimal Degrees)
1-2	Upstream of project site (See WP-3 and WP-4)	
3	Upstream of staging area (WP-2)	

If a stormwater visual monitoring site inspection conducted prior to or during a storm event identifies the presence of a material storage, waste storage, or operations area with spills or the potential for the discharge of non-visible pollutants to surface waters or a storm drain system that is at a location not listed above and has not been identified on the Site Maps, sampling locations will be selected by the QSP using the same rationale as that used to identify planned locations. Non-visible pollutant sampling locations shall be identified by the QSP on the pre-rain event inspection form and/or Rain Event Action Plan prior to a forecasted qualifying rain event.

7.7.1.3 *Monitoring Preparation*

Non-visible pollutant samples will be collected by:

- Contractor Yes No
 Consultant Yes No
 Laboratory Yes No

Samples on the project site will be collected by the following contractor sampling personnel:

Name/Telephone Number: Greg Herback / 775-690-8941

Alternate(s)/Telephone Number:

An adequate stock of monitoring supplies and equipment for monitoring non-visible pollutants will be available on the project site prior to a sampling event. Monitoring supplies and equipment will be stored in a cool temperature environment that will not come into contact with rain or direct sunlight. Sampling personnel will be available to collect samples in accordance with the sampling schedule. Supplies maintained at the project site will include, but are not limited to, clean powder-free nitrile gloves, sample collection equipment, coolers, appropriate number and volume of sample bottles, identification labels, re-sealable storage bags, paper towels, personal rain gear, ice, and *Effluent Sampling Field Log Sheets* and Chain of Custody (CoC) forms, which are provided in CSMP Attachment 3 “Example Forms”.

Samples on the project site will be collected by the following:

Company Name: Herback General Engineering

Street Address: 2531 Nowlin Road

City, State Zip: Minden, NV 89423

Telephone Number: 775-690-8941

Point of Contact:

Name of Sampler(s): Greg Herback, QSP

Name of Alternate(s):

The QSP or his/her designee will contact the lab 24 hours prior to a predicted rain event or for an unpredicted event, as soon as a rain event begins if one of the triggering conditions is identified during an inspection to ensure that adequate sample collection personnel and supplies for monitoring non-visible pollutants are available and will be mobilized to collect samples on the project site in accordance with the sampling schedule.

7.7.1.4 Analytical Constituents

Table 7.10 lists the specific sources and types of potential non-visible pollutants on the project site and the water quality indicator constituent(s) for that pollutant.

Table 7.10 Potential Non-Visible Pollutants and Water Quality Indicator Constituents

Pollutant Source	Pollutant	Water Quality Indicator Constituent
Concrete Curing Compounds	VOCs, SVOCs, PH	VOCs
Landscaping	Pesticides/Herbicides Fertilizers Aluminum sulfate Vegetation stockpiles	Product dependent TKN, NO3, NH3, Phosphate Al, TDS, Sulfate BOD

Table 7.10 Potential Non-Visible Pollutants and Water Quality Indicator Constituents

Pollutant Source	Pollutant	Water Quality Indicator Constituent
Painting/Striping	Resins	COD, SVOCs, metals
	Thinners	COD, VOCs
	Paint strippers	SVOCs, VOCs, Metals
	Lacquers, varnishes, enamels	COD, SVOCs, VOCs
	Sealants	COD
	Adhesives	SVOCs, COD
Sanitary Waste	Portable Toilets	BOD, Total/Fecal coliform
Vehicle Fluids	Oil, grease, coolant	Refer to Laboratory
Batteries	Sulfuric Acid, PH, Lead	Sulfate, Lead

7.7.1.5 Sample Collection

Samples of discharge shall be collected at the designated non-visible pollutant sampling locations shown on the Site Maps in Appendix B or in the locations determined by observed breaches, malfunctions, leakages, spills, operational areas, soil amendment application areas, and historical site usage areas that triggered the sampling event.

Grab samples shall be collected and preserved in accordance with the methods identified in the Table, “Sample Collection, Preservation and Analysis for Monitoring Non-Visible Pollutants” provided in Section 7.7.1.6. Only the QSP, or personnel trained in water quality sampling under the direction of the QSP shall collect samples.

Sample collection and handling requirements are described in Section 7.7.7.

7.7.1.6 Sample Analysis

Samples shall be analyzed using the analytical methods identified in the Table 7.11.

Samples will be analyzed by:

Laboratory Name: WETLAB - Western Environmental Testing Laboratory

Street Address: 475 E. Greg St, Suite 119

City, State Zip: Sparks, NV 89431

Telephone Number: (775) 355-0202

Point of Contact:

ELAP Certification
Number:

Samples will be delivered to the laboratory by:

Driven by Contractor Yes No

Picked up by Laboratory Courier Yes No
Shipped Yes No

Table 7.11 Sample Collection, Preservation and Analysis for Monitoring Non-Visible Pollutants

Constituent	Analytical Method	Minimum Sample Volume	Sample Containers	Sample Preservation	Reporting Limit	Maximum Holding Time
Methyl Methacrylate (MMA)	EPA 625.2 L	1000 ml	glass	Store at 4° C	10 ug/L	14 days
Chlorine	SM 4500	500 mL	Polypropylene	Do not expose to light	0.1 mg/L	Immediate
CODs	EPA410.4	20 ml	250 ml glass	Store at 4° C, H2So4	10.0 mg/L	28 days
Nitrate	EPA300.0	500 mL	PE or glass	Store at 4° C	0.1 mg/L	14 days
Nitrogen	EPA351.3	100 mL	Glass	Store at 4° C	0.1 mg/L	28 days
VOCs	EPA 8260B	3 x 40 ml	Amber Glass	Store at 4° C, HCL to pH<2	1 ug/L	14 days
TOCs	EPA415.1 (TOC)	150 ml	250 ml glass	Store at 4° C, H2So4	1 mg/L	28 days
Herbicide	EPA 8151A	1000 ml	1 L amber glass	Store at 4° C	1 ug/L	7 days
Phenols	EPA 420.1 (Phenol)	500 ml	500 ml amber glass	Store at 4° C, H2So4	0.1 mg/L	28 days
Sulfate	EPA300.0	250 ml	Polypropylene	Store at 4° C	0.1 mg/L	28 days
Metals	EPA200.8	250 ml	Polypropylene	Store at 4° C, HNO3 to pH<2	0.2 mg/L	6 months
Notes:						

7.7.1.7 Data Evaluation and Reporting

The QSP shall complete an evaluation of the water quality sample analytical results.

Runoff/downgradient results shall be compared with the associated upgradient/unaffected results and any associated run-on results. Should the runoff/downgradient sample show an increased level of the tested analyte relative to the unaffected background sample, which cannot be explained by run-on results, the BMPs, site conditions, and surrounding influences shall be assessed to determine the probable cause for the increase.

As determined by the site and data evaluation, appropriate BMPs shall be repaired or modified to mitigate discharges of non-visible pollutant concentrations. Any revisions to the BMPs shall be recorded as an amendment to the SWPPP.

The General Permit prohibits the storm water discharges that contain hazardous substances equal to or in excess of reportable quantities established in 40 C.F.R. §§ 117.3 and 302.4. The results of any non-stormwater discharge results that indicate the presence of a hazardous substance in excess of established reportable quantities shall be immediately reported to the Regional Water Board and other agencies as required by 40 C.F.R. §§ 117.3 and 302.4.

Results of non-visible pollutant monitoring shall be reported in the Annual Report.

7.7.2 Sampling and Analysis Plan for pH and Turbidity in Stormwater Runoff Discharges

Sampling and analysis of runoff for pH and turbidity is required for Risk Level 3 Projects. This Sampling and Analysis Plan describes the strategy for monitoring turbidity and pH levels of stormwater runoff discharges from the project site and run-on that may contribute to an exceedance of a Numeric Action Level (NAL).

Samples for turbidity will be collected from all drainage areas with disturbed soil areas and samples for pH will be collected from all drainage areas with a high risk of pH altering discharge.

7.7.2.1 Sampling Schedule

Stormwater runoff samples shall be collected for turbidity from each day of a qualifying rain event that results in a discharge from the project site. At minimum, turbidity samples will be collected from each site discharge location draining a disturbed area. A minimum of three samples will be collected per day of discharge during a qualifying event. Samples should be representative of the total discharge from the project each day of discharge during the qualifying event. Typically representative samples will be spaced in time throughout the daily discharge event.

Stormwater runoff samples shall be collected for pH from each day of qualifying rain events that result in a discharge from the project site. Note that pH samples are only required to be collected during project phases and from drainage areas with a high risk of pH altering discharge. A minimum of three samples will be collected per day of discharge during a qualifying event. Samples should be representative of the total discharge from the location each day of discharge

during the qualifying event. Typically representative samples will be spaced in time throughout the daily discharge event.

Stored or collected water from a qualifying storm event when discharged shall be tested for turbidity and pH (when applicable). Stored or collected water from a qualifying event may be sampled at the point it is released from the storage or containment area or at the site discharge location.

Run-on samples shall be collected whenever the QSP identifies that run-on has the potential to contribute to an exceedance of a NAL.

7.7.2.2 Sampling Locations

Sampling locations are based on the site runoff discharge locations and locations where run-on enters the site; accessibility for sampling; and personnel safety. Planned pH and turbidity sampling locations are shown on the Site Maps in Appendix B and include the locations identified in Table 7.13 and Table 7-14.

13 sampling location(s) on the project site and the contractor’s staging area have been identified for the collection of runoff samples. Table 7.12 also provides an estimate of the site’s area that drains to each location (same as defined Table 7.5).

Table 7.12 Turbidity and pH Runoff Sample Locations		
Sample Location Number	Sample Location	Estimate of Site (%)
1	Downstream of project site (See WP-6)	
2	Downstream of staging area (See WP-2)	
3-13	At storm drain inlets (See WP-3, WP-4 & WP-5)	

0 sampling locations have been identified for the collection of run-on samples where the run-on has the potential to contribute to an exceedance of an NAL or a Receiving Water Monitoring Trigger. Table 7.13 identifies the run-on sample locations.

Table 7.13 Turbidity and pH Run-On Sample Locations		
Sample Location Number	Sample Location	Sample Location Latitude and Longitude (Decimal Degrees)

The project does not receive run-on with the potential to exceed NALs or Receiving Water Monitoring Triggers.

7.7.2.3 *Monitoring Preparation*

Turbidity and pH samples will be collected and analyzed by:

Contractor	<input checked="" type="checkbox"/> Yes	<input type="checkbox"/> No
Consultant	<input type="checkbox"/> Yes	<input checked="" type="checkbox"/> No
Laboratory	<input type="checkbox"/> Yes	<input checked="" type="checkbox"/> No

Samples on the project site will be collected by the following contractor sampling personnel:

Name/Telephone Number: Greg Herback / 775-690-8941

Alternate(s)/Telephone Number:

An adequate stock of monitoring supplies and equipment for monitoring turbidity and will be available on the project site prior to a sampling event. Monitoring supplies and equipment will be stored in a cool temperature environment that will not come into contact with rain or direct sunlight. Sampling personnel will be available to collect samples in accordance with the sampling schedule. Supplies maintained at the project site will include, but are not limited to, field meters, extra batteries; clean powder-free nitrile gloves, sample collection equipment, appropriate sample containers, paper towels, personal rain gear, and *Effluent Sampling Field Log Sheets* and CoC forms provided in CSMP Attachment 3 “Example Forms”.

The contractor will obtain and maintain the field testing instruments, as identified in Section 7.7.2.6, for analyzing samples in the field by contractor sampling personnel.

Samples on the project site will be collected by the following:

Company Name: Herback General Engineering

Street Address: 2531 Nowlin Road

City, State Zip: Minden, NV 89423

Telephone Number: 775-690-8941

Point of Contact:

Name of Sampler(s): Greg Herback, QSP

Name of Alternate(s):

The QSP or his/her designee will contact the lab 24 hours prior to a predicted rain event or for an unpredicted event, as soon as a rain event begins to ensure that adequate sample collection personnel, supplies for monitoring pH and turbidity are available and will be mobilized to collect samples on the project site in accordance with the sampling schedule.

7.7.2.4 *Field Parameters*

Samples shall be analyzed for the constituents indicated in the Table 7.14.

Table 7.14 Sample Collection and Analysis for Monitoring Turbidity and pH

Parameter	Test Method	Minimum Sample Volume ⁽¹⁾	Sample Collection Container Type	Detection Limit (minimum)
Turbidity	Field meter/probe with calibrated portable instrument	500 mL	Polypropylene or Glass (Do not collect in meter sample cells)	1 NTU
pH	Field meter/probe with calibrated portable instrument or calibrated pH test kit	100 mL	Polypropylene	0.2 pH units

Notes: ¹ Minimum sample volume recommended. Specific volume requirements will vary by instrument; check instrument manufacturer instructions.
L – Liter
mL – Milliliter
NTU – Nephelometric Turbidity Unit

7.7.2.5 Sample Collection

Samples of discharge shall be collected at the designated runoff and run-on sampling locations shown on the Site Maps in Appendix B. Run-on samples shall be collected within close proximity of the point of run-on to the project.

Only personnel trained in water quality sampling and field measurements working under the direction of the QSP shall collect samples.

Sample collection and handling requirements are described in Section 7.7.7.

7.7.2.6 Field Measurements

Samples collected for field analysis, collection, analysis and equipment calibration shall be in accordance with the field instrument manufacturer’s specifications.

Immediately following collection, samples for field analysis shall be tested in accordance with the field instrument manufacturer’s instructions and results recorded on the *Effluent Sampling Field Log Sheet*.

The field instrument(s) listed in Table 7.15 will be used to analyze the following constituents:

Table 7.15 Field Instruments

Field Instrument (Manufacturer and Model)	Constituent
pH Meter	pH
Turbidity Meter	Turbidity

The manufacturers' instructions are included in CSMP Attachment 4 "Field Meter Instructions". Field sampling staff shall review the instructions prior to each sampling event and follow the instructions in completing measurement of the samples.

- The instrument(s) shall be maintained in accordance with manufacturer's instructions.
- The instrument(s) shall be calibrated before each sampling and analysis event.
- Maintenance and calibration records shall be maintained with the SWPPP.

The QSP may authorize alternate equipment provided that the equipment meets the Construction General Permit's requirements and the manufacturers' instructions for calibration and use are added to CSMP Attachment 4 "Field Meter Instructions".

7.7.2.7 Data Evaluation and Reporting

Immediately upon completing the measurements for the sampling event, provide the *Effluent Sampling Field Log Sheets* to the QSP for evaluation.

Numeric Action Levels

Compliance with the NAL for pH and turbidity is based on a weighted daily average. Upon receiving the field log sheets, the QSP shall immediately calculate the weighted arithmetic average of the turbidity samples, and the weighted logarithmic average of the pH samples¹ to determine if the NALs, shown in the table below, have been exceeded.

Table 7.16 Numeric Action Levels

Parameter	Unit	Daily Average
pH	pH units	Lower NAL = 6.5 Upper NAL = 8.5
Turbidity	NTU	250 NTU

The QSP shall within 1 days of the sample collection submit copies of the completed *Effluent Sampling Field Log Sheets* to owner's representative.

In the event that the pH or turbidity NAL is exceeded, the QSP shall immediately notify owner's representative and investigate the cause of the exceedance and identify corrective actions.

Exceedances of NALs shall be electronically reported to the State Water Board by owner's representative through the SMARTs system within 10 days of the conclusion of the storm event. If requested by the Regional Board, a NAL Exceedance report will be submitted. The NAL Exceedance Report must contain the following information:

- Analytical method(s), method reporting unit(s), and MDL(s) of each parameter;
- Date, place, time of sampling, visual observation, and/or measurements, including precipitation; and

¹ Daily average pH values must be calculated through the logarithmic method. In order to calculate an average, you must: (1) Convert the pH measurements from logarithms to real numbers; (2) Take the average of the real numbers; and (3) Convert the average of the real numbers back to a logarithm.

- Description of the current BMPs associated with the sample that exceeded the NAL and the proposed corrective actions taken.

Receiving Water Monitoring Triggers

This project is subject to Receiving Water Monitoring Triggers for pH and turbidity (Table 7.17). Compliance with the Receiving Water Monitoring Triggers for pH and turbidity is based on a weighted daily average. The receiving water monitoring triggers for Risk Level 3 sites with direct discharges to surface waters are triggered when the daily average effluent pH values during any site phase when there is a high risk of pH discharge fall outside of the range of 6.0 and 9.0 pH units or when the daily average effluent turbidity exceeds 500 NTU.

Upon receiving the field log sheets, the QSP shall immediately calculate the weighted average of the turbidity samples, and the weighted logarithmic average of the pH samples. The SWRCB provides guidance and a spreadsheet for averaging pH in Issue 2013.1-pH Excel, located on this website, under the heading Construction General Permit – Technical Bulletins: http://www.waterboards.ca.gov/water_issues/programs/stormwater/gen_const_faqs.shtml

The weighted averages are then to be used to determine if the Receiving Water Monitoring Triggers, shown in the table below, have been exceeded.

Table 7.17 Receiving Water Monitoring Triggers

Parameter	Unit	Daily Average
pH	pH units	Lower Trigger = 6.0 Upper Trigger = 9.0
Turbidity	NTU	500 NTU

All pH and turbidity data shall be electronically reported to the State Water Board by owner’s representative through SMARTS within 10 days of the conclusion of each storm event.

In the event that the pH or turbidity Receiving Water Monitoring Trigger is exceeded, the QSP shall immediately notify owner’s representative.

Exceeding a Receiving Water Monitoring Trigger requires the implementation of receiving water monitoring described in Section 7.7.3 unless one of the follow two conditions existed:

- The exceedance occurred during a storm event equal to or larger than the compliance storm event (inches of rain in a 24 hour period) as demonstrated by the on-site rain gauge and confirmed with data from a nearby governmental rain gauge; or
- The exceedance was caused by run-on from a natural disaster (such as a forest fire).

Exceptions to the Receiving Water Monitoring Triggers will be documented in the SWPPP by the QSP and submitted to SMARTS when the data for the storm event is uploaded.

7.7.3 Sampling and Analysis Plan for pH, Turbidity, and SSC in Receiving Water

Following the exceedance of a Receiving Water Monitoring Trigger receiving water monitoring is required.

7.7.3.1 Sampling Schedule and Locations

A Receiving Water Monitoring Trigger Following the exceedance of the pH receiving water monitoring trigger, receiving water samples shall be collected for pH and any parameters required by the Regional Water Board.

Following the exceedance of the turbidity Receiving Water Monitoring Trigger, receiving water samples shall be collected for turbidity, SSC, and any parameters required by the Regional Water Board.

Receiving water samples will be collected. Sampling locations are based on the site discharge locations into the receiving water, location accessibility for sampling, and personnel safety. Planned sampling locations Site Maps in Appendix B and include the locations identified in Table 7.18.

13 sampling location(s) have been identified for the collection of receiving water samples.

Table 7.18 Receiving Water Sample Locations		
Upstream/Upgradient/Background <i>(This location(s) is a representative and accessible location located as close as possible and upstream from the runoff discharge point)</i>		
Sample location number(s)	Sample Location Description	Sample Location Latitude and Longitude
None		
Downstream/downgradient <i>(This location(s) is a representative and accessible location located as close as possible and downstream from the runoff discharge point)</i>		
Sample location number(s)	Sample Location	Sample Location Latitude and Longitude
1	Downstream of project site (See WP-6)	
2	Downstream of staging area (See WP-2)	
3-13	At storm drain inlets (See WP-3, WP-4 & WP-5)	

The receiving water locations are located on the project site. No special permissions are needed to access the site.

7.7.3.2 Monitoring Preparation

Receiving water samples will be collected by:

- Contractor Yes No
- Consultant Yes No
- Laboratory Yes No

Samples on the project site will be collected by the following contractor sampling personnel:

Name/Telephone Number: Greg Herback / 775-690-8941

Alternate(s)/Telephone Number:

An adequate stock of monitoring supplies and equipment for monitoring the receiving will be available on the project site prior to a sampling event. Monitoring supplies and equipment will be stored in a cool temperature environment that will not come into contact with rain or direct sunlight. Sampling personnel will be available to collect samples in accordance with the sampling schedule. Supplies maintained at the project site will include, but are not limited to, clean powder-free nitrile gloves, sample collection equipment, field meters, appropriate sample containers, paper towels, personal rain gear, and *Receiving Water Sampling Field Log Sheets* and CoC forms provided in CSMP Attachment 3 “Example Forms”.

Samples on the project site will be collected by the following:

Company Name: Herback General Engineering
 Street Address: 2531 Nowlin Road
 City, State, Zip: Minden, NV 89423
 Telephone Number: 775-690-8941
 Point of Contact:
 Name of Sampler(s): Greg Herback, QSP
 Name of Alternate(s):

The QSP or his/her designee will contact the lab 24 hours prior to a planned receiving water sampling event to ensure that adequate sample collection personnel, supplies for monitoring are available and will be mobilized to collect samples on the project site in accordance with the sampling schedule.

7.7.3.3 Sample Collection and Analysis

Receiving water samples shall be collected at the designated sampling locations shown on the Site Maps in Appendix B and as identified in Section 7.7.3.2.1.

Only personnel trained in water quality sampling under the direction of the QSP shall collect samples.

SSC grab samples for laboratory analysis shall be collected and preserved in accordance with the methods identified in the Table 7.19. Samples will be shipped to the laboratory identified below.

Table 7.19 Sample Collection, Preservation and Analysis for Monitoring Suspended Sediment Concentration (SSC)

Parameter	Test Method	Sample Preservation	Minimum Sample Volume ⁽¹⁾	Sample Bottle	Maximum Holding Time	Detection Limit (minimum)
Suspended Sediment Concentration (SSC)	ASTM D3977-97	Store at 4° C (39.2° F)	200 mL	Contact Laboratory	7 days	5 mg/L

Samples will be analyzed by:

Laboratory Name: WETLAB - Western Environmental Testing Laboratory
Street Address: 475 E. Greg St, Suite 119
City, State Zip: Sparks, NV 89431
Telephone Number: (775) 355-0202
Point of Contact:

Samples will be delivered to the laboratory by:

Driven by Contractor Yes No
Picked up by Laboratory Courier Yes No
Shipped Yes No

Samples for field parameters shall be analyzed for the constituents indicated in Section 7.7.2.4, "Sample Collection, and Analysis for Monitoring Turbidity and pH." Turbidity and pH samples shall be analyzed immediately.

Grab samples for parameters required by the Regional Water Board shall be collected and preserved in accordance with the methods identified Section 7.7.5.5. Samples will be shipped to the laboratory identified in Section 7.7.1.6.

Sample collection and handling requirements are described in Section 7.7.7.

7.7.3.4 Data Evaluation and Reporting

The QSP shall complete an evaluation of the receiving water quality sample analytical results.

Downgradient results shall be compared with the associated upgradient/background results and any associated construction runoff results. Should the downgradient sample show an increased level of the tested analyte relative to the upgradient/background sample, the QSP shall initiate an evaluation of the BMPs, site conditions, and surrounding influences shall be assessed to determine the probable cause for the increase in the receiving water.

As determined by the evaluation, appropriate BMPs shall be repaired or modified to mitigate discharges of non-visible pollutant concentrations. Any revisions to the BMPs shall be recorded as an amendment to the SWPPP.

Receiving water data shall be reported in the Annual Report.

7.7.4 Sampling and Analysis Plan for Non-Stormwater Discharges

This Sampling and Analysis Plan for non-stormwater discharges describes the sampling and analysis strategy and schedule for monitoring pollutants in authorized and unauthorized non-stormwater discharges from the project site in accordance with the requirements of the Construction General Permit.

Sampling of non-stormwater discharges will be conducted when an authorized or unauthorized non-stormwater discharge is observed discharging from the project site. In the event that

non-stormwater discharges run-on to the project site from offsite locations, and this run-on has the potential to contribute to a violation of a NAL, the run-on will also be sampled.

The following authorized non-stormwater discharges identified in Section 2.7, have the potential to be discharged from the project site.

- None

In addition to the above authorized stormwater discharges, some construction activities have the potential to result in an unplanned (unauthorized) non-stormwater discharge if BMPs fail. These activities include:

- Demolition
- Excavating
- Paving & Grinding Operation
- Vehicle and equipment fueling and batteries
- Washing out Concrete

7.7.4.1 Sampling Schedule

Samples of authorized or unauthorized non-stormwater discharges shall be collected when they are observed.

7.7.4.2 Sampling Locations

Samples shall be collected from the discharge point of the construction site where the non-stormwater discharge is running off the project site. Site discharge locations are shown on the Site Maps in SWPPP Appendix A and include the locations identified below.

0 sampling location(s) on the project site and the contractor’s yard have been identified where non-stormwater discharges may runoff from the project site. (Table 7.20)

Table 7.20 Non-stormwater Discharge Sample Locations		
Sample Location Number	Sample Location	Sample Location Latitude and Longitude (Decimal Degrees)
	Exact location to be determined by QSP	

0 sampling locations have been identified for the collection of non-stormwater discharges that run-on to the project site (Table 7.21).

Table 7.21 Non-stormwater Run-on Sample Locations		
Sample Location Number	Sample Location	Sample Location Latitude and Longitude (Decimal Degrees)

7.7.4.3 Monitoring Preparation

Non-stormwater discharge samples will be collected by:

- Contractor Yes No
- Consultant Yes No
- Laboratory Yes No

Samples on the project site will be collected by the following contractor sampling personnel:

Name/Telephone Number: Greg Herback / 775-690-8941

Alternate(s)/Telephone Number:

An adequate stock of monitoring supplies and equipment for monitoring non-stormwater discharges will be available on the project site. Monitoring supplies and equipment will be stored in a cool temperature environment that will not come into contact with rain or direct sunlight. Personnel trained in sampling will be available to collect samples in accordance with the sampling schedule. Supplies maintained at the project site will include, but are not limited to, clean powder-free nitrile gloves, sample collection equipment, field meters, coolers, appropriate number and volume of sample bottles, identification labels, re-sealable storage bags, paper towels, personal rain gear, ice, and *Effluent Sampling Field Log Sheets* and CoC forms provided in CSMP Attachment 3 “Example Forms”.

The contractor will obtain and maintain the field testing instruments, as identified in Section 7.7.2, for analyzing samples in the field by contractor sampling personnel.

Samples on the project site will be collected by the following:

Company Name: Herback General Engineering

Street Address: 2531 Nowlin Road

City, State Zip: Minden, NV 89423

Telephone Number: 775-690-8941

Point of Contact:

Name of Sampler(s): Greg Herback, QSP

Name of Alternate(s):

The QSP or his/her designee will contact the lab, 24 hours prior to a planned non-stormwater discharge or as soon as an unplanned non-stormwater discharge is observed to ensure that adequate sample collection personnel, supplies for non-stormwater discharge monitoring are available and will be mobilized to collect samples on the project site in accordance with the sampling schedule.

7.7.4.4 Analytical Constituents

All non-stormwater discharges that flow through a disturbed area shall, at minimum, be monitored for turbidity.

All non-stormwater discharges that flow through an area where they are exposed to pH altering materials shall be monitored for pH.

The QSP shall identify additional pollutants to be monitored for each non-stormwater discharge incident based on the source of the non-stormwater discharge. If the source of an unauthorized non-stormwater discharge is not known, monitoring for pH, turbidity, MBAS, TOC, and residual chlorine or chloramines is recommended to help identify the source of the discharge.

Non-stormwater discharge run-on shall be monitored, at minimum, for pH and turbidity. The QSP shall identify additional pollutants to be monitored for each non-stormwater discharge incident based on the source of the non-stormwater discharge. If the source of an unauthorized non-stormwater discharge is not known, monitoring for pH, turbidity, MBAS, TOC, and residual chlorine or chloramines is recommended to help identify the source of the discharge.

Table 7.22 lists the specific sources and types of potential non-visible pollutants on the project site and the water quality indicator constituent(s) for that pollutant.

Table 7.22 Potential Non-Stormwater Discharge Pollutants and Water Quality Indicator Constituents

Pollutant Source	Pollutant	Water Quality Indicator Constituent
Disturbed Soil / Stockpile Areas	Sediment	Turbidity
Disturbed Soil / Stockpile Areas	pH	pH

Sampling and analysis of runoff for pH and turbidity is required for this project. This Sampling and Analysis Plan describes the strategy for monitoring turbidity and pH levels of storm water runoff discharges from the project site and run-on that may contribute to an exceedance of a Numeric Action Level (NAL).

Specifically, sampling and analysis for pH and turbidity (per the NAL exceedance levels indicated in the Construction General Permit) is required for any runoff that is not captured by

the contractor's dewatering system and discharged via the City permit to the City's sanitary sewer system. Sampling and analysis of the aforementioned diverted runoff and site dewatering shall be per the City permit. Samples for turbidity will be collected from all drainage areas with disturbed soil areas and samples for pH will be collected from all drainage areas with a high risk of pH discharge.

7.7.4.5 Sample Collection

Samples shall be collected at the discharge locations where the non-stormwater discharge is leaving the project site. Potential discharge locations are shown on the Site Maps in Appendix B and identified in Section 7.7.4.2.

Grab samples shall be collected and preserved in accordance with the methods identified in Table 7.23. Only personnel trained in water quality sampling under the direction of the QSP shall collect samples.

Sample collection and handling requirements are described in Section 7.7.7.

7.7.4.6 Sample Analysis

Samples shall be analyzed using the analytical methods identified in Table 7.23.

7.7.4.7 Data Evaluation and Reporting

The QSP shall complete an evaluation of the water quality sample analytical results.

Turbidity and pH results shall be evaluated for compliance with NALs and NELs as identified in Section 7.7.2.7.

Runoff results shall also be evaluated for the constituents suspected in the non-stormwater discharge. Should the runoff sample indicate the discharge of a pollutant which cannot be explained by run-on results, the BMPs, site conditions, and surrounding influences shall be assessed to determine the probable cause for the increase.

As determined by the site and data evaluation, appropriate BMPs shall be repaired or modified to mitigate discharges of non-visible pollutant concentrations. Any revisions to the BMPs shall be recorded as an amendment to the SWPPP.

Non-storm water discharge results shall be submitted with the Annual Report.

The General Permit prohibits the non-storm water discharges that contain hazardous substances equal to or in excess of reportable quantities established in 40 C.F.R. §§ 117.3 and 302.4. The results of any non-stormwater discharge results that indicate the presence of a hazardous substance in excess of established reportable quantities shall be immediately reported to the Regional Water Board.

Table 7.23 Sample Collection, Preservation and Analysis for Monitoring Pollutants in Non-Stormwater Discharges

Constituent	Analytical Method	Minimum Sample Volume	Sample Containers	Sample Preservation	Reporting Limit	Maximum Holding Time
Methyl Methacrylate (MMA)	EPA 625 2 L	1000 ml	glass	Store at 4° C	10 ug/L	14 days
Chlorine	SM 4500	500 mL	Polypropylene	Do not expose to light	0.1 mg/L	Immediate
CODs	EPA410.4	20 ml	250 ml glass	Store at 4° C, H2So4	10.0 mg/L	28 days
Nitrate	EPA300.0	500 mL	PE or glass	Store at 4° C	0.1 mg/L	14 days
Nitrogen	EPA351.3	100 mL	Glass	Store at 4° C	0.1 mg/L	28 days
VOCs	EPA 8260B	3 x 40 ml	Amber Glass	Store at 4° C, HCL to pH<2	1 ug/L	14 days
TOCs	EPA415.1 (TOC)	150 ml	250 ml glass	Store at 4° C, H2So4	1 mg/L	28 days
Herbicide	EPA 8151A	1000 ml	1 L amber glass	Store at 4° C	1 ug/L	7 days
Phenols	EPA 420.1 (Phenol)	500 ml	500 ml amber glass	Store at 4° C, H2So4	0.1 mg/L	28 days
Sulfate	EPA300.0	250 ml	Polypropylene	Store at 4° C	0.1 mg/L	28 days
Metals	EPA200.8	250 ml	Polypropylene	Store at 4° C, HNO3 to pH<2	0.2 mg/L	6 months
Notes:						

7.7.5 Sampling and Analysis Plan for Other Pollutants Required by the Regional Water Board

The Regional Water Board has not specified monitoring for additional pollutants.

This Sampling and Analysis Plan describes the sampling and analysis strategy and schedule for monitoring additional pollutants as specified in the communication from the Regional Water Board. This communication is included in CSMP Attachment 5 “Supplemental Information”.

7.7.5.1 Sampling Schedule

Runoff samples shall be collected for pollutants from all qualifying rain events that result in a discharge from the project site. At minimum, samples will be collected from each site discharge location. A minimum of 3 samples will be collected per day of discharge from a qualifying event. Samples should be representative of the total discharge from the location each day of discharge during the qualifying event. Typically representative samples will be spaced in time throughout the daily discharge event.

Stored or collected water from a qualifying storm event will be sampled when discharged. Stored or collected water from a qualifying event may be sampled at the point it is release from the storage or containment area or at the site discharge location.

7.7.5.2 Sampling Locations

Sampling locations are based on the site discharge locations; accessibility for sampling; and personnel safety. Planned sample locations are shown on the Site Maps in Appendix B and include the locations identified below.

0 sampling location(s) on the project site and the contractor’s yard have been identified for the collection of runoff samples (Table 7.24).

Table 7.24 Runoff Sample Locations for Other Pollutants Required by the Regional Water Board		
Sample Location Number	Sample Location	Sample Location Latitude and Longitude (Decimal Degrees)

7.7.5.3 Monitoring Preparation

Samples will be collected by:

- Contractor Yes No
- Consultant Yes No
- Laboratory Yes No

Samples on the project site will be collected by the following contractor sampling personnel:

Name/Telephone Number:

Alternate(s)/Telephone Number:

An adequate stock of monitoring supplies and equipment for monitoring Pollutants will be available on the project site prior to a sampling event. Monitoring supplies and equipment will be stored in a cool temperature environment that will not come into contact with rain or direct sunlight. Sampling personnel will be available to collect samples in accordance with the sampling schedule. Supplies maintained at the project site will include, but are not limited to, field meters, and backup; extra batteries; clean powder-free nitrile gloves, sample collection equipment, appropriate sample containers, paper towels, personal rain gear, and *Effluent Sampling Field Log Sheets* and CoC forms provided in CSMP Attachment 3 “Example Forms”.

The contractor will obtain and maintain the field testing instruments, as identified in Section 7.7.2, for analyzing samples in the field by contractor sampling personnel.

Samples on the project site will be collected by the following:

Company Name: Herback General Engineering

Street Address: 2531 Nowlin Road

City, State, Zip: Minden, NV 89423

Telephone Number: 775-690-8941

Point of Contact:

Name of Sampler(s): Greg Herback, QSP

Name of Alternate(s):

The QSP or his/her designee will contact the lab 24 hours prior to a predicted rain event or for an unpredicted event, as soon as a rain event begins to ensure that adequate sample collection personnel, supplies for monitoring Pollutants are available and will be mobilized to collect samples on the project site in accordance with the sampling schedule.

7.7.5.4 *Sample Collection*

Runoff samples of discharge shall be collected at the designated sampling locations as identified above and shown on the Site Maps in Appendix B and as identified in Section 7.7.5.2.

Grab samples shall be collected and preserved in accordance with the methods identified in Table 7.25. Only personnel trained in water quality sampling under the direction of the QSP shall collect samples.

Sample collection and handling requirements are described in Section 7.7.7.

7.7.5.5 *Sample Analysis*

Samples shall be analyzed using the analytical methods identified in Table 7.25.

Table 7.25 Sample Collection, Preservation and Analysis for Monitoring Regional Board Required Pollutants

Constituent	Analytical Method	Minimum Sample Volume	Sample Bottle	Sample Preservation	Reporting Limit	Maximum Holding Time
Notes:						

7.7.5.6 *Data Evaluation and Reporting*

7.7.6 *Training of Sampling Personnel*

Sampling personnel shall be trained to collect, maintain, and ship samples in accordance with the Surface Water Ambient Monitoring program (SWAMP) 2008 Quality Assurance Program Plan (QAPrP). Training records of designated contractor sampling personnel are provided in Appendix K.

The stormwater sampler(s) and alternate(s) have received the following stormwater sampling training:

Name	Training
Greg Herback	QSP Training Course and Certified QSP

The stormwater sampler(s) and alternates have the following stormwater sampling experience:

Name	Experience
Greg Herback	QSP Training Course and Certified QSP

7.7.7 *Sample Collection and Handling*

7.7.7.1 *Sample Collection*

Samples shall be collected at the designated sampling locations shown on the Site Maps and listed in the preceding sections. Samples shall be collected, maintained and shipped in accordance with the SWAMP 2008 Quality Assurance Program Plan (QAPrP).

Grab samples shall be collected and preserved in accordance with the methods identified in preceding sections.

To maintain sample integrity and prevent cross-contamination, sample collection personnel shall follow the protocols below.

- Collect samples (for laboratory analysis) only in analytical laboratory-provided sample containers;
- Wear clean, powder-free nitrile gloves when collecting samples;
- Change gloves whenever something not known to be clean has been touched;
- Change gloves between sites;
- Decontaminate all equipment (e.g. bucket, tubing) prior to sample collection using a trisodium phosphate water wash, distilled water rinse, and final rinse with distilled water. (Dispose of wash and rinse water appropriately, i.e., do not discharge to storm drain or receiving water). Do not decontaminate laboratory provided sample containers;
- Do not smoke during sampling events;
- Never sample near a running vehicle;

- Do not park vehicles in the immediate sample collection area (even non-running vehicles);
- Do not eat or drink during sample collection; and
- Do not breathe, sneeze, or cough in the direction of an open sample container.

The most important aspect of grab sampling is to collect a sample that represents the entire runoff stream. Typically, samples are collected by dipping the collection container in the runoff flow paths and streams as noted below.

- For small streams and flow paths, simply dip the bottle facing upstream until full.
- For larger stream that can be safely accessed, collect a sample in the middle of the flow stream by directly dipping the mouth of the bottle. Once again making sure that the opening of the bottle is facing upstream as to avoid any contamination by the sampler.
- For larger streams that cannot be safely waded, pole-samplers may be needed to safely access the representative flow.
- Avoid collecting samples from ponded, sluggish or stagnant water.
- Avoid collecting samples directly downstream from a bridge as the samples can be affected by the bridge structure or runoff from the road surface.

Note, that depending upon the specific analytical test, some containers may contain preservatives. These containers should **never** be dipped into the stream, but filled indirectly from the collection container.

SSC samples should be taken as a normal grab sample, where the bottle is submerged facing upstream and filled. SSC samples need to be collected in a separate bottle because the analysis requires the entire volume of the bottle. Do not collect in a larger container and partition into the laboratory sample container.

7.7.7.2 *Sample Handling*

Turbidity and pH measurements must be conducted immediately. Do not store turbidity or pH samples for later measurement.

Samples for laboratory analysis must be handled as follows. Immediately following sample collection:

- Cap sample containers;
- Complete sample container labels;
- Sealed containers in a re-sealable storage bag;
- Place sample containers into an ice-chilled cooler;
- Document sample information on the *Effluent Sampling Field Log Sheet*; and
- Complete the CoC.

All samples for laboratory analysis must be maintained between 0-6 degrees Celsius during delivery to the laboratory. Samples must be kept on ice, or refrigerated, from sample collection through delivery to the laboratory. Place samples to be shipped inside coolers with ice. Make sure the sample bottles are well packaged to prevent breakage and secure cooler lids with packaging tape.

Ship samples that will be laboratory analyzed to the analytical laboratory right away. Hold times are measured from the time the sample is collected to the time the sample is analyzed. The

General Permit requires that samples be received by the analytical laboratory within 48 hours of the physical sampling (unless required sooner by the analytical laboratory).

7.7.7.3 Sample Documentation Procedures

All original data documented on sample bottle identification labels, *Effluent Sampling Field Log Sheet*, and CoCs shall be recorded using waterproof ink. These shall be considered accountable documents. If an error is made on an accountable document, the individual shall make corrections by lining through the error and entering the correct information. The erroneous information shall not be obliterated. All corrections shall be initialed and dated.

Duplicate samples shall be identified consistent with the numbering system for other samples to prevent the laboratory from identifying duplicate samples. Duplicate samples shall be identified in the *Effluent Sampling Field Log Sheet*.

Sample documentation procedures include the following:

Sample Bottle Identification Labels: Sampling personnel shall attach an identification label to each sample bottle. Sample identification shall uniquely identify each sample location.

Field Log Sheets: Sampling personnel shall complete the *Effluent Sampling Field Log Sheet* and *Receiving Water Sampling Field Log Sheet* for each sampling event, as appropriate.

Chain of Custody: Sampling personnel shall complete the CoC for each sampling event for which samples are collected for laboratory analysis. The sampler will sign the CoC when the sample(s) is turned over to the testing laboratory or courier.

7.8 Active Treatment System Monitoring

An Active Treatment System (ATS) will be deployed on the site?

Yes No

This project does not require a project specific Sampling and Analysis Plan for an ATS because deployment of an ATS is not planned.

The project specific Sampling and Analysis Plan for the ATS is provided in the ATS Monitoring and Sampling Plan (MSRP).

7.9 Bioassessment Monitoring

This project is Risk Level 3 Yes No

This project will disturb more than 30 acres Yes No

This project directly discharges runoff to a freshwater wadeable stream (or streams) that is either: Yes No

a) Listed by the State Water Board or EPA as impaired due to sediment or is tributary to any downstream waterbody that is listed for sediment impairments

or

b) Has the beneficial uses of SPAWN and COLD and
MIGRATORY



This project is not subject to bioassessment monitoring because it does not meet both of the permit specified trigger requirements.

This project is subject to bioassessment monitoring requirements. The bioassessment monitoring program is specified in:

This project is subject to bioassessment monitoring requirements. The Regional Water Board has approved a bioassessment sampling exception for the project. Documentation of the sampling exception approval and payment to the SWAMP fund is included in CSMP Attachment 5 “Supplemental Information”.

7.10 Watershed Monitoring Option

This project is not participating in a watershed monitoring option.

7.11 Quality Assurance and Quality Control

An effective Quality Assurance and Quality Control (QA/QC) plan shall be implemented as part of the CSMP to ensure that analytical data can be used with confidence. QA/QC procedures to be initiated include the following:

- Field logs;
- Clean sampling techniques;
- CoCs;
- QA/QC Samples; and
- Data verification.

Each of these procedures is discussed in more detail in the following sections.

7.11.1 Field Logs

The purpose of field logs is to record sampling information and field observations during monitoring that may explain any uncharacteristic analytical results. Sampling information to be included in the field log include the date and time of water quality sample collection, sampling personnel, sample container identification numbers, and types of samples that were collected. Field observations should be noted in the field log for any abnormalities at the sampling location (color, odor, BMPs, etc.). Field measurements for pH and turbidity should also be recorded in the field log. A Visual Inspection Field Log, an Effluent Sampling Field Log Sheet, and Receiving Water Sampling Field Log Sheet are included in CSMP Attachment 3 “Example Forms”.

7.11.2 Clean Sampling Techniques

Clean sampling techniques involve the use of certified clean containers for sample collection and clean powder-free nitrile gloves during sample collection and handling. As discussed in Section 7.7.7, adoption of a clean sampling approach will minimize the chance of field contamination and questionable data results.

7.11.3 Chain of Custody

The sample CoC is an important documentation step that tracks samples from collection through analysis to ensure the validity of the sample. Sample CoC procedures include the following:

- Proper labeling of samples;
- Use of CoC forms for all samples; and
- Prompt sample delivery to the analytical laboratory.

Analytical laboratories usually provide CoC forms to be filled out for sample containers. An example CoC is included in CSMP Attachment 3 “Example Forms”.

7.11.4 QA/QC Samples

QA/QC samples provide an indication of the accuracy and precision of the sample collection; sample handling; field measurements; and analytical laboratory methods. The following types of QA/QC will be conducted for this project:

- Field Duplicates at a frequency of 5 percent or 1 duplicate minimum per sampling event (Required for all sampling plans with field measurements or laboratory analysis)
- Equipment Blanks at a frequency of frequency required by method (Only needed if equipment used to collect samples could add the pollutants to sample)
- Field Blanks at a frequency of frequency required by method (Only required if sampling method calls for field blanks)
- Travel Blanks at a frequency of frequency required by method (Required for sampling plans that include VOC laboratory analysis)

7.11.4.1 Field Duplicates

Field duplicates provide verification of laboratory or field analysis and sample collection. Duplicate samples shall be collected, handled, and analyzed using the same protocols as primary samples. The sample location where field duplicates are collected shall be randomly selected from the discharge locations. Duplicate samples shall be collected immediately after the primary sample has been collected. Duplicate samples must be collected in the same manner and as close in time as possible to the original sample. Duplicate samples shall not influence any evaluations or conclusion.

7.11.4.2 Equipment Blanks

Equipment blanks provide verification that equipment has not introduced a pollutant into the sample. Equipment blanks are typically collected when:

- New equipment is used;
- Equipment that has been cleaned after use at a contaminated site;
- Equipment that is not dedicated for surface water sampling is used; or
- Whenever a new lot of filters is used when sampling metals.

7.11.4.3 Field Blanks

Field blanks assess potential sample contamination levels that occur during field sampling activities. De-ionized water field blanks are taken to the field, transferred to the appropriate

container, and treated the same as the corresponding sample type during the course of a sampling event.

7.11.4.4 *Travel Blanks*

Travel blanks assess the potential for cross-contamination of volatile constituents between sample containers during shipment from the field to the laboratory. De-ionized water blanks are taken along for the trip and held unopened in the same cooler with the VOC samples.

7.11.5 **Data Verification**

After results are received from the analytical laboratory, the QSP shall verify the data to ensure that it is complete, accurate, and the appropriate QA/QC requirements were met. Data must be verified as soon as the data reports are received. Data verification shall include:

- Check the CoC and laboratory reports.
Make sure all requested analyses were performed and all samples are accounted for in the reports.
- Check laboratory reports to make sure hold times were met and that the reporting levels meet or are lower than the reporting levels agreed to in the contract.
- Check data for outlier values and follow up with the laboratory.
Occasionally typographical errors, unit reporting errors, or incomplete results are reported and should be easily detected. These errors need to be identified, clarified, and corrected quickly by the laboratory. The QSP should especially note data that is an order of magnitude or more different than similar locations, or is inconsistent with previous data from the same location.
- Check laboratory QA/QC results.
EPA establishes QA/QC checks and acceptable criteria for laboratory analyses. These data are typically reported along with the sample results. The QSP shall evaluate the reported QA/QC data to check for contamination (method, field, and equipment blanks), precision (laboratory matrix spike duplicates), and accuracy (matrix spikes and laboratory control samples). When QA/QC checks are outside acceptable ranges, the laboratory must flag the data, and usually provides an explanation of the potential impact to the sample results.
- Check the data set for outlier values and, accordingly, confirm results and re-analyze samples where appropriate.
Sample re-analysis should only be undertaken when it appears that some part of the QA/QC resulted in a value out of the accepted range. Sample results may not be discounted unless the analytical laboratory identifies the required QA/QC criteria were not met and confirms this in writing.

Field data including inspections and observations must be verified as soon as the field logs are received, typically at the end of the sampling event. Field data verification shall include:

- Check field logs to make sure all required measurements were completed and appropriately documented;
- Check reported values that appear out of the typical range or inconsistent; Follow-up immediately to identify potential reporting or equipment problems, if appropriate, recalibrate equipment after sampling;

- Verify equipment calibrations;
- Review observations noted on the field logs; and
- Review notations of any errors and actions taken to correct the equipment or recording errors.

7.12 Records Retention

All records of stormwater monitoring information and copies of reports (including Annual Reports) must be retained for a period of at least three years from date of submittal or longer if required by the Regional Water Board.

Results of visual monitoring, field measurements, and laboratory analyses must be kept in the SWPPP along with CoCs, and other documentation related to the monitoring.

Records are to be kept onsite while construction is ongoing. Records to be retained include:

- The date, place, and time of inspections, sampling, visual observations, and/or measurements, including precipitation;
- The individual(s) who performed the inspections, sampling, visual observation, and/or field measurements;
- The date and approximate time of field measurements and laboratory analyses;
- The individual(s) who performed the laboratory analyses;
- A summary of all analytical results, the method detection limits and reporting limits, and the analytical techniques or methods used;
- Rain gauge readings from site inspections;
- QA/QC records and results;
- Calibration records;
- Visual observation and sample collection exemption records;
- The records of any corrective actions and follow-up activities that resulted from analytical results, visual observations, or inspections.

CSMP Attachment 1: Weather Reports

CSMP Attachment 2: Monitoring Records

CSMP Attachment 3: Example Forms

Rain Gauge Log Sheet

Construction Site Name:

WDID #:

Date (mm/dd/yy)	Time (24-hr)	Initials	Rainfall Depth (Inches)	Notes:

**Risk Level 1, 2, 3
Visual Inspection Field Log Sheet**

Date and Time of Inspection:	Report Date:
------------------------------	--------------

Inspection Type:	<input type="checkbox"/> Weekly	<input type="checkbox"/> Before predicted rain	<input type="checkbox"/> During rain event	<input type="checkbox"/> Following qualifying rain event	<input type="checkbox"/> Contained stormwater release	<input type="checkbox"/> Quarterly non-stormwater
------------------	---------------------------------	--	--	--	---	---

Site Information

Construction Site Name:

Construction stage and completed activities:	Approximate area of exposed site:
--	-----------------------------------

Weather and Observations

Date Rain Predicted to Occur:	Predicted % chance of rain:
-------------------------------	-----------------------------

Estimate storm beginning: <hr style="width:100%; border: none; border-top: 1px solid black; margin: 5px 0;"/> (date and time)	Estimate storm duration: <hr style="width:100%; border: none; border-top: 1px solid black; margin: 5px 0;"/> (hours)	Estimate time since last storm: <hr style="width:100%; border: none; border-top: 1px solid black; margin: 5px 0;"/> (days or hours)	Rain gauge reading: <hr style="width:100%; border: none; border-top: 1px solid black; margin: 5px 0;"/> (inches)
---	--	---	--

Observations: If yes identify location

Odors	Yes <input type="checkbox"/> No <input type="checkbox"/>
Floating material	Yes <input type="checkbox"/> No <input type="checkbox"/>
Suspended Material	Yes <input type="checkbox"/> No <input type="checkbox"/>
Sheen	Yes <input type="checkbox"/> No <input type="checkbox"/>
Discolorations	Yes <input type="checkbox"/> No <input type="checkbox"/>
Turbidity	Yes <input type="checkbox"/> No <input type="checkbox"/>

Site Inspections

Outfalls or BMPs Evaluated	Deficiencies Noted
(add additional sheets or attached detailed BMP Inspection Checklists)	

Photos Taken:	Yes <input type="checkbox"/> No <input type="checkbox"/>	Photo Reference IDs:
---------------	--	----------------------

Corrective Actions Identified (note if SWPPP/REAP change is needed)

Inspector Information

Inspector Name:	Inspector Title:
-----------------	------------------

Signature:	Date:
------------	-------

**Risk Level 2
Effluent Sampling Field Log Sheets**

Construction Site Name:	Date:	Time Start:
-------------------------	-------	-------------

Sampler:

Sampling Event Type:	<input type="checkbox"/> Stormwater	<input type="checkbox"/> Non-stormwater	<input type="checkbox"/> Non-visible pollutant
----------------------	-------------------------------------	---	--

Field Meter Calibration

pH Meter ID No./Desc.:	Turbidity Meter ID No./Desc.:
Calibration Date/Time:	Calibration Date/Time:

Field pH and Turbidity Measurements

Discharge Location Description	pH	Turbidity	Time

Grab Samples Collected

Discharge Location Description	Sample Type	Time

Additional Sampling Notes:

Time End:

NAL Exceedance Evaluation Summary Report		Page ___ of ___
Project Name		
Project WDID		
Project Location		
Date of Exceedance		
Type of Exceedance	NAL Daily Average <input type="checkbox"/> pH <input type="checkbox"/> Turbidity <input type="checkbox"/> Other (specify) _____	
Measurement or Analytical Method	<input type="checkbox"/> Field meter (Sensitivity: _____) <input type="checkbox"/> Lab method (specify) _____ (Reporting Limit: _____) (MDL: _____)	
Calculated Daily Average	<input type="checkbox"/> pH _____ pH units <input type="checkbox"/> Turbidity _____ NTU	
Rain Gauge Measurement	_____ inches	
Compliance Storm Event	_____ inches (5-year, 24-hour event)	
Visual Observations on Day of Exceedance		

<p>Description of BMPs in Place at Time of Event</p>	
<p>Initial Assessment of Cause</p>	
<p>Corrective Actions Taken (deployed after exceedance)</p>	
<p>Additional Corrective Actions Proposed</p>	
<p>Report Completed By</p>	<p>_____</p> <p>(Print Name, Title)</p>
<p>Signature</p>	<p>_____</p>

CHAIN-OF-CUSTODY

DATE:

Lab ID:

DESTINATION LAB: ATTN: ADDRESS: Office Phone: Cell Phone:							REQUESTED ANALYSIS		Notes:				
							SAMPLED BY:						
							Contact:						
Project Name													
Client Sample ID	Sample Date	Sample Time	Sample Matrix	Container									
				#	Type	Pres.							
SENDER COMMENTS:							RELINQUISHED BY						
							Signature:						
							Print:						
							Company:						
LABORATORY COMMENTS:							Date:					TIME:	
							RECEIVED BY						
							Signature:						
							Print:						
							Company:						
							Date:					TIME:	

CSMP Attachment 4: Field Meter Instructions

Instruction Manual

HI 98703 Portable Turbidimeter



MEASUREMENT PROCEDURE

When taking any turbidity measurements several basic rules should be followed:

- Use always cuvetts without scratches or cracks because they can cause inaccurate readings.
- Cap always the cuvetts to avoid spillage of the sample into the instrument.
- Close always the lid of the instrument during measurement.
- Keep the lid of the instrument closed when it is not used to prevent dust or dirt entering.
- Put always the instrument on a flat, rugged surface when taking measurements.
- Do not operate in direct sunlight.
- Do not use too much oil to prevent contamination of the optical system.

To take turbidity measurements, follow the next steps:

- Turn the instrument ON by pressing ON/OFF.
When dashes are displayed on the LCD, the instrument is ready. On the secondary LCD the current time appears, if selected in SETUP menu.
- Fill a clean, dry cuvette with 10 mL of sample up to the mark, taking care to handle the cuvette by the top.
- Replace the cap.
- Wipe the cuvette thoroughly with a lint-free cloth to remove any fingerprints, dirt or water spots.
- Apply silicone oil on the cuvette and wipe with a lint-free cloth to obtain an even film over the entire surface of the cuvette.

Note: It is very important to oil the cuvette, especially for low turbidity values (< 1 NTU) to hide the glass imperfections that can influence the reading.

- Place the cuvette into the instrument. Align the mark from the cuvette with the sign on the instrument case and close the lid.

Note: If you have a cuvette with orientation mark, place the cuvette into the instrument with the orientation mark aligned with the sign on the instrument top.

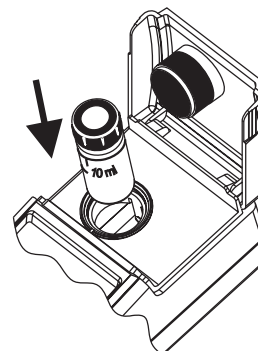
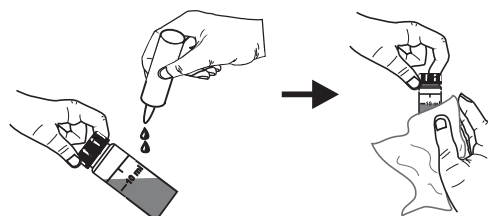
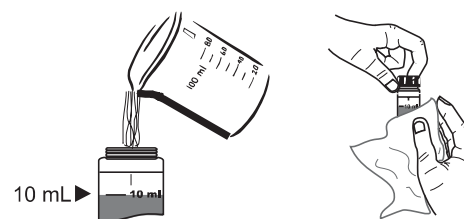
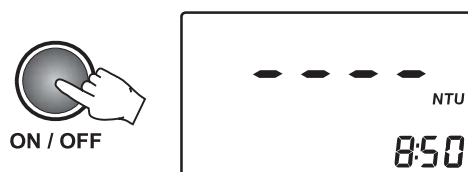

NORMAL MEASUREMENT

This type of measurement can be used for regular measurements, when the sample is stable and normal accuracy is required. In normal measurement mode, the lamp is ON for a minimum period of time (about 7 seconds), saving the battery life. Normal measurement takes about 10 seconds. If normal measurement is selected, the "AVG" tag will not be displayed.

- Press READ ► to start the measurement.
The display will show blinking dashes and the icons for cuvet, detectors and lamp will appear during measurement.

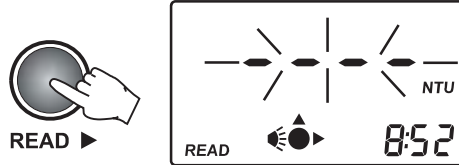

At the end of the measurement, the instrument directly displays turbidity in NTU.



CONTINUOUS MEASUREMENT

This measurement mode can be used when many measurements have to be taken in a short period of time. The feature is also useful to evaluate a very fast settling sample. This measurement mode is recommended for indexing cuvetts. After the first reading is taken, the lid opening will not generate any errors.

The first value is displayed after about 10 seconds and then a new reading is displayed each second. In order to make a continuous measurement keep READ ► pressed until the desired number of measurements are taken. The display will show blinking dashes and the icons for cuvet, detectors and lamp will appear. When a new value is displayed, the cuvet icon and the measurement unit will briefly blink.

The last value remains on the display after the READ ► is released.

AVERAGED MEASUREMENT

Select this measurement mode when samples that cause unstable readings are analyzed. By averaging several readings, the random noise generated by the sample is reduced and accurate measurements can be taken.

This mode can also be selected when high accuracy measurements are desired. In the average mode 10 measurements are averaged in a short period of time (about 20 seconds). The initial value is displayed after 10 seconds and the display is updated every second with an intermediate value.

- To select the averaged measurement mode press AVG ▼.
When this mode is selected, the AVG icon will be displayed on the LCD.

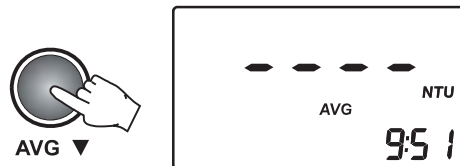

- Press READ ► to start the average reading mode. The display will show blinking dashes and the icons for cuvet, detectors and lamp will appear during measurement. When a new partial value is displayed, the cuvet icon and the measurement unit will blink shortly. When the measurement is ended, the final averaged result is displayed directly in NTU.

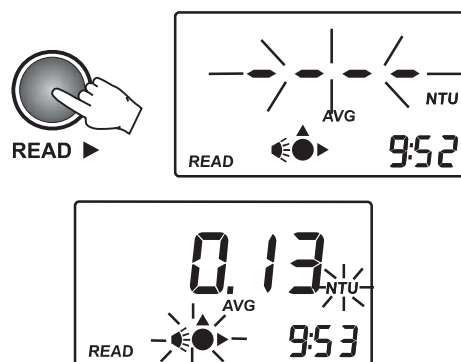

RANGE AND UNITS

HI 98703 automatically selects the correct range to display the results with the highest accuracy. If the measured value is higher than 1000 NTU (over range), the display will show the maximum value blinking.

The instrument has an EPA compliance reading mode. If this feature is activated in SETUP, “EPA” tag will appear on the LCD and the readings will be rounded to meet EPA reporting requirements, as shown in the table:

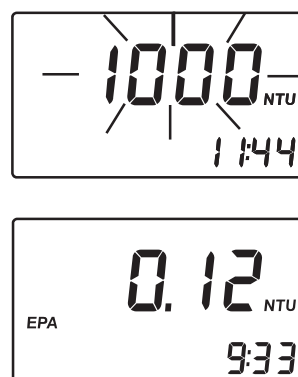

NTU	Round to Nearest
0.0-1.0	0.05
1-10	0.1
10-40	1
40-100	5
100-400	10
400-1000	50
> 1000	100

CALIBRATION PROCEDURE

HI 98703 has a powerful calibration function that compensates for lamp aging or changing. The calibration can be done using the supplied calibration solutions or user prepared standards.

HI 98703 turbidimeter is supplied with 4 AMCO standards: <0.1 NTU, 15 NTU, 100 NTU and 750 NTU. The Hanna standards are specially designed for this instrument. The turbidity standards have a shelf life and should not be used after the expiration date.

Alternatively, formazin standards can be used. It is recommended that the prepared calibration solutions to be close to the default calibration points.

The first point should be near 0 NTU. The second point can be chosen between 10 and 20 NTU, the third point between 50 and 150 NTU and the fourth point between 600 and 900 NTU.

FORMAZIN PREPARATION

In order to prepare formazin 4000 NTU stock solution, follow the next procedure:

Solution I Dissolve 1.000 grams of hydrazine sulfate, $(\text{NH}_2)_2 \text{H}_2\text{SO}_4$, in distilled, deionized water and dilute to 100 mL in a volumetric flask.

Warning: Handle hydrazine sulfate with care because it is a carcinogen reagent. Avoid inhalation, ingestion, or skin contact. Formazin solution can also contain some hydrazine traces.

Solution II Dissolve 10.000 grams of hexamethylenetetramine, $(\text{CH}_2)_6\text{N}_4$, in distilled, deionized water and dilute to 100 mL in a volumetric flask.

Stock solution Mix 10 mL Solution I and 10 mL Solution II in a flask. Let the stock solution stays 48 hours at $25 \pm 3^\circ\text{C}$ ($77 \pm 5^\circ\text{F}$). This will result in a 4000 NTU formazin suspension. It is very important for the formation of the formazin polymer to maintain the same temperature.

The stock solution (4000 NTU) can be stored up to one year in proper conditions. Store formazin in amber glass bottle or any UV-light blocking bottle.

To obtain a high quality formazin always use pure reagents and high-purity water.

To prepare the calibration standards, dilute the stock solution with the same high-purity water you used for the preparation of the stock solution.

The diluted formazin solutions are not stable. They should be used immediately after preparation and discard immediately after use.

If the prepared formazin is used, enter the actual standard value by pressing UP or DOWN key to edit the value of the second, third or fourth calibration point.

CALIBRATION

For best results, the measurement techniques must be followed during calibration. If formazin standards are used, mix the cuvetts gently for about 1 minute and then allow the standard to settle for one more minute before calibration.

Calibration can be performed in two, three or four points. It is possible to interrupt calibration procedure at any time by pressing CAL or ON/OFF.

TWO-POINT CALIBRATION

- Turn the instrument on by pressing ON/OFF. When the LCD displays dashes, the instrument is ready.
- Enter calibration mode by pressing CAL. The display will show "CAL P.1" and no suggested value. This first point is used to check the optical system.
- Place the <math><0.1</math> NTU standard cuvet into the holder and ensure that the cuvet mark is aligned with the sign on the instrument top.
- Close the lid and press READ ►. The display will show blinking dashes and the icons for cuvet, detectors and lamp will appear during measurement. Alternatively, press LOG/CFM to skip the first point.
- The second calibration point (15.0 NTU) is then displayed on the primary LCD, "CAL P.2" on the secondary LCD, and "READ" tag will blink.
- If the prepared formazin is used, edit the displayed value by pressing UP or DOWN keys until the display shows the correct value.
- Remove the first standard cuvet and place the 15.0 NTU standard cuvet (or the prepared one) into the holder and ensure that the cuvet mark is aligned with the sign on the instrument top.
- Close the lid and press READ ►. The display will show blinking dashes and the icons for cuvet, detectors and lamp will appear during measurement.

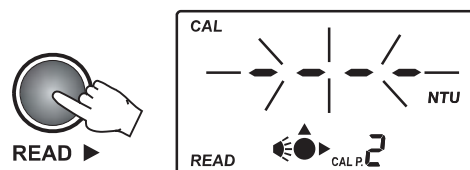
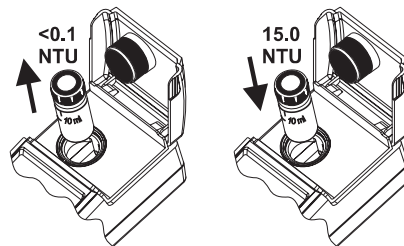
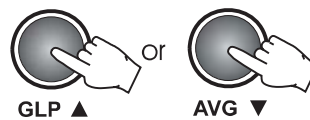
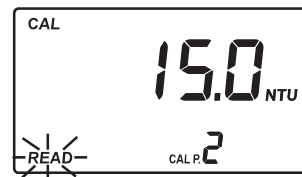
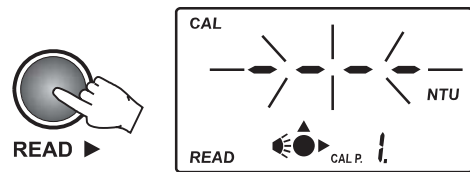
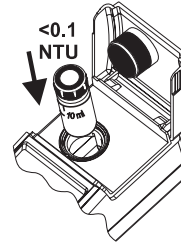
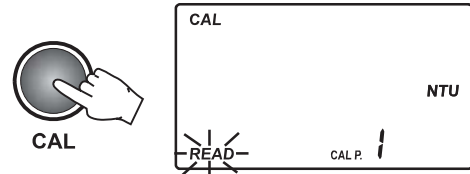
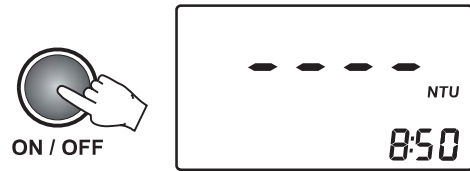

- At the end of the measurement, the third calibration point (100 NTU) is displayed on the primary LCD, "CAL P.3" on the secondary LCD, and "READ" tag will blink.
- At this moment it is possible to exit calibration by pressing CAL. The instrument will memorize the two-point calibration data and will return to measurement mode.

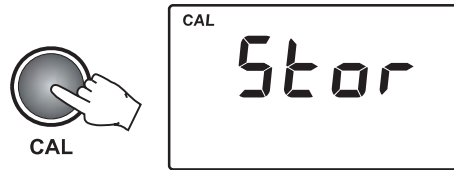
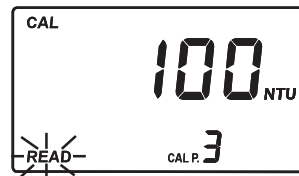

THREE-POINT CALIBRATION

To perform a three-point calibration, continue the procedure with the following steps:

- Remove the second standard cuvet.
- Place the 100 NTU standard cuvet (or the prepared formazin standard) into the holder, with the cuvet mark aligned with the sign on the instrument.
- Close the lid and press READ ►. The display will show blinking dashes and the icons for cuvet, detectors and lamp will appear during measurement.
- At the end of the measurement, the fourth calibration point (750 NTU) is displayed on the primary LCD and "CAL P.4" on the secondary LCD.
- At this moment it is possible to exit calibration by pressing CAL. The instrument will memorize the three-point calibration data and will return to measurement mode.

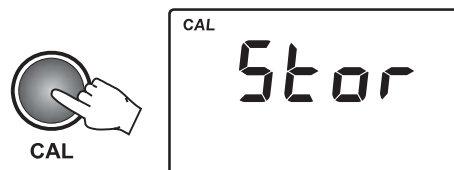
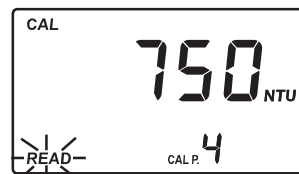
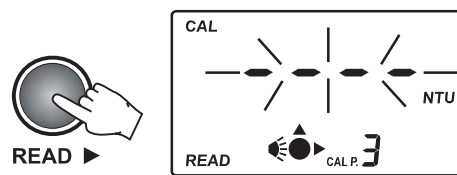
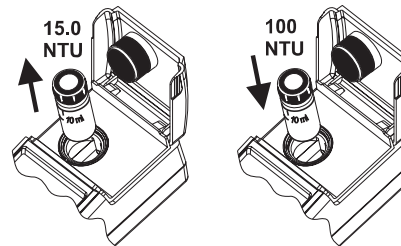

FOUR-POINT CALIBRATION

To perform a four-point calibration, continue the procedure with the following steps:

- Remove the third standard cuvet.
- Place the 750 NTU standard cuvet (or the prepared formazin standard) into the holder, with the cuvet mark aligned with the sign on the instrument.

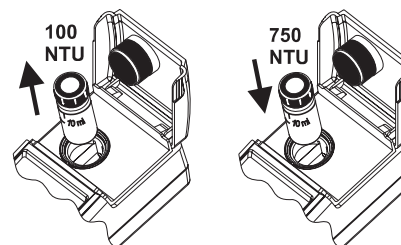

- Close the lid and press READ ►. The display will show blinking dashes and the icons for cuvet, detectors and lamp will appear during measurement.
- At the end of the measurement, the four-point calibration is completed and the instrument returns automatically to measurement mode.

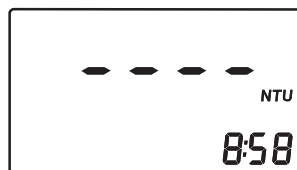
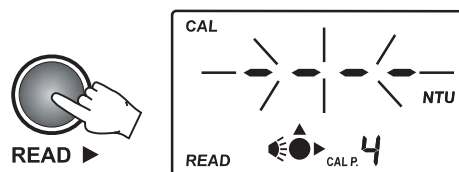

OUT CAL RANGE FUNCTION

The instrument has an **Out Cal Range** function to prevent taking measurements in a range where the calibration does not assure the best results. The range where the calibration assures correct measurements is up to 40 NTU for two-point calibration and up to 150% of the third point value for three-point calibration. The display will show a blinking “CAL” tag each time the measurements are taken outside the calibration range.

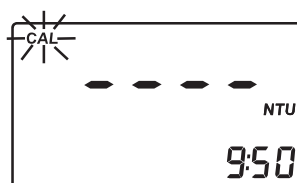

CALIBRATION ERRORS

- If the read value during calibration is too far from the set value, the instrument will show “-LO-” or “-HI-” error.
- If the calculated calibration coefficients are outside a certain range, the “CAL Err” message is displayed.

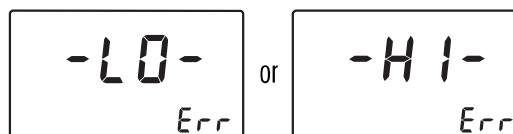

CALIBRATION DELETION

HI 98703 is factory calibrated. It is possible to restore factory calibration by deleting last performed calibration. To delete last calibration, follow the next steps:

- Enter the GLP feature by pressing GLP ▲. The date of the last calibration will be displayed on the LCD.
- Press READ ► to see the information related to calibration. The last panel is the one with delete calibration.
- Press SETUP/DEL to delete the current calibration. After deletion the instrument will automatically return to measurement mode.

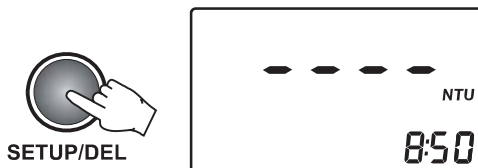
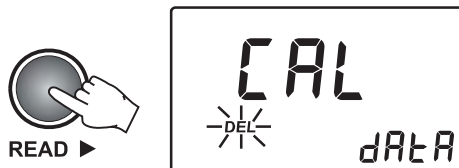
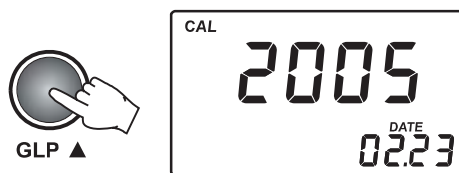



OAKION® Waterproof EcoTestr™ pH 2 Pocket Meter

Easy-to-read display with an easy-to-afford price!

pH

- Ergonomically designed LCD means measurements can be seen at a glance
- Economical and easy to use
- Waterproof and dustproof housing designed for use in dirty or damp field conditions

Simply dip and read—the orientation of the display means there is no need to turn your head or tilt the tester. This low-cost meter is perfect for most applications. The single-junction electrode is recessed to protect against breakage. The unit offers up to three-point calibration with autobuffer recognition for quick calibrations. Automatic temperature compensation ensures accurate reading under changing conditions. Hold function allows you to lock a measured value. Auto-off feature prolongs battery life. Built-in belt clip allows you to hang your meter when not in use.

What's included: four 1.5 V button cell batteries.



35423-10

Specifications



Range: 0.0 to 14.0 pH	Calibration: up to three point	Power: four 1.5 V button cell batteries (included)
Resolution: 0.1 pH	Buffer recognition: 4.0, 7.0, or 10.0	Battery life: >300 hours
Accuracy: ±0.1 pH	Operating temperature: 32 to 122°F (0 to 50°C)	Dimensions (W x H x D): 1 5/8" x 6 1/4" x 1 1/8" (3.9 x 15.9 x 2.9 cm)
Temperature compensation: automatic	Display: three-digit vertical LCD	

Catalog number	Description	Price
S-35423-10	EcoTestr pH 2 pocket meter	

S-09377-16 Replacement batteries, 1.5 V. Pack of 6

S-17101-45 NIST-traceable calibration for pH pocket meters (non-BNC)

OAKION® Waterproof EcoTestr™ EC, TDS, and Salt Pocket Meters

Low-cost testers are perfect for applications where lost or broken meters are a concern

CON TDS SAL

- Nonreplaceable sensor keeps the price down—great for educational or field use
- Five models to choose from depending on your parameter and range requirements

Economical conductivity, TDS, and salt pocket meters feature a large, ergonomically designed display so that you can easily view measurements at a glance—no need to turn your head or tilt the tester. Waterproof and dustproof housing is designed for use in dirty and damp field conditions. Convenient, built-in belt/pocket clip keeps the tester accessible when not in use.

Stainless steel electrodes are both rugged and chemical resistant. Additional features include auto-shutoff to prolong battery life, hold function to lock in a measured value, and self-diagnostic error messages. The TDS models also have a self-adjusting TDS factor from 0.40 to 1.0. The salt tester is factory calibrated against NaCl standards and is ideal for spot checking NaCl-based samples.

What's included: four 1.5 V button cell batteries.



Catalog number	DK-35462-30	DK-35462-35	DK-35462-10	DK-35462-15	DK-35462-50
Description	EcoTestr EC Low	EcoTestr EC High	EcoTestr TDS Low	EcoTestr TDS High	EcoTestr Salt
Range	Conductivity 0 to 1990 µS	Conductivity 0 to 19.90 mS	Conductivity 0 to 1990 ppm	Conductivity 0 to 10.0 ppt	Conductivity 0 to 10.0 ppt
Resolution	Conductivity 10 µS	Conductivity 0.1 mS	Conductivity 10 ppm	Conductivity 0.1 ppt	Conductivity 0.1 ppt
Accuracy	Conductivity ±1% FS	Conductivity ±2% FS	Conductivity ±1% FS	Conductivity ±2% FS	Conductivity ±1% FS
Temperature compensation	Automatic, 0 to 50°C, 2% per °C				
Calibration	One-point digital calibration				
Display	3.5-digit, 1-line LCD				
Power	Four 1.5 V batteries (included), >200 hours life				
Dimensions (L x W x H)	6 1/4" x 1 5/8" x 1 1/8" (15.9 x 4.1 x 2.9 cm)				
Price					



35462-35

DK-09377-16 Replacement batteries, 1.5 V. Pack of 6

DK-17090-30 NIST-traceable calibration for conductivity meters

ECO Testr pH 2

pH
0.0 to 14.0 pH



Solutions For Water Analysis



Water/Wastewater Treatment



Environmental Monitoring



Education

- Auto Buffer Recognition
- 3-Point Calibration
- Automatic Temperature Compensation
- Waterproof

ECO Testr pH 2

Specifications	
Range	0.0 to 14.0 pH
Resolution	0.1 pH
Accuracy	±0.1 pH
Calibration	Up to 3-point (4.0, 7.0, 10.0), auto-recognition. Calibration standard(s) sold separately
Automatic Temperature Compensation	Yes
Non-Volatile Memory	Yes
Hold Function	Yes
Auto-Off	8.5 mins after last key press
LCD Display	3 1/2 digit with annunciator
Power	(4) A76 / LR44 batteries included
Operating Temp.	0 to 50 °C
Ingress Protection	IP67 rating ; waterproof
Dimension (LxWxH)/Weight	Tester: 16.3 x 4.5 x 3 cm ; 90 g Packed : 24.5 x 13.5 x 4.5 cm ; 137 g

Applications

- Hydroponics • Agriculture • Aquaculture & Aquariums
- Pools & Spas • Education • Cooling Towers • Water Treatment • Environmental Monitoring • Food & Beverage Manufacturing • Printing and more!



< Transparent cap for samples and storage

Pocket clip >



Batteries included

◀ Please refer to inside for operating instructions

Eutech Instruments
www.eutechinst.com

Oakton Instruments
www.4oakton.com

Part of Thermo Fisher Scientific

CE

1 Year Warranty
Made in Singapore



35423-10

N374



68X461009 08/10 Rev A

EUTECH INSTRUMENTS OAKTON®

Operating Instructions EcoTestr pH 2 Waterproof Pocket Tester

Conditioning Before First Use: Precipitation of the sensor electrolyte may cause white crystals to form around the cap. This is normal and does not affect the tester's performance.

1. Remove the transparent cap and add 20 mm of tap water or pH buffer (approximately ½ full)
2. Recap the EcoTestr and soak* for one hour (or less if sensor was recently hydrated)
3. Rinse the cap after use
4. The sensor is now activated and ready for use

Measurement:

1. Remove cap and press to turn on the tester
2. Dip sensor in at least 20 mm of test solution
3. Stir once and let the reading stabilize. Note the measured value
4. To hold reading, press . Screen flashes **HO** once, then displays measurement with blinking unit (pH) to indicate that tester is in the hold mode. Press again to cancel hold mode (**HC**)
5. Press to shut the tester off

Note: Tester automatically shuts off after 8.5 minutes of non-use to conserve batteries.

Calibration: The EcoTestr is factory calibrated. However, to ensure accuracy, regular calibration is recommended. **Note:** Calibration standard(s) sold separately.

1. This tester allows up to 3-point calibration. Start with pH 7.00 buffer
2. Press to turn on the tester
3. Dip sensor in pH buffer, stir gently and wait for the value to stabilize
4. Press to begin the calibration. Display blinks **CAL** momentarily, then blinks the default reading
5. To accept the calibration, press . If successful, (**Ent**) is shown and after a few seconds measurement is resumed
6. To calibrate additional point(s), repeat steps 3-5 using pH 4.0 and/or pH 10.0 buffer(s)
7. To abort calibration, press to escape (**ESC**)

Maintenance:

1. Rinse sensor with clean water after each use
2. In harsh samples, take readings quickly, then rinse sensor immediately to remove residues and prevent electrode contamination

Useful Notes:

1. To avoid cross contamination, rinse between samples and calibration standards with clean water
2. To maintain tester accuracy, calibrate at regular intervals as required
3. For long-term storage, fill cap with 20 mm of storage solution (NOT de-ionized water) and replace cap*. This will keep sensor conditioned and ready for next use
4. Not recommended for prolonged use with solutions containing heavy metals, proteins, tris, or sulfides which will clog the junction leading to slow response and eventual failure

* The tester cap is not leak-proof. Please keep tester upright during soaking.

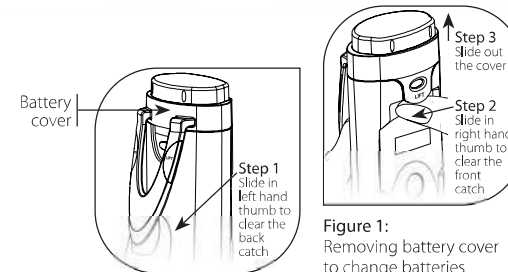

Figure 1:
Removing battery cover to change batteries

Changing Batteries:

1. To remove batteries, hold the tester on the left hand with the left thumb slide under the back clip of the cover. This will release the back catch
2. Next, hold the cover with your right hand, at the same time release the front catch with your right thumb. Slide up to remove the battery cover (Figure 1)
3. Replace old batteries with fresh ones. Note polarity as shown in battery compartment
4. No re-calibration is required after battery change. The tester's non-volatile memory function retains calibration settings

Your EcoTestr includes (4) pre-installed 1.5V alkaline batteries. LR44 or A76 battery types are suitable and commonly available. Replace all (4) batteries together. Waiting too long to replace the batteries can lead to inaccurate readings and is the most common cause of problems.

Error Messages:

1. **bAt** – Batteries are weak and need replacement
2. **Err** – Wrong or bad buffer value (out of range) and/or the sensor is failing. Use fresh buffer. Replace batteries. Note: when sensor fails, it cannot be replaced
3. **Or/Ur** – Over or Under range signal; sensor is dry/contaminated/damaged/not fully immersed

Reset Option: Reset option allows you to restore the calibration back to factory default settings.

1. Press to turn off tester
2. Press and hold , then press to turn the tester on. The display shows a flashing **rSt** (reset)
3. Press again to confirm reset (**Ent**) or press to escape (**ESC**) reset option

Warranty: This instrument is supplied with a warranty against manufacturing defects for a period of one year from date of purchase.

Tester & Accessories Ordering Information:

Eutech Order Code	Oakton Order Code	Description
ECOPHTEST2	35423-10	EcoTestr pH 2
ECPOUCH01	35624-45	Soft carrying case with belt-loop
ECBU4BT	00654-00	pH 4.01 buffer solution, 480 ml bottle
ECBU7BT	00654-04	pH 7.00 buffer solution, 480 ml bottle
ECBU10BT	00654-08	pH 10.01 buffer solution, 480 ml bottle
ECRE005	00653-04	Storage solution for pH sensor, 480 ml bottle
ECDPCBT	00653-06	Sensor cleaning solution, 480 ml bottle

CSMP Attachment 5: Supplemental Information

Section 8 References

Project Plans and Specifications for:

DONNER PASS ROAD IMPROVEMENTS (CA FLAP NEV 40(1))

State Water Resources Control Board (2009). Order 2009-0009-DWQ, NPDES General Permit No. CAS000002: National Pollutant Discharges Elimination System (NPDES) California General Permit for Storm Water Discharge Associated with Construction and Land Disturbing Activities. Available on-line at:

http://www.waterboards.ca.gov/water_issues/programs/stormwater/construction.shtml.

State Water Resources Control Board (2010). Order 2010-0014-DWQ, NPDES General Permit No. CAS000002: National Pollutant Discharges Elimination System (NPDES) California General Permit for Storm Water Discharge Associated with Construction and Land Disturbing Activities. Available on-line at:

http://www.waterboards.ca.gov/water_issues/programs/stormwater/construction.shtml.

State Water Resources Control Board (2012). Order 2012-0006-DWQ, NPDES General Permit No. CAS000002: National Pollutant Discharges Elimination System (NPDES) California General Permit for Storm Water Discharge Associated with Construction and Land Disturbing Activities. Available on-line at:

http://www.waterboards.ca.gov/water_issues/programs/stormwater/construction.shtml.

CASQA 2009, *Stormwater BMP Handbook Portal: Construction*, November 2009, www.casqa.org

Appendix A: Calculations

Rainfall Erosivity
Factor (R) = 402.69

Facility Information

Start Date: 05/25/2020	Latitude: 39.3147
End Date: 05/25/2021	Longitude: -120.3442

Calculation Results

Rainfall erosivity factor (R Factor) = **133**

A rainfall erosivity factor of 5.0 or greater has been calculated for your site's period of construction.

You do NOT qualify for a waiver from NPDES permitting requirements and must seek Construction General Permit (CGP) coverage. If you are located in an area where EPA is the permitting authority, you must submit a Notice of Intent (NOI) through the NPDES eReporting Tool (NeT). Otherwise, you must seek coverage under your state's CGP.

Facility Information

Start Date: 05/25/2022	Latitude: 39.3147
End Date: 05/25/2023	Longitude: -120.3442

Calculation Results

Rainfall erosivity factor (R Factor) = **133**

A rainfall erosivity factor of 5.0 or greater has been calculated for your site's period of construction.

You do NOT qualify for a waiver from NPDES permitting requirements and must seek Construction General Permit (CGP) coverage. If you are located in an area where EPA is the permitting authority, you must submit a Notice of Intent (NOI) through the NPDES eReporting Tool (NeT). Otherwise, you must seek coverage under your state's CGP.

Facility Information

Start Date: 05/25/2021	Latitude: 39.3147
End Date: 05/25/2022	Longitude: -120.3442

Calculation Results

Rainfall erosivity factor (R Factor) = **133**

A rainfall erosivity factor of 5.0 or greater has been calculated for your site's period of construction.

You do NOT qualify for a waiver from NPDES permitting requirements and must seek Construction General Permit (CGP) coverage. If you are located in an area where EPA is the permitting authority, you must submit a Notice of Intent (NOI) through the NPDES eReporting Tool (NeT). Otherwise, you must seek coverage under your state's CGP.

Facility Information

Start Date: 05/25/2023	Latitude: 39.3147
End Date: 08/31/2023	Longitude: -120.3442

Calculation Results

Rainfall erosivity factor (R Factor) = **3.69**

A rainfall erosivity factor of less than 5.0 has been calculated for your site and period of construction. If you are located in an area where EPA is the permitting authority, you can submit a LEW through EPA's NPDES eReporting Tool (NeT). Otherwise, contact your state permitting authority to determine if you are eligible for a waiver from NPDES permitting requirements.

If you submitted a LEW through EPA's NeT and your construction activity ultimately extends past the project completion date you specified above, you must recalculate the R factor using the original start date and a new project completion date. If the recalculated R factor is still less than 5.0, you must submit a modification to your LEW through NeT before the end of the original construction period. If the new R factor is 5.0 or greater, you must submit a Notice of Intent (NOI) instead to be covered by the Construction General Permit (CGP) before the original project completion date.

K Factor: 0.2



Caltrans Water Quality Planning Tool

The Water Quality Planning Tool was created to help planners and designers comply with environmental permits. It uses a map interface to find information based on a project's location. **This application is being updated for digital accessibility and will continue to function while updates are in progress.**

- POST AVIES
- Rainfall Distribution
- RWQCB Boundaries
- USGS Topo Maps
- Watershed Boundary Dataset

Risk Level Determination

- Erosivity Index
- K Factor
- R Factor [\(calculations\)](#)
- LS Factor
- Soil Details

Compliance Storm Events

- 5-yr 24-hr North
- 10-yr 24-hr North
- 5-yr 24-hr South
- 10-yr 24-hr South

Distance and Area

Measure

Feet: 0
Acres: 0

Postmile Lookup

Show postmile lookup

Information
Hover over a layer name for a description. Additional information, tables, coordinates, and links are below the map.
[Help](#)

Map Satellite High Contrast

39.314722, -120.344218

Soil K-Factor: 0.2

The soil-erodibility factor (K) represents: (1) the susceptibility of soil or surface material to erosion, (2) the transportability of the sediment, and (3) the amount and rate of runoff given a particular rainfall input, as measured under a standard condition. Fine-textured soils that are high in clay have low K values (about 0.05 to 0.15) because the particles are resistant to detachment. Coarse-textured soils, such as sandy soils, also have low K values (about 0.05 to 0.2) because of high infiltration resulting in low runoff, although these particles are easily detached. Medium-textured soils, such as a silt loam, have moderate K values (about 0.25 to 0.45) because they are moderately susceptible to particle detachment and they produce runoff at moderate rates. Soils having a high silt content are especially susceptible to erosion and have high K values, which can exceed 0.45 and can be as large as 0.65. Silt-size particles are easily detached and tend to crust, producing high runoff rates and large runoff volumes. For more information on the Construction General Permit and references for the RUSLE, please visit the SWROB Construction Stormwater Program.

Postmile Lookup

Map data ©2020 Google [Terms of Use](#) [Report a map error](#)

Watershed Information

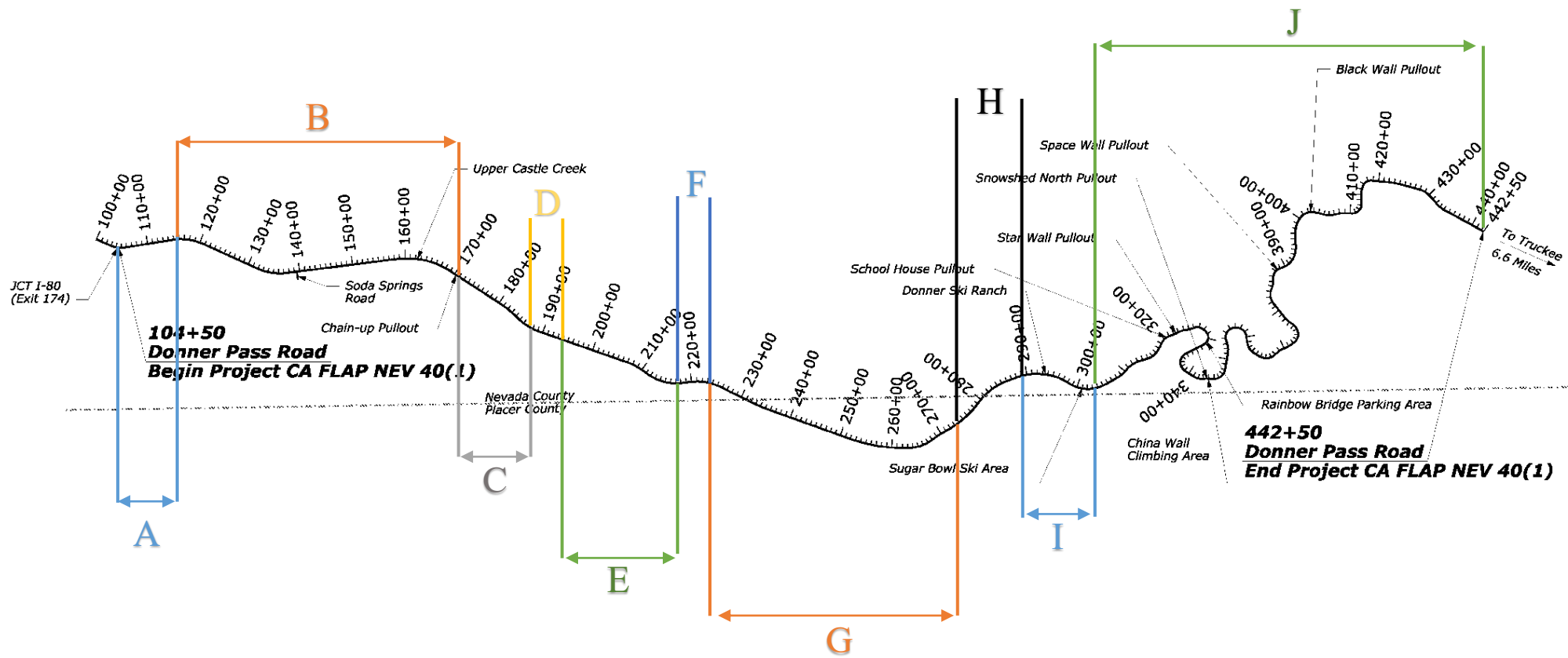

High Risk Receiving Water Shed



Caltrans Water Quality Planning Tool

The Water Quality Planning Tool was created to help planners and designers comply with environmental permits. It uses a map interface to find information based on a project's location. This application is being updated for digital accessibility and will continue to function while updates are in progress.

- 203(d) List and TMDLs 2014-2016 (Legend)
- Areas of Special Biological Significance
- Arid and Semi-Arid Regions
- Caltrans Districts
- Caltrans Facilities
- Caltrans Tier 1 Monitoring Sites
- Calwater Watersheds
- Coastal Zone
- Counties
- Geologic Map (Legend)
- High Risk Receiving Watersheds
- Monthly Precipitation
- MS4 Areas
- Post Miles
- Rainfall Distribution
- RWQCB Boundaries
- USGS Topo Maps
- Watershed Boundary Dataset
- Risk Level Determination**
 - Erosivity Index
 - K Factor

Information
Hover over a layer name for a description. Additional information, tables, coordinates, and links are below the map.
[Help](#)



Watershed Information

Sediment Risk Factor Worksheet		Entry
A) R Factor		
<p>Analyses of data indicated that when factors other than rainfall are held constant, soil loss is directly proportional to a rainfall factor composed of total storm kinetic energy (E) times the maximum 30-min intensity (I30) (Wischmeier and Smith, 1958). The numerical value of R is the average annual sum of EI30 for storm events during a rainfall record of at least 22 years. "Isoerodent" maps were developed based on R values calculated for more than 1000 locations in the Western U.S. Refer to the link below to determine the R factor for the project site.</p> <p>http://cfpub.epa.gov/npdes/stormwater/LEW/lewCalculator.cfm</p>		
R Factor Value		402.69
B) K Factor (weighted average, by area, for all site soils)		
<p>The soil-erodibility factor K represents: (1) susceptibility of soil or surface material to erosion, (2) transportability of the sediment, and (3) the amount and rate of runoff given a particular rainfall input, as measured under a standard condition. Fine-textured soils that are high in clay have low K values (about 0.05 to 0.15) because the particles are resistant to detachment. Coarse-textured soils, such as sandy soils, also have low K values (about 0.05 to 0.2) because of high infiltration resulting in low runoff even though these particles are easily detached. Medium-textured soils, such as a silt loam, have moderate K values (about 0.25 to 0.45) because they are moderately susceptible to particle detachment and they produce runoff at moderate rates. Soils having a high silt content are especially susceptible to erosion and have high K values, which can exceed 0.45 and can be as large as 0.65. Silt-size particles are easily detached and tend to crust, producing high rates and large volumes of runoff. Use Site-specific data must be submitted.</p> <p>Site-specific K factor guidance</p>		
K Factor Value		0.2
C) LS Factor (weighted average, by area, for all slopes)		
<p>The effect of topography on erosion is accounted for by the LS factor, which combines the effects of a hillslope-length factor, L, and a hillslope-gradient factor, S. Generally speaking, as hillslope length and/or hillslope gradient increase, soil loss increases. As hillslope length increases, total soil loss and soil loss per unit area increase due to the progressive accumulation of runoff in the downslope direction. As the hillslope gradient increases, the velocity and erosivity of runoff increases. Use the LS table located in separate tab of this spreadsheet to determine LS factors. Estimate the weighted LS for the site prior to construction.</p> <p>1</p>		
LS Factor Value		1.89
Watershed Erosion Estimate (=RxKxLS) in tons/acre		152.21682
Site Sediment Risk Factor		High
Low Sediment Risk: < 15 tons/acre		
Medium Sediment Risk: >=15 and <75 tons/acre		
High Sediment Risk: >= 75 tons/acre		

Receiving Water (RW) Risk Factor Worksheet	Entry	Score
A. Watershed Characteristics	yes/no	
<p>A.1. Does the disturbed area discharge (either directly or indirectly) to a 303(d)-listed waterbody impaired by sediment? For help with impaired waterbodies please check the attached worksheet or visit the link below:</p> <p>2006 Approved Sediment-impaired WBs Worksheet</p> <p>http://www.waterboards.ca.gov/water_issues/programs/tmdl/303d_lists2006_epa.shtml</p> <p style="text-align: center;"><u>OR</u></p>	Yes	High
<p>A.2. Does the disturbed area discharge to a waterbody with designated beneficial uses of SPAWN & COLD & MIGRATORY?</p> <p>http://www.ice.ucdavis.edu/geowbs/asp/wbquse.asp</p>		

		Combined Risk Level Matrix		
		<u>Sediment Risk</u>		
<u>Receiving Water Risk</u>		Low	Medium	High
	Low	Level 1	Level 2	
High	Level 2		Level 3	

Project Sediment Risk: **High**
 Project RW Risk: **High**
 Project Combined Risk: **Level 3**

Appendix B: Site Maps

STATE	PROJECT	SHEET NUMBER
CA	CA FLAP NEV 40(1) DONNER PASS	A1

U.S. DEPARTMENT OF TRANSPORTATION FEDERAL HIGHWAY ADMINISTRATION

INDEX TO SHEETS	
SHEET	DESCRIPTION
A GENERAL INFORMATION	
A	TITLE SHEET
A2 - A3	CONVENTIONAL PLAN SYMBOLS & ABBREVIATIONS
A4	SURVEY CONTROL
A5	SITE MAP
A6 - A7	TYPICAL SECTIONS
A8 - A9	PAVEMENT STRUCTURAL SECTIONS
A10 - A11	TYPICAL SECTIONS APPROACH ROADS
B SUMMARIES	
B1 - B4	SUMMARY OF QUANTITIES
B5	GRADING SUMMARY
B6 - B7	DRAINAGE SUMMARY
B8 - B9	SURFACING SUMMARY
B10	GUARDRAIL SUMMARY
B11	REMOVAL SUMMARY
B12 - B13	TABULATION OF QUANTITIES
B14 - B16	PERMANENT SIGN SUMMARY
B17	PERMANENT PAVEMENT MARKING SUMMARY
C MAINLINE PLAN & PROFILE	
C1 - C28	DONNER PASS PLAN AND PROFILES
D MINOR ROAD, PULLOUT, PARKING, GEOMETRIC DETAILS	
D1	RAINBOW BRIDGE PARKING AREA
D2 - D7	PULLOUT DETAILS
D8	DONNER SIG RANCH STORM SYSTEM
F DIVISION 200 STANDARDS/DETAILS AND SPECIALS	
F1	EMBANKMENT BENCHING
F2	204-A SINKHOLE PATCHING DETAIL
G DIVISION 250 STANDARDS/DETAILS AND SPECIALS	
G1	ROCKERY WALL LAYOUT
G2	ROCKERY DETAIL
G3 - G25	ROCK CUT PLANS
G26 - G27	260-A ROCK REINFORCEMENT DETAIL
G28 - G30	GEOGRID REINFORCED MSE WALL DETAILS
G31	C251-50 PLACED REPAIR AT CULVERT OUTLETS
CONTINUED ON SHEET A2	

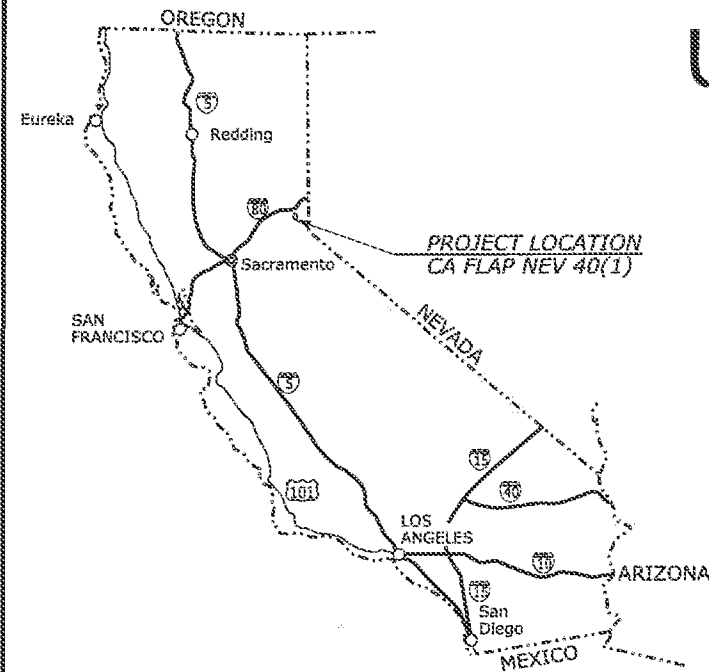

KEY MAP OF CALIFORNIA

TYPE OF CONSTRUCTION:

Restoration, Resurfacing, and Rehabilitation (3R+)
(Widening, Grading, Drainage and Asphalt Concrete Pavement)

DESIGN DESIGNATIONS:

- ADT (2020) ----- 1902
- ADT (2040) ----- 2321
- DHV ----- 8
- D ----- 50%
- T ----- 2%
- V ----- 35 mph
- e(max) ----- 8%

U.S. CUSTOMARY DIMENSIONS:

Slopes are expressed as RISE:RUN

SPECIFICATIONS:

"STANDARD SPECIFICATIONS FOR CONSTRUCTION OF ROADS AND BRIDGES ON FEDERAL HIGHWAY PROJECTS, FP-14"

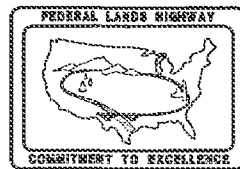

PLANS FOR PROPOSED
**CA FLAP NEV 40(1)
DONNER PASS ROAD**
TAHOE NATIONAL FOREST
NEVADA COUNTY, CA
PLACER COUNTY, CA
LENGTH 6.40 miles

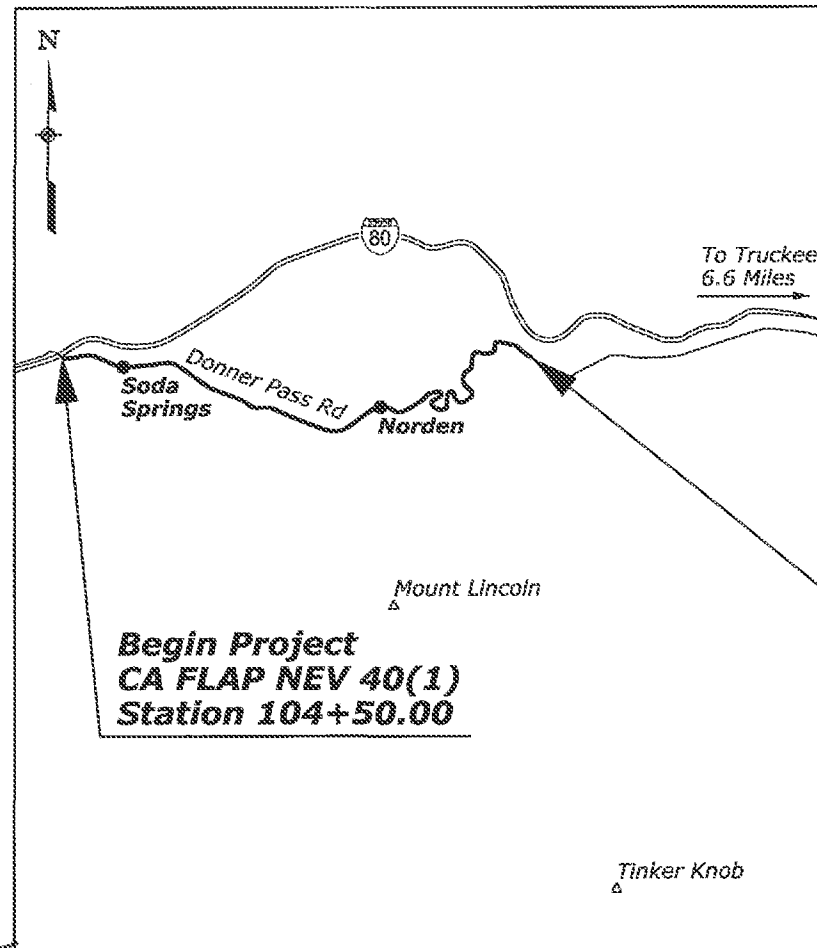

**End Project
CA FLAP NEV 40(1)
Station 442+50.00**

**Begin Project
CA FLAP NEV 40(1)
Station 104+50.00**

PLANS PREPARED BY
MULLER
ENGINEERING COMPANY



FOR
U.S. DEPARTMENT OF TRANSPORTATION
FEDERAL HIGHWAY ADMINISTRATION
CENTRAL FEDERAL LANDS HIGHWAY DIVISION
DENVER, COLORADO

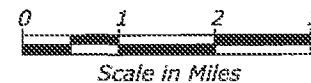

APPROVED:

[Signature]
CHIEF OF ENGINEERING
CENTRAL FEDERAL LANDS HIGHWAY DIVISION

DATE: 9/3/2019

PROJECT MANAGER	LEAD DESIGNER
M. AMBROZIAK	MULLER

8/14/2019 7:03:37 AM Q:\2015 Projects\15-030.02 Donner Pass Preliminary Design - CFLHD\CA FLAP NEV 40(1)\Roadway\CADD_Sheets\4-Gen_sht\TTL(DOWN)\CA40.dgn User: mcshton

STATE	PROJECT	SHEET NUMBER
CA	CA FLAP NEV 40(1) DONNER PASS	A5

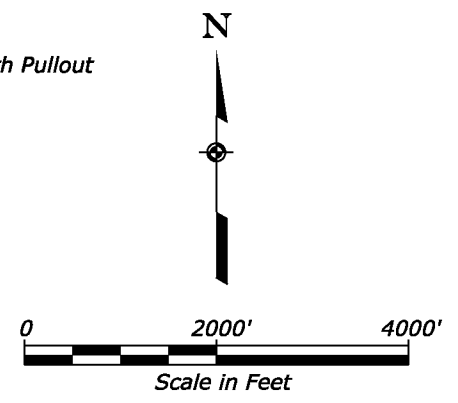
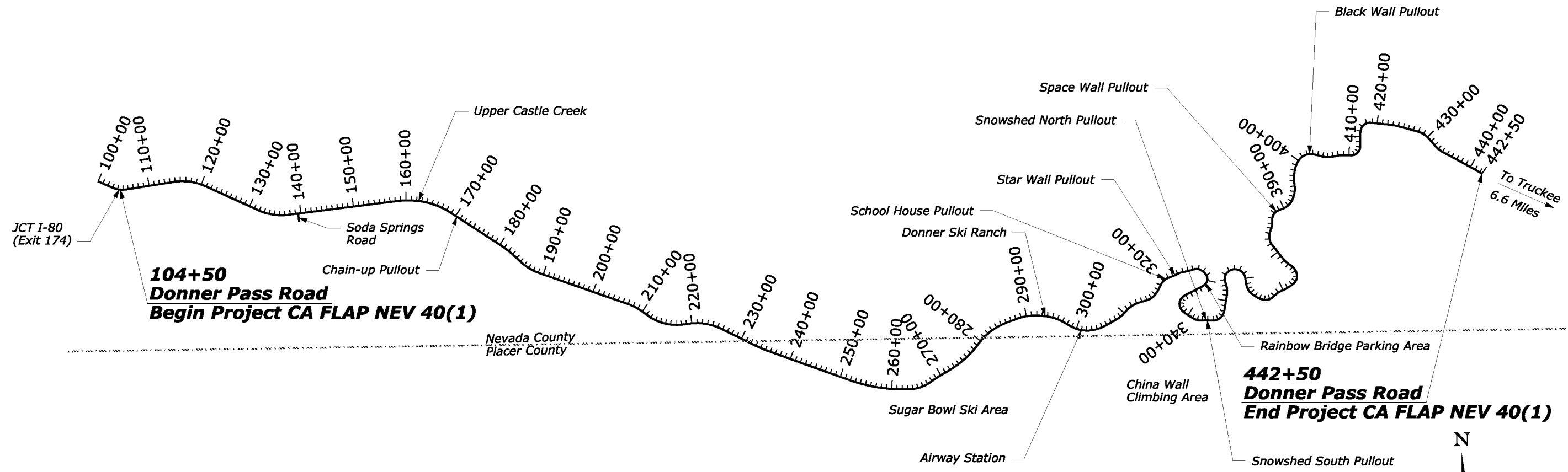
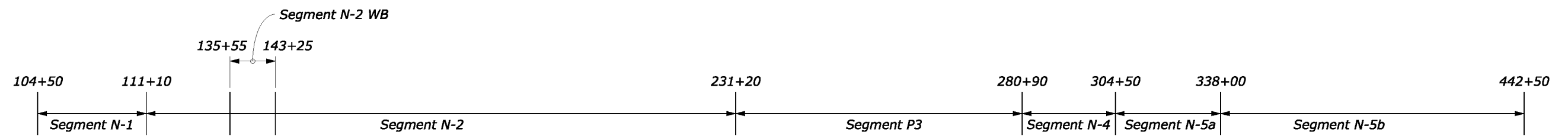

Note:

1. Available staging area include pullouts located throughout the corridor. Staging areas are limited to previously disturbed areas.
2. Segments used for pavement recommendations. See geotechnical and pavement recommendations for additional information.

U.S. DEPARTMENT OF TRANSPORTATION
FEDERAL HIGHWAY ADMINISTRATION
CENTRAL FEDERAL LANDS HIGHWAY DIVISION

SITE MAP

3/21/2019 7:03:44 AM Q:\2015 Projects\15-030.02 Donner Pass Preliminary Design - CFLHD\CA FLAP NEV 40(1)\Roadway\CADD_Sheets\4-Gen_sh\STATE(DONNV)CA40.dgn _User: mcarlison_



Project: **DONNER PASS ROAD IMPROVEMENTS**

Sheet: **WATER POLLUTION CONTROL DETAILS**

SHEET NO: WP-1

DATE:

11/15/2021

- 1) Contractor shall protect Storm Drain Inlets or Drainage holes within and downstream of the working areas prior ro construction, if any (BMP SE-10).
- 2) Street Sweeping shall be implemented throughout the project on paved roads (BMP SE-7).
- 3) Construction Entrance/Exit shall be stabilized (BMP TC-1). The potential areas are shown on the water pollution control plans. Contractor shall ensure that construction activity traffic to and from the project is limited to these controlled entrances and exits.
- 4) Contractor shall inspect on a daily basis all immediate access roads daily. At a minimum daily (when necessary) and prior to any rain event, the discharger shall remove any sediment or other construction activity related materials that are deposited on the roads (by vacuuming or sweeping).
- 5) Existing vegetation to be preserved on the site must be protected from mechanical and other injury during the construction, if there is any (BMP EC-2)
- 6) Clean up Spills and Leaks immediately with absorbent materials.
- 7) Dust Control shall be implemented throughout the project in accordance with wind erosion control BMP WE-1 and project dust control requirements.
- 8) All construction materials stored or stockpiled on site shall be protected from being transported by the forces of wind and water.
- 9) No construction-related materials, waste, spill, or residue shall be discharged from the work site to streets, drainage facilities or adjacent property by wind or runoff.
- 10) Geotextiles and mats shall be implemented beginning of Sstockpiling materials until final stabilization (BMP EC-7).
- 11) Contractor shall ensure that all storm drain inlets and perimeter controls, runoff control BMPs, and pollutant controls at entrances and exits are maintained and protected from activities that reduce their effectiveness.
- 12) Implement applicable Waste Management practices from WM list mentioned here on where indicated and required locations per current construction conditions
- 13) Implement applicable non-stormwater pollution practices from NS list mentioned here on where indicated and required locations per current construction conditions
- 14) BMPs shown here are based on the conceptual layout and grading. They may need modification to achieve compliance related to field activities.
- 15) Install linear sediment controls (e.g. Fiber Rolls (SE-5)) along the toe of the slope, face of the slope, and at the grade breaks of exposed slopes to comply with sheet flow lengths as follows:
 Slope 0-25% Sheet Flow Length not to exceed 20 ft
 Slope 25-50% Sheet Flow Length not to exceed 15 ft
 Slope > 50% Sheet Flow Length not to exceed 10 ft
- 16) Disturbed areas that will not be re-disturbed within 14 days shall be temporary stabilized.
- 17) Divert water away from construction activities where applicable using appropriate measures such as earth dike and drainage swales (EC-9) and velocity dissipation devices (EC-10) if necessary. Prevent concentrated flows from Temescal Creek and storm drain outlets. Employ the use of dikes, channels, swales, pipes, pumping, detention, and other practices to direct surface water away from construction activity. Employ measures to prevent Temescal Wash overtopping flows from entering the jobsite.
- 19) All construction, site disturbance, and vegetation removal shall be located within the delineated construction boundaries. The storage of equipment and materials, and temporary stockpiling of soil shall be located within designated areas only, and outside of natural habitat areas/channel. The limits of construction shall be delineated in the field with temporary construction fencing, staking, or flagging.
- 20) Sensitive area access restrictions (for example, flagging) need to be installed before clearing and grading begins.
- 21) Apply temporary erosion controls (EC) such as Hydroseed (EC-4), Geotextiles and Mats (EC-7) or other suitable stabilization measures to protect exposed areas during construction activities from beginning of Soil disturbing activities until final stabilization
- 23) Implement the following Non-stormwater Pollution Control BMPs and Waste Management BMPs at drainage areas and staging area:

Non-stormwater Practices (NS):	Waste management Practices (WM):
NS-1: Water Conservation Practices	WM-1: Material Delivery and Storage
NS-3: Paving and Grinding Operation	WM-2: Material Use
NS-6: Illicit Connection/Discharge	WM-3: Stockpile Management
NS-7: Portable Water/Irrigation	WM-4: Spill Prevention and Control
NS-8: Vehicle and Equipment Cleaning	WM-5: Solid Waste Management
NS-9: Vehicle and Equipment Fueling	WM-6: Hazardous Waste Management
NS-10: Vehicle and Equipment Maintenance	WM-8: Concrete Waste Management
NS-12: Concrete Curing	WM-9: Sanitary-Septic Waste Management
NS-13: Concrete Finishing	WM-10: Liquid Waste Management

Legend

implement Silt Fence (SE-1) along the project site		Potential Sampling Point	
Implement Fiber Roll (SE-5) along the project site		Site Run-on Sample Location	
Implement Gravel Bag Berm (SE-6) along the project site		General Flow Direction	
Non-stormwater Practices		Implement Fiber Rolls (SE-5) around the site	
Waste Management Practices		Hydromulch (EC-3) and Hydroseed (EC-4)	
Wind Erosion Control (WE-1)			
Paving and Grinding Operation (NS-3)			
Inlet Protection (SE-10)			
Stabilized Construction Entrance/Exit (TC-1)			

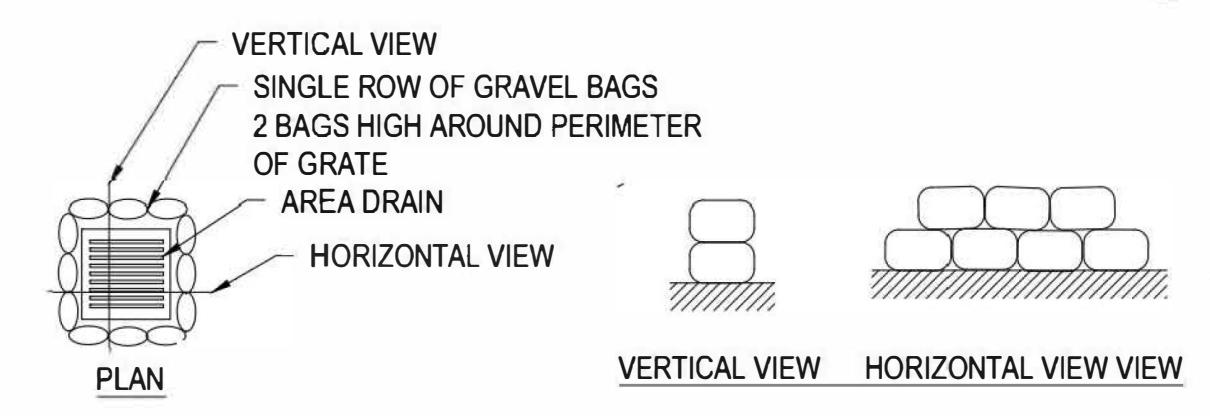

Inlet Protection (SE-10)

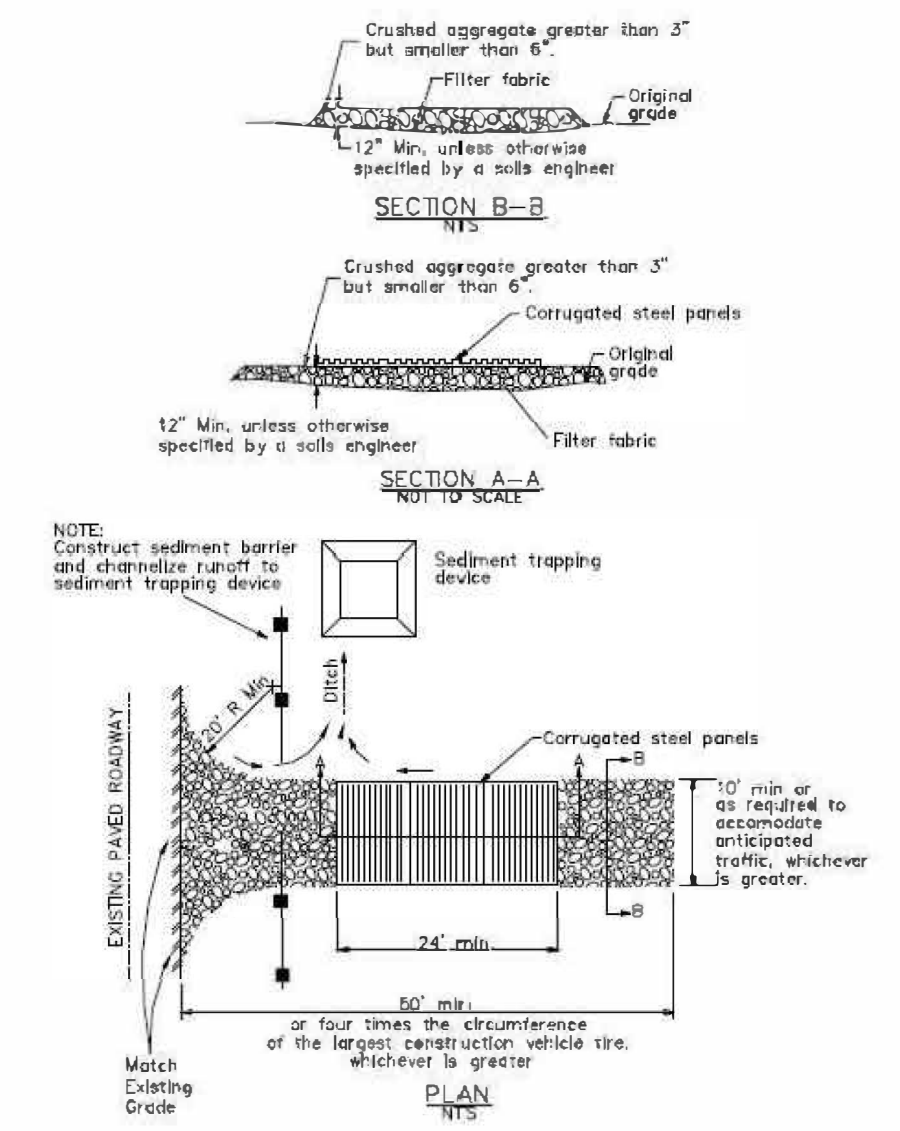

Stabilized Construction Entrance/Exit (TC-1)

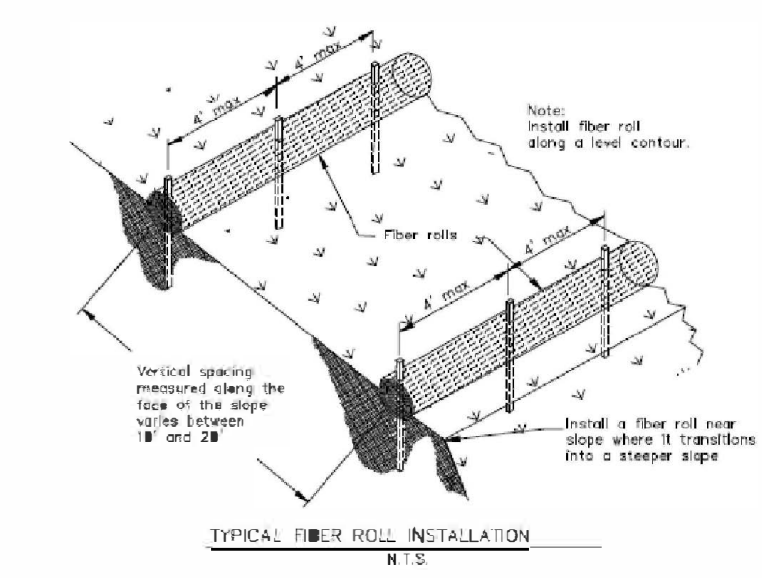

Fiber Rolls (SE-5)

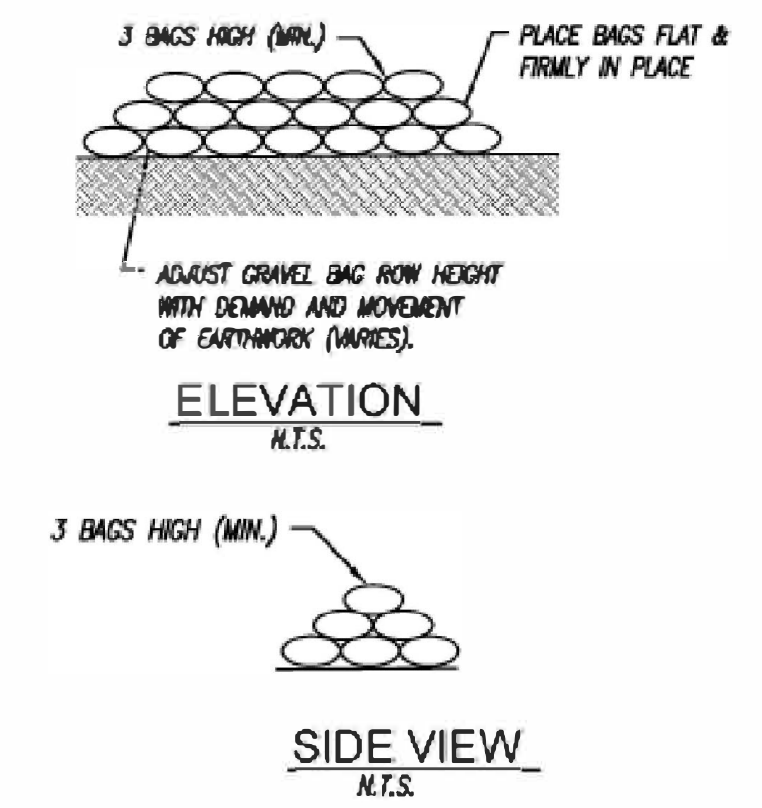

Gravel Bag Berm (SE-6)

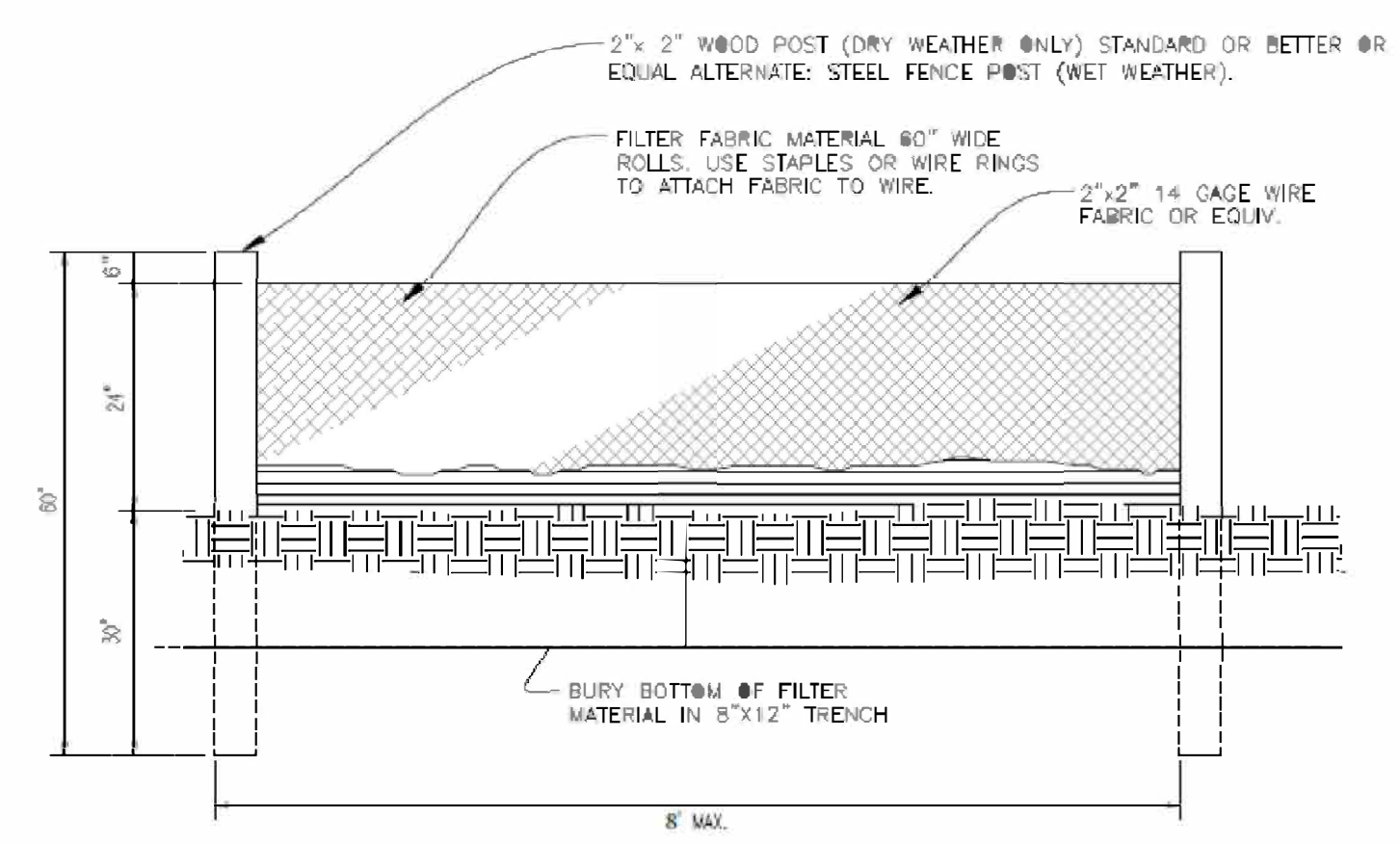

Silt Fence (SE-1)

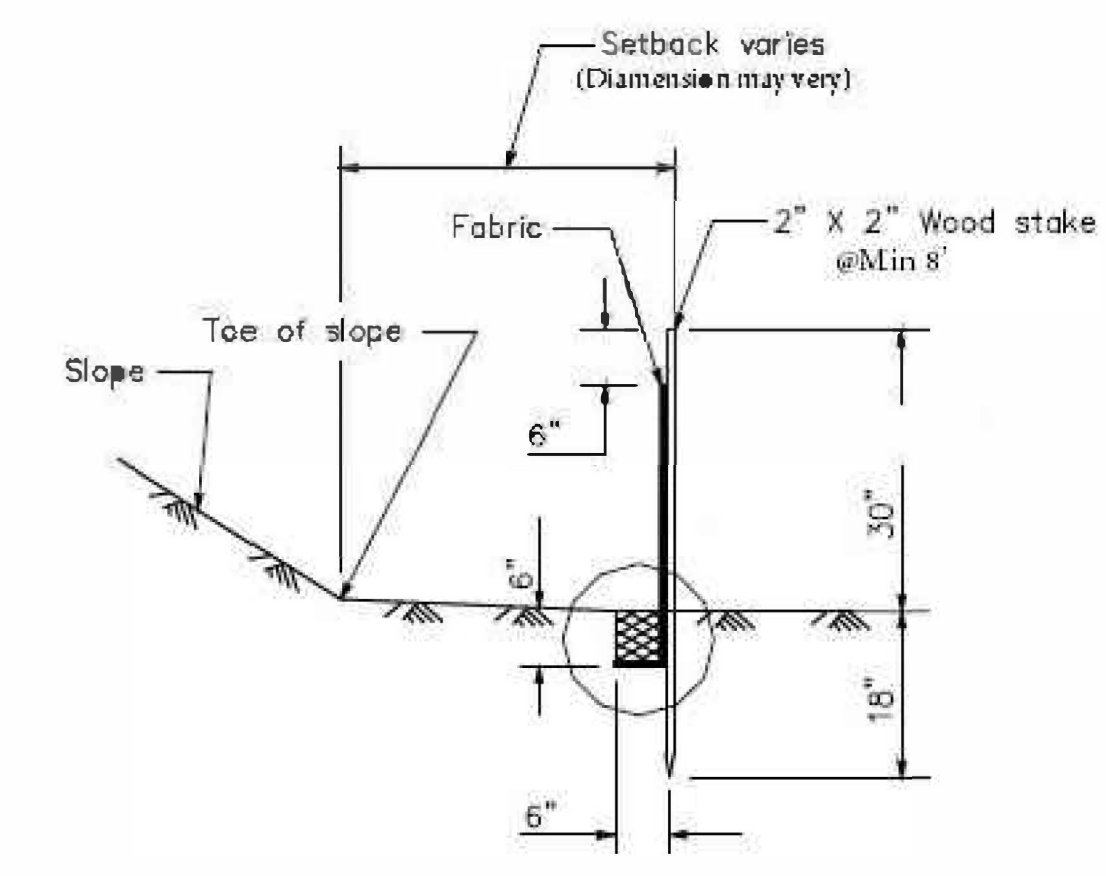



Project:
DONNER PASS ROAD
IMPROVEMENTS

Project:

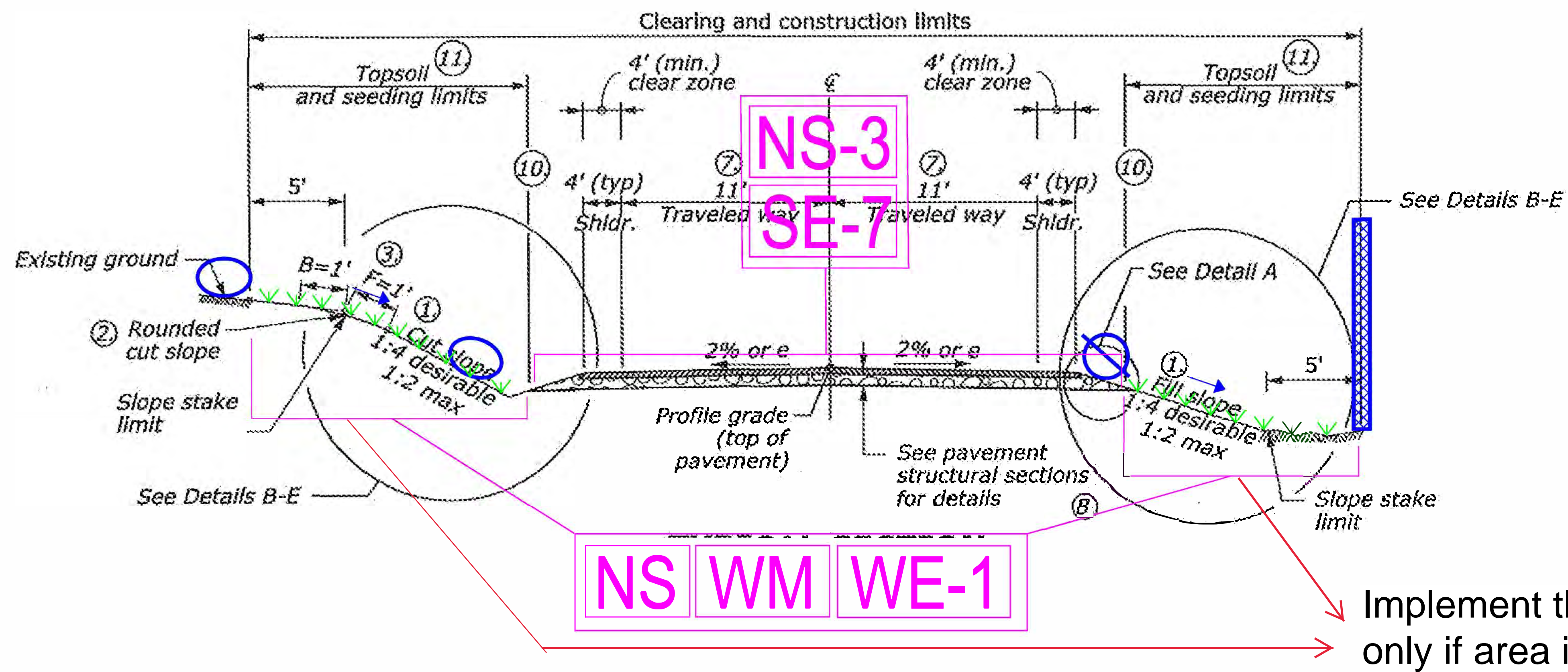

Implement these BMPs
only if area is disturbed

Typical BMP Implementation throughout the site



Staging Area Map

Sheet:
WATER POLLUTION
CONTROL DRAWING

Sheet:

SHEET NO: WP-2

DATE:

11/15/2021

WATER POLLUTION CONTROL DRAWING

NTS



Project:
**DONNER PASS ROAD
IMPROVEMENTS**

Project:

Sheet:

WATER POLLUTION
CONTROL DRAWING

SHEET NO: WP-3

DATE:

11/15/2021

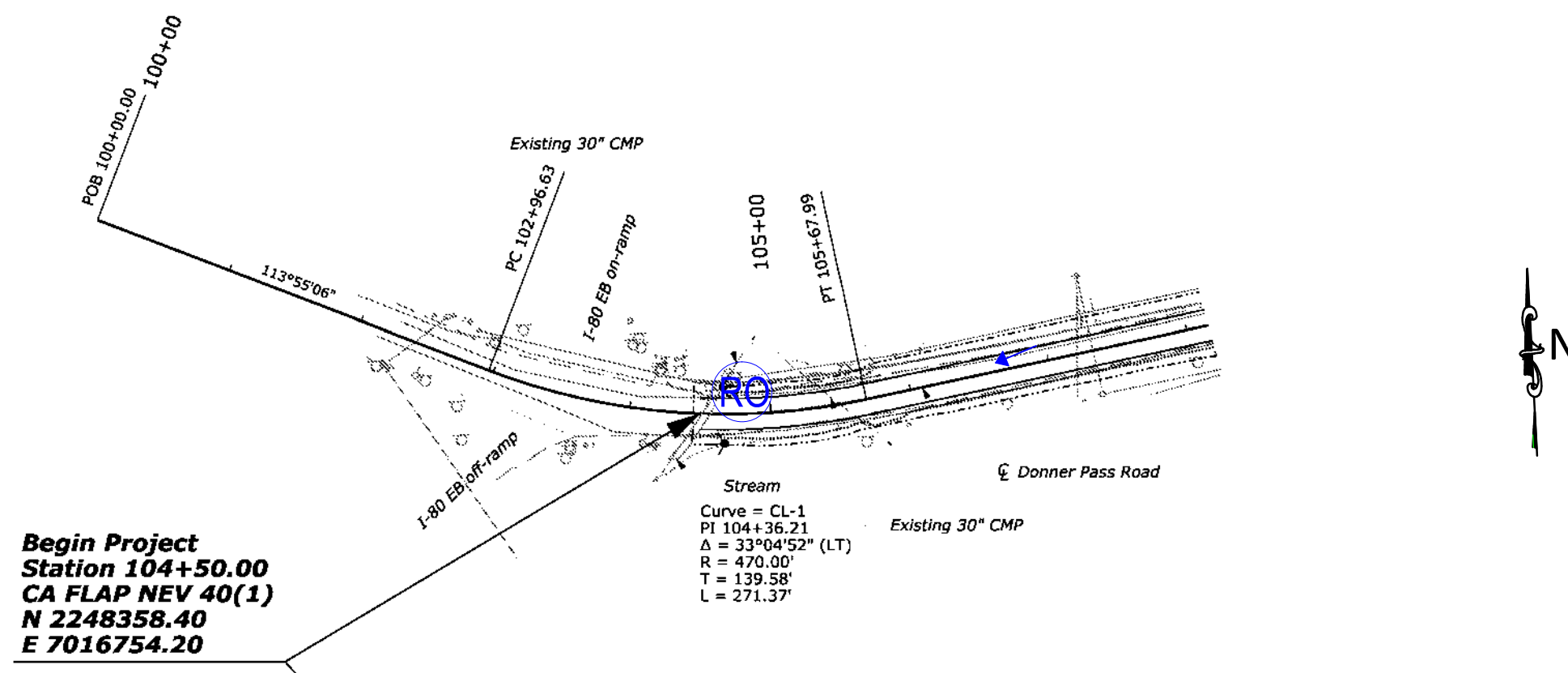

From 104+50 to 108+00

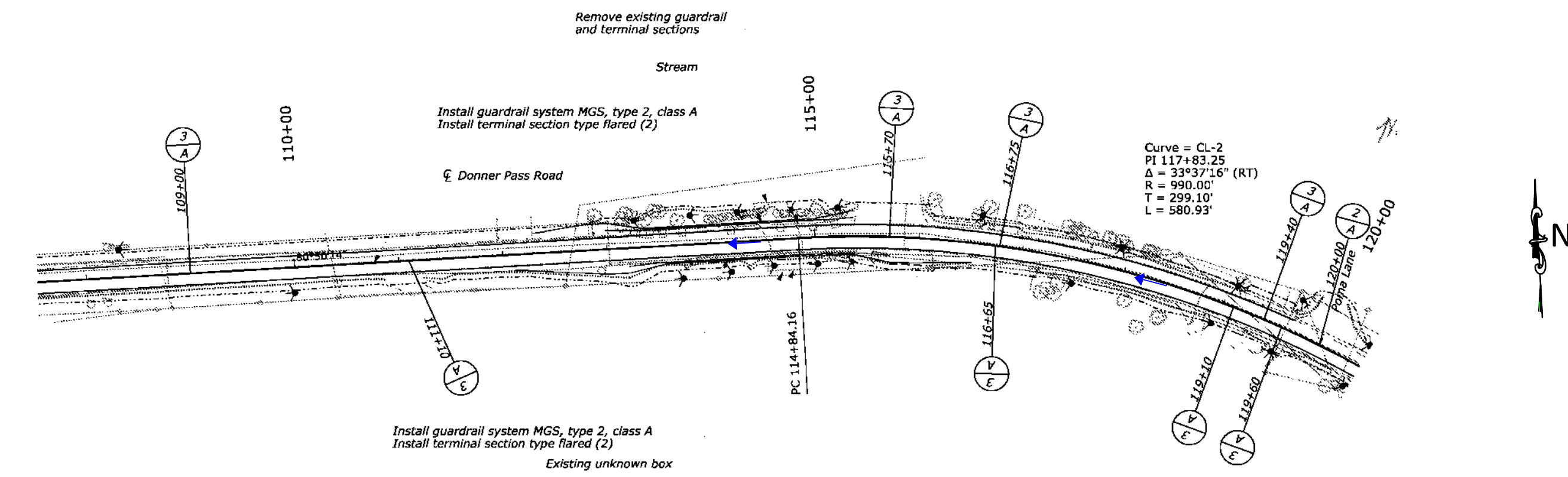

From 108+00 to 120+00

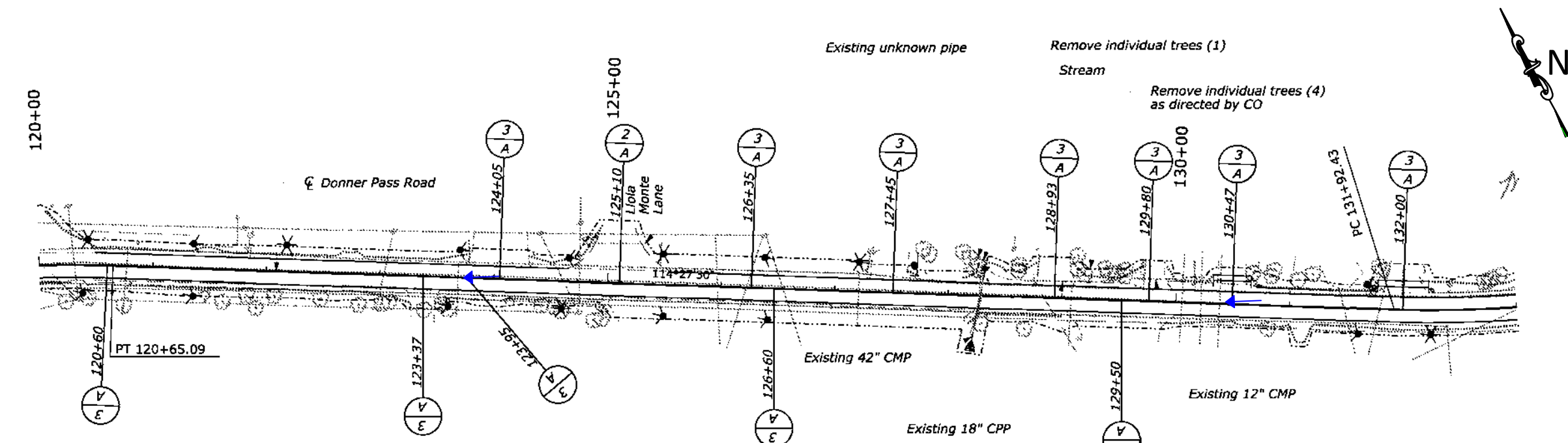

From 120+00 to 133+00

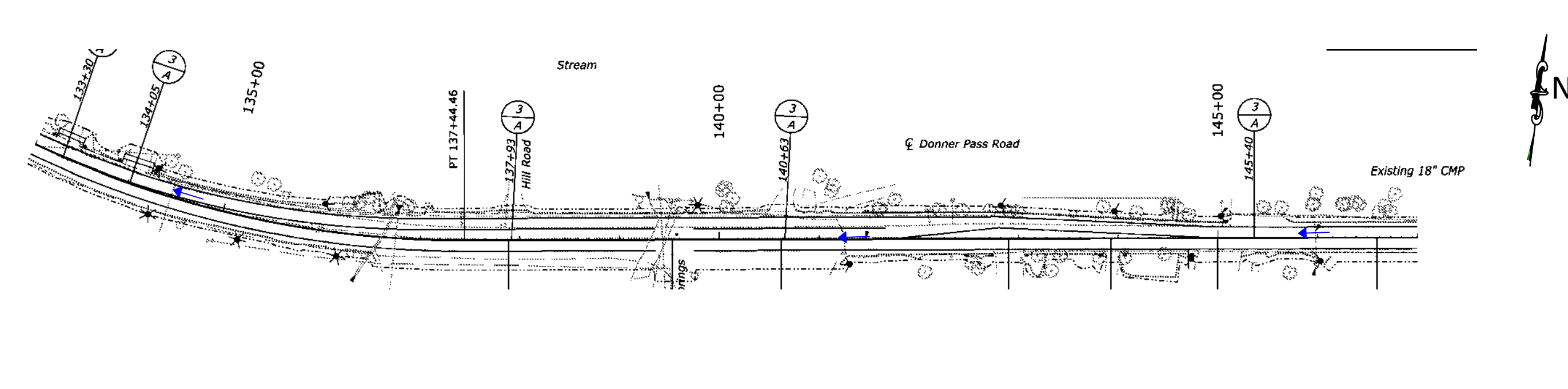

From 133+00 to 147+00

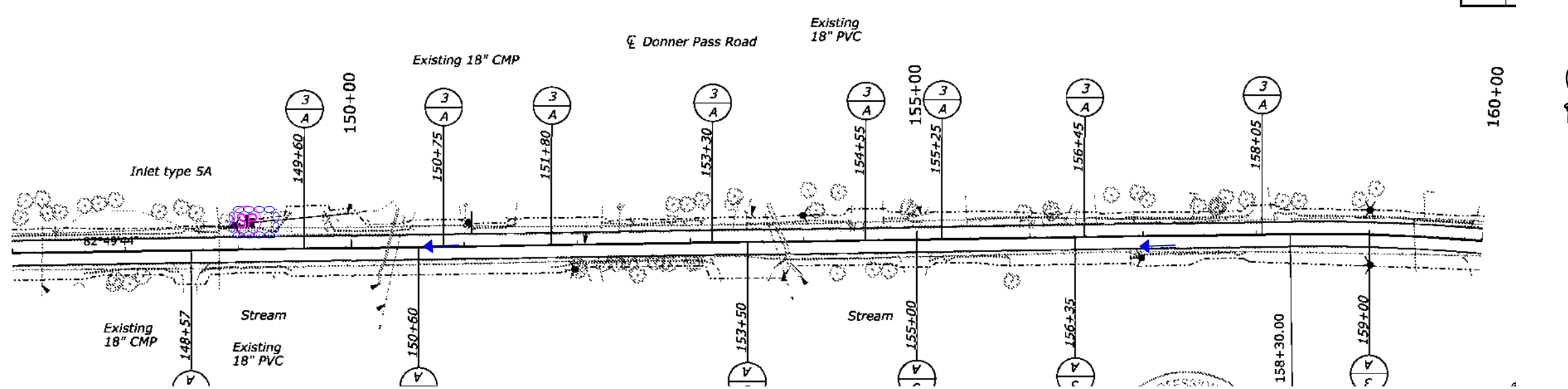

From 147+00 to 160+00

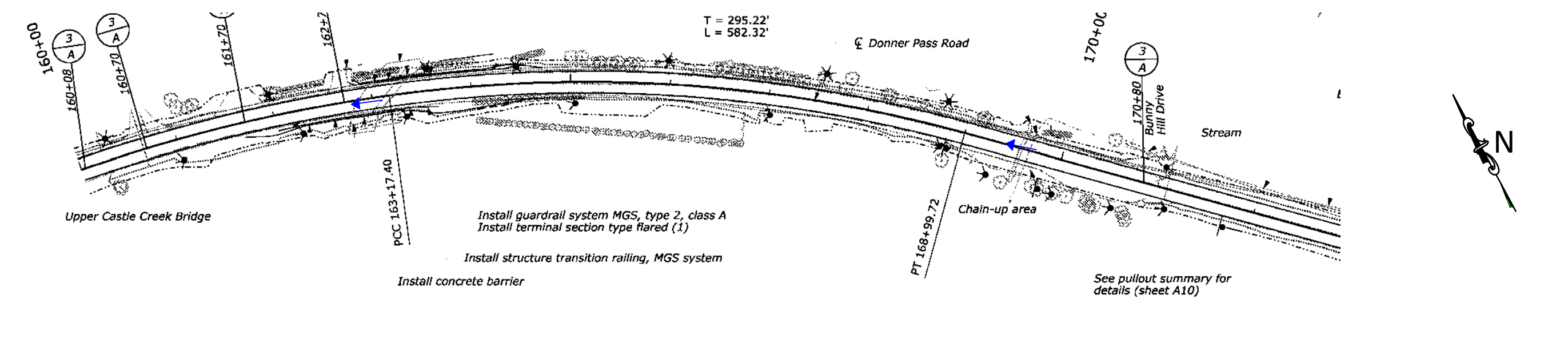

From 160+00 to 173+00

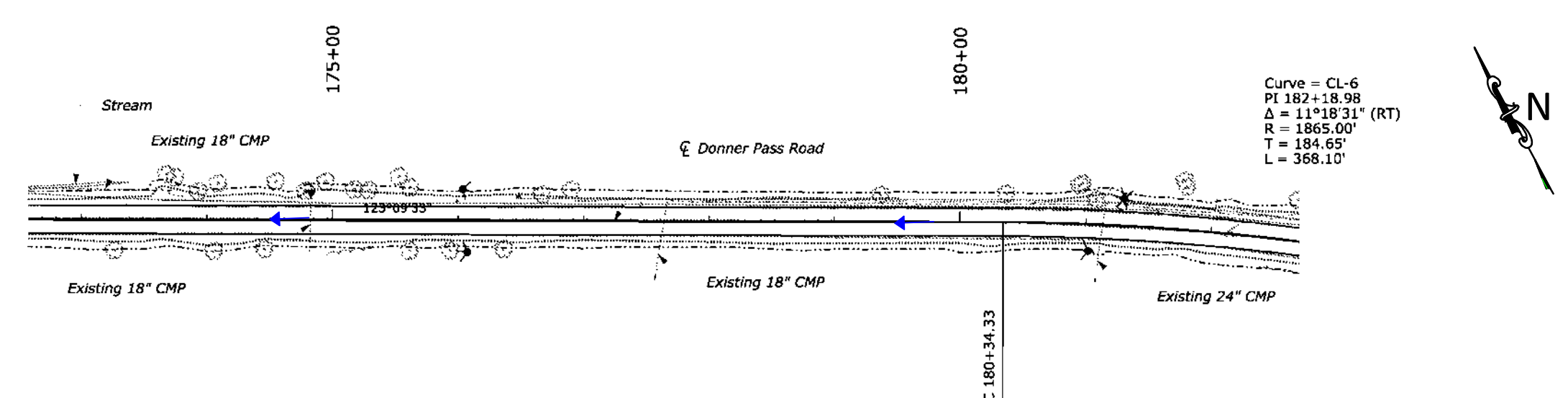

From 173+00 to 182+00

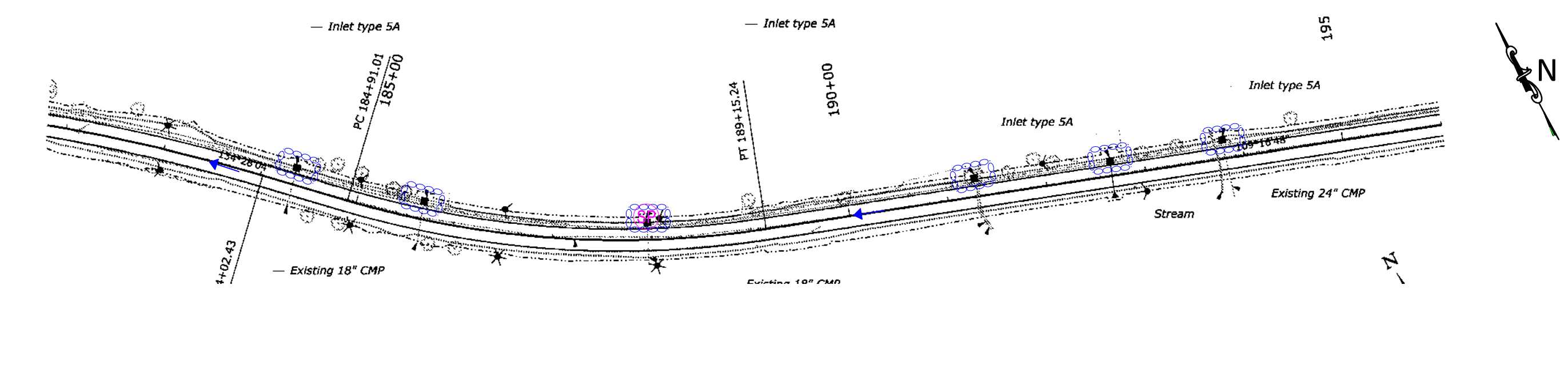

From 182+00 to 196+00

WATER POLLUTION CONTROL DRAWING

NTS



Project:
DONNER PASS ROAD
IMPROVEMENTS

Sheet:
WATER POLLUTION
CONTROL DRAWING

SHEET NO: WP-4

DATE:

11/15/2021

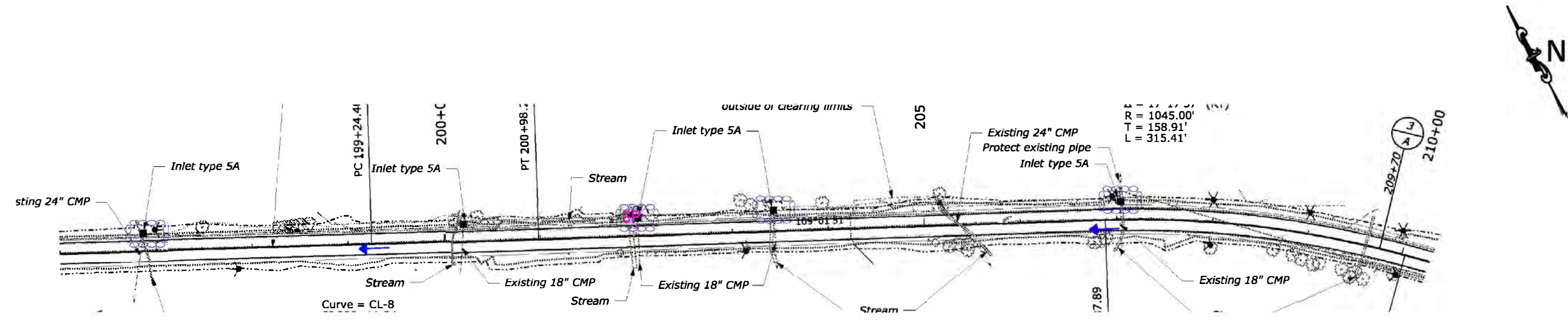

From 196+00 to 210+00

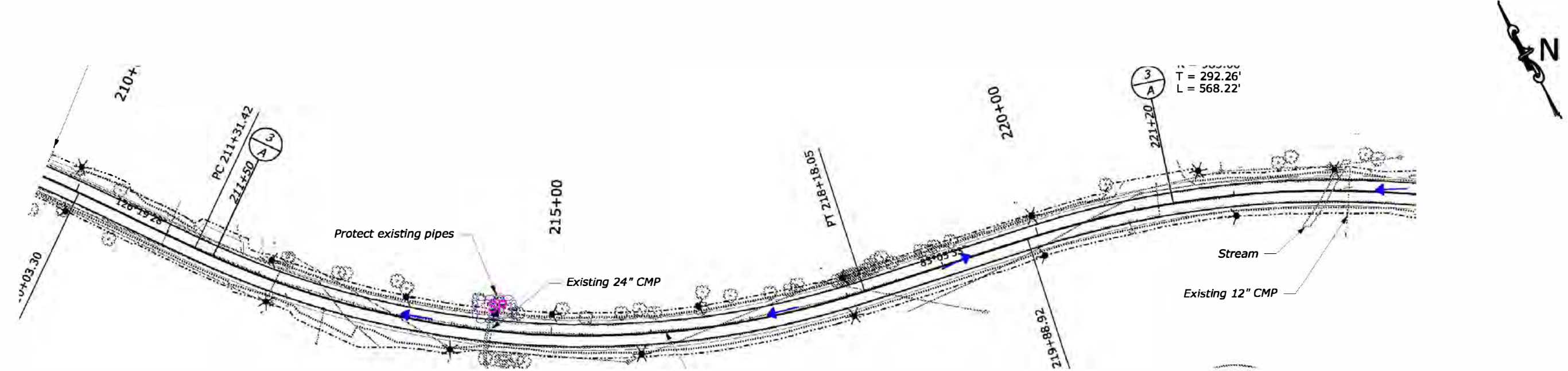

From 210+00 to 224+00

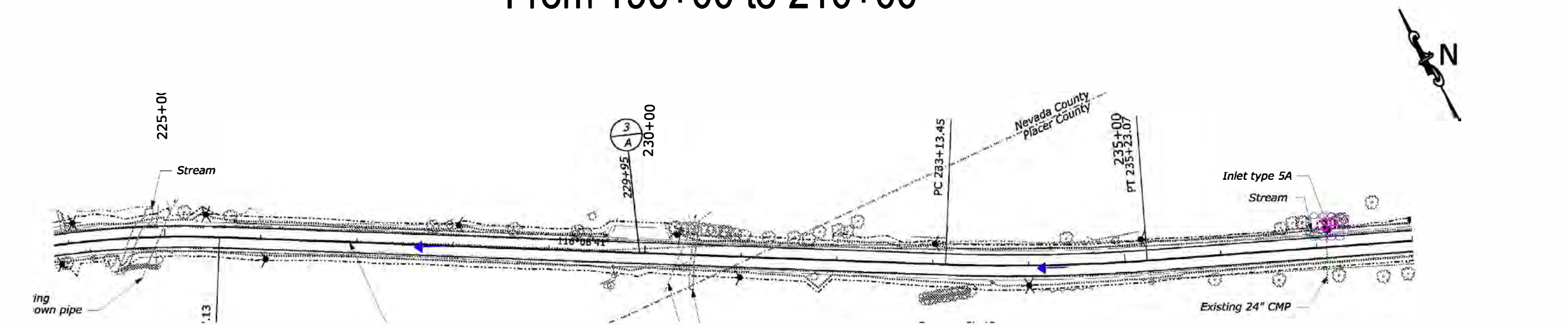

From 224+00 to 238+00

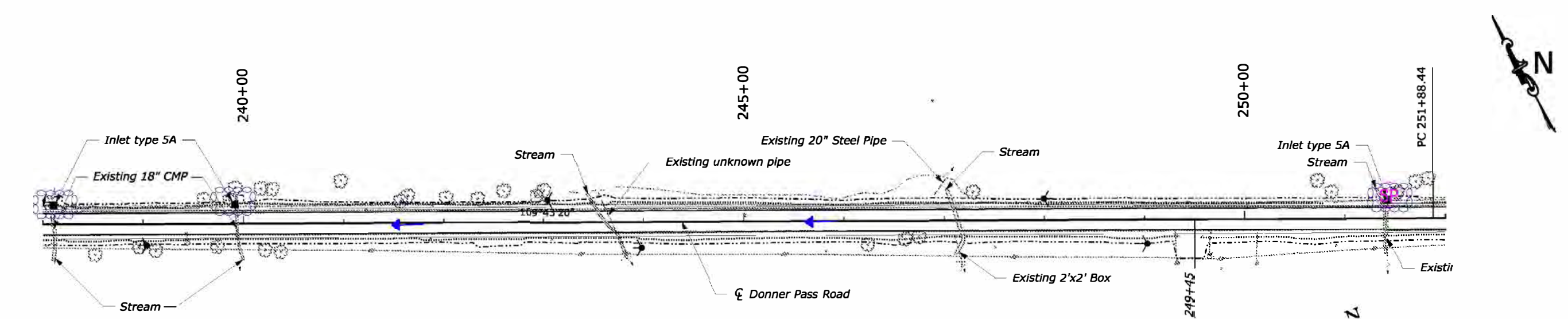

From 238+00 to 252+00

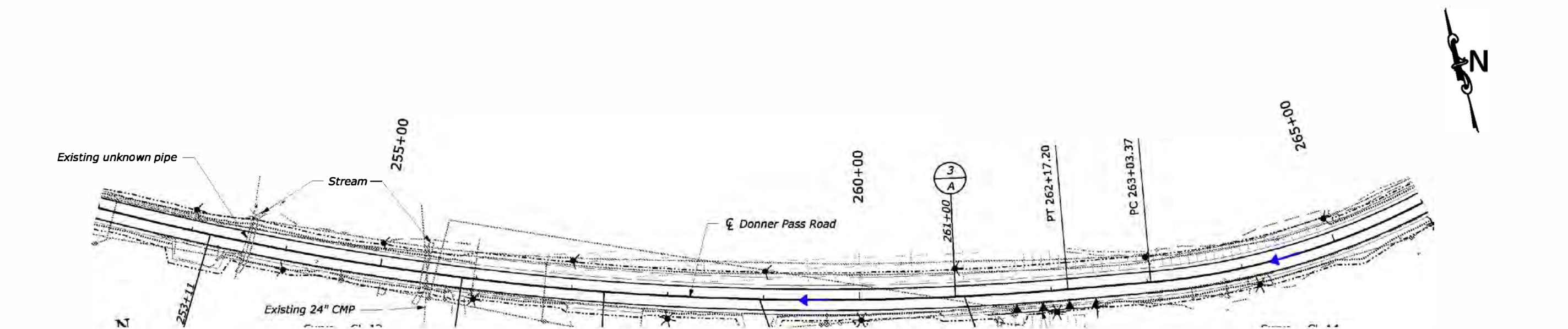

From 252+00 to 266+00

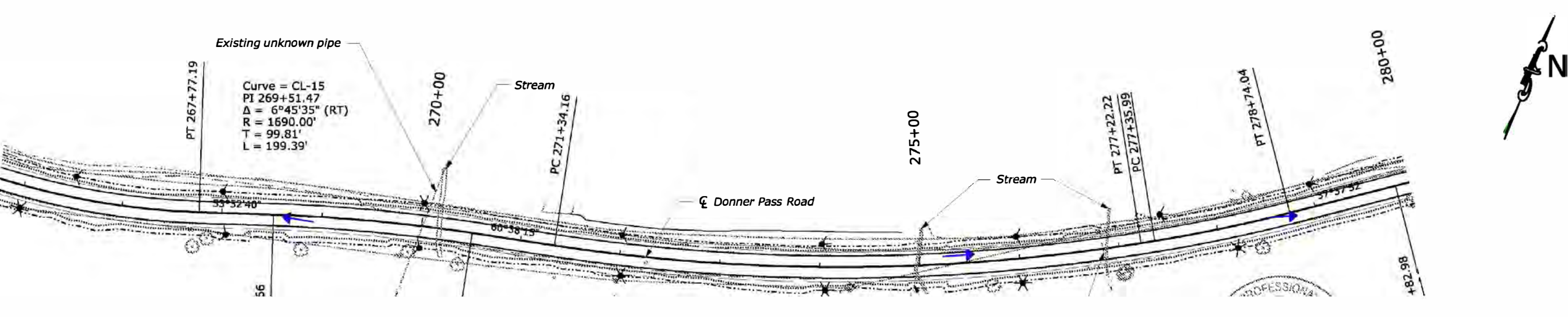

From 266+00 to 280+00

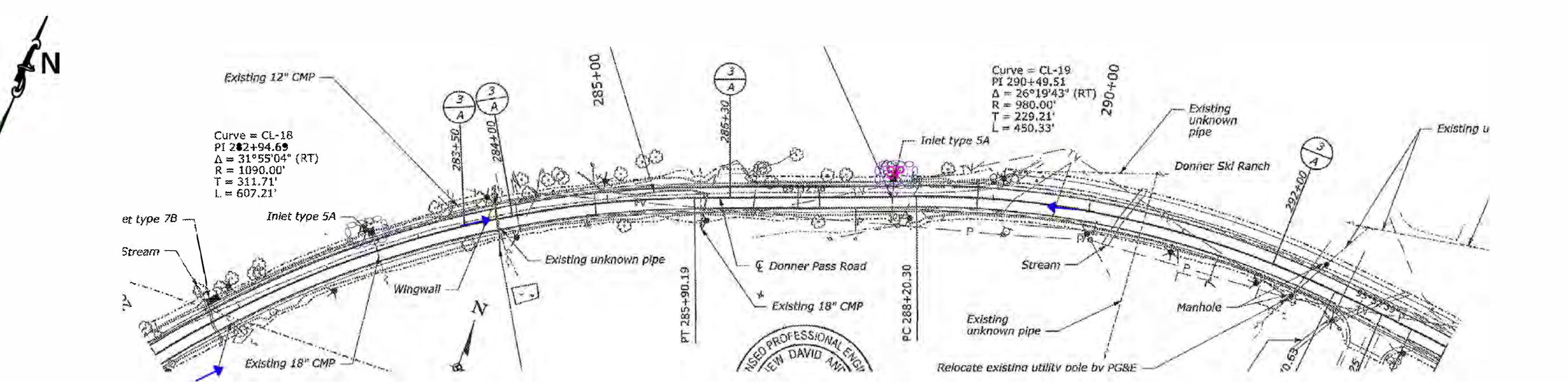

From 280+00 to 294+00

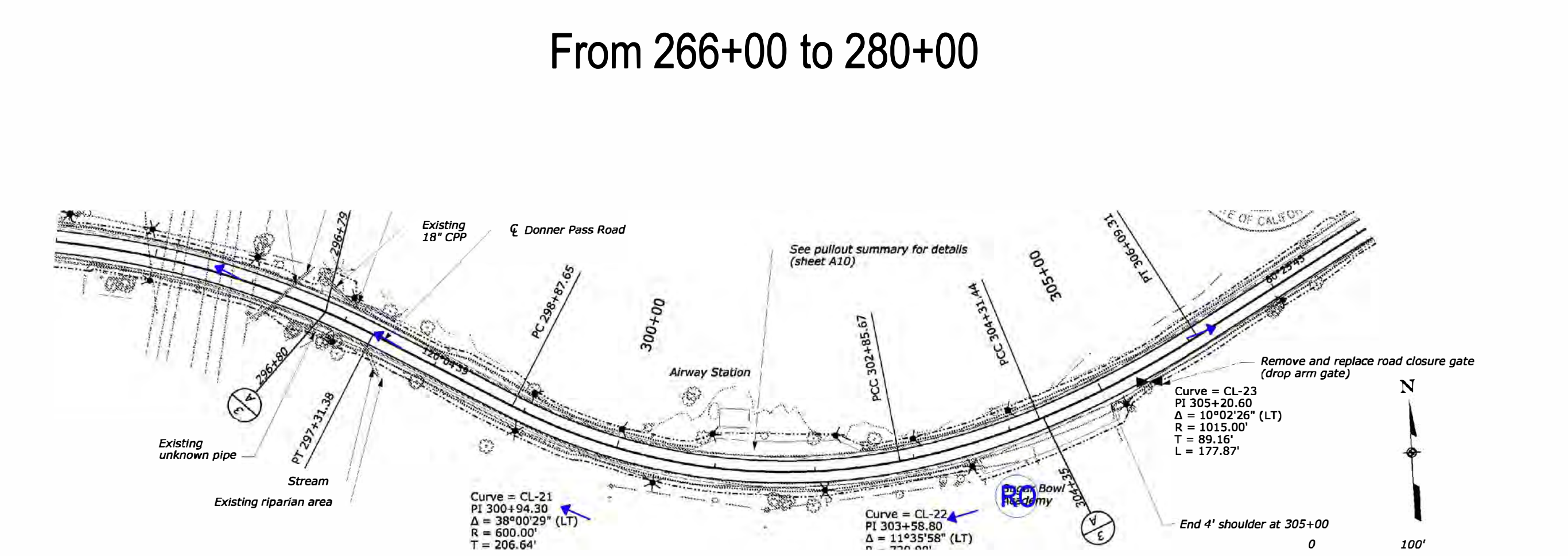

From 294+00 to 308+00

WATER POLLUTION CONTROL DRAWING

NTS



Project:
DONNER PASS ROAD
IMPROVEMENTS

Project:

Sheet:
WATER POLLUTION
CONTROL DRAWING

Sheet:

SHEET NO: WP-5

DATE:

11/15/2021

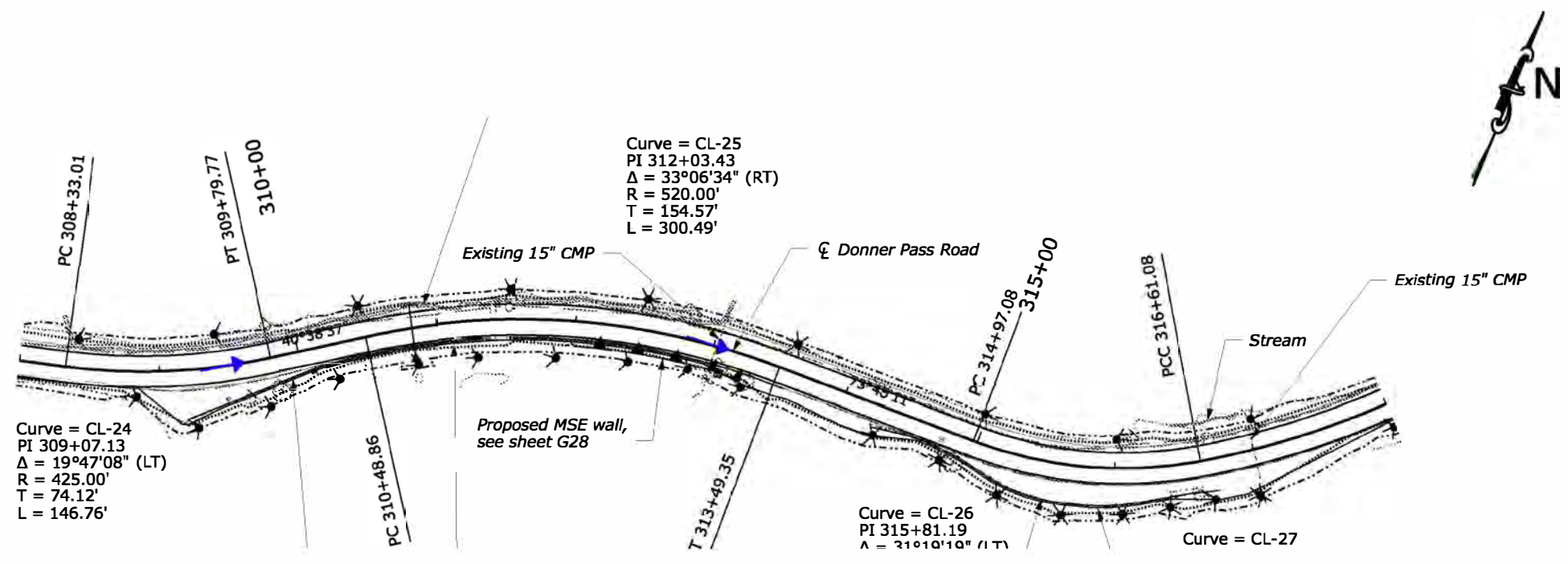

From 308+00 to 318+00

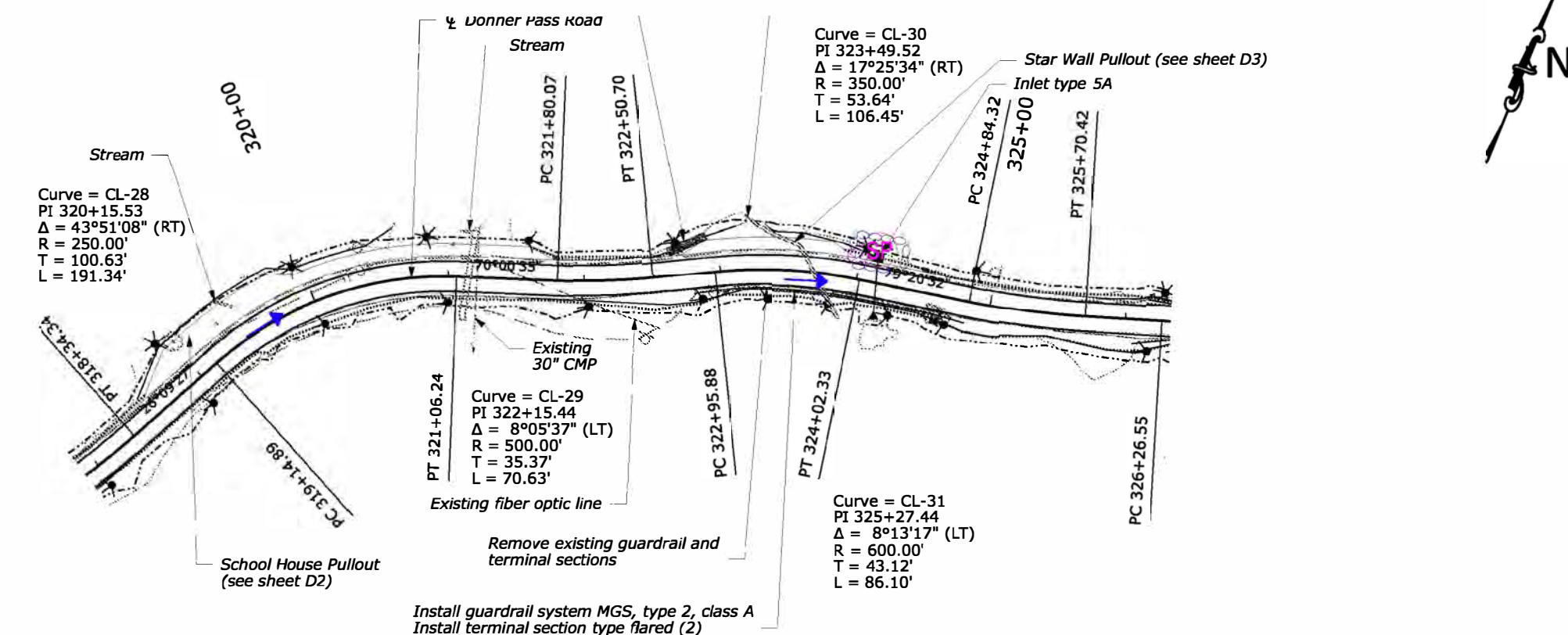

From 318+00 to 326+00

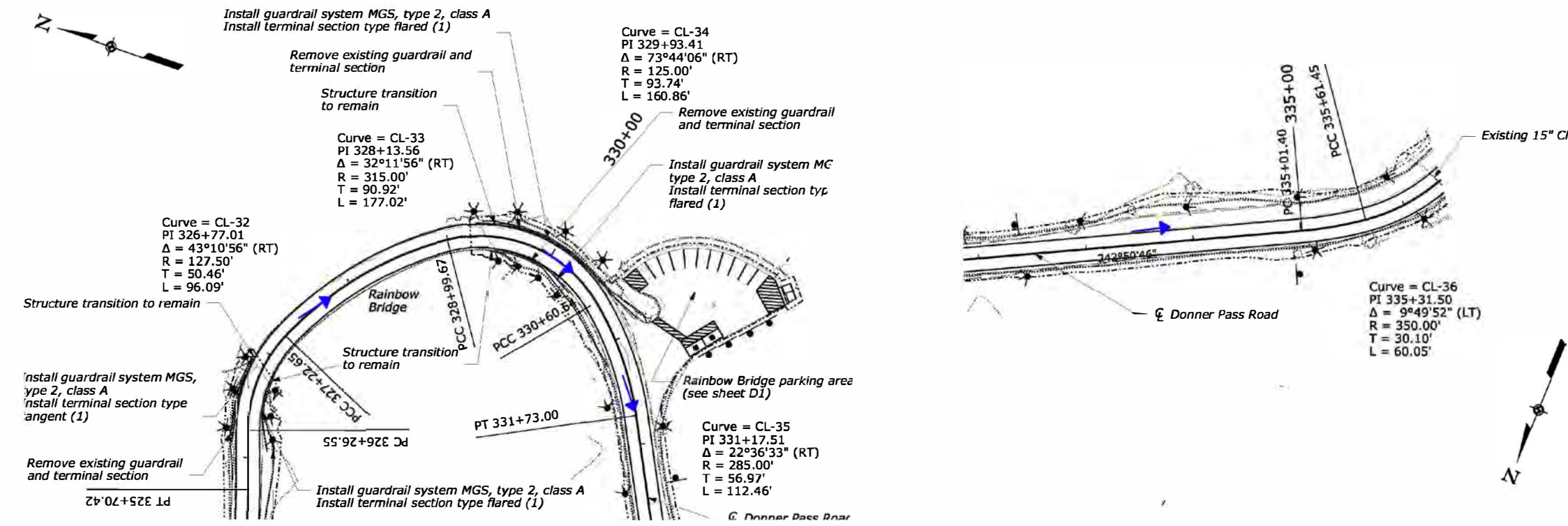

From 326+00 to 336+00

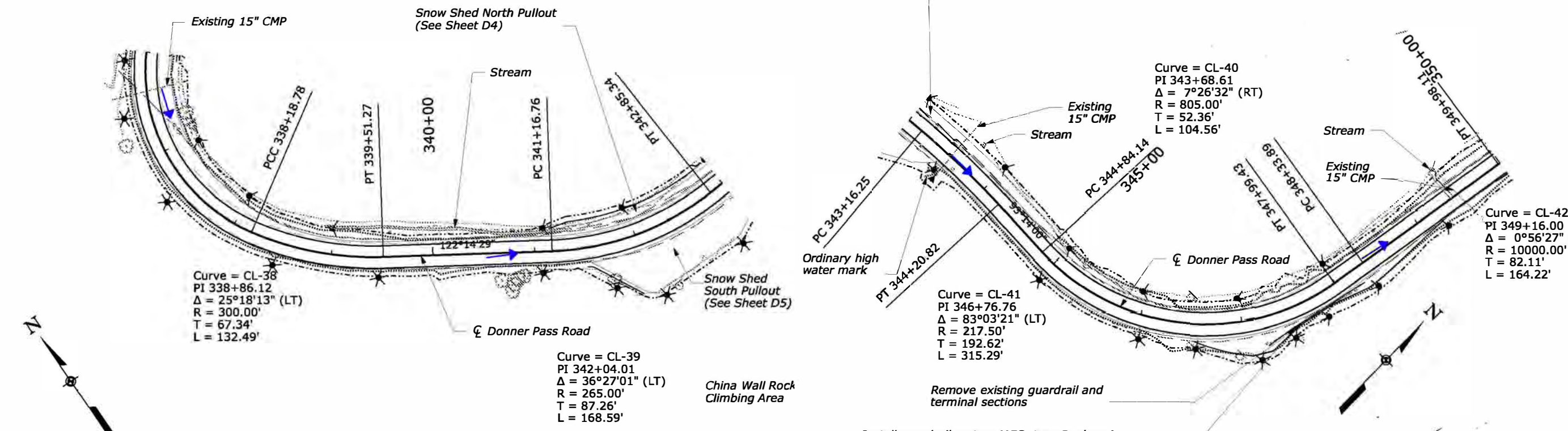

From 336+00 to 350+00

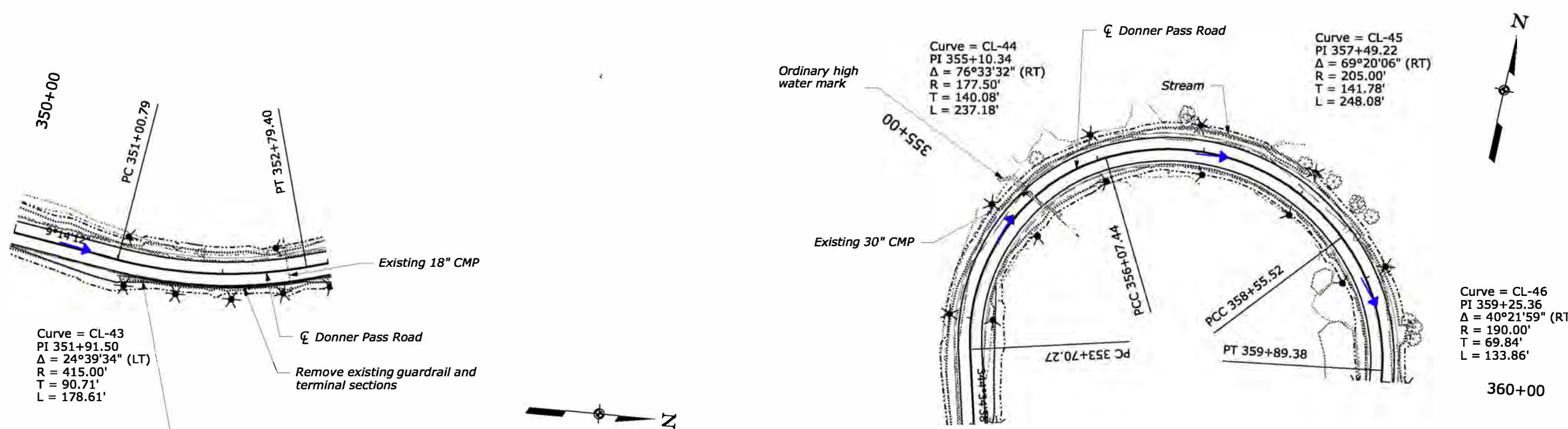

From 350+00 to 360+00

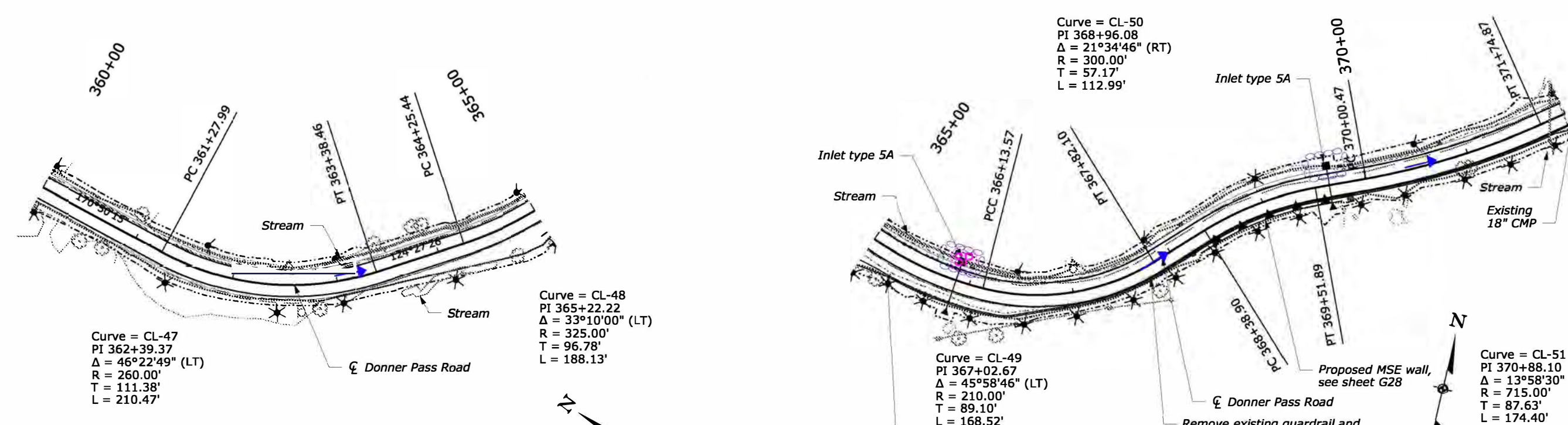

From 360+00 to 372+00

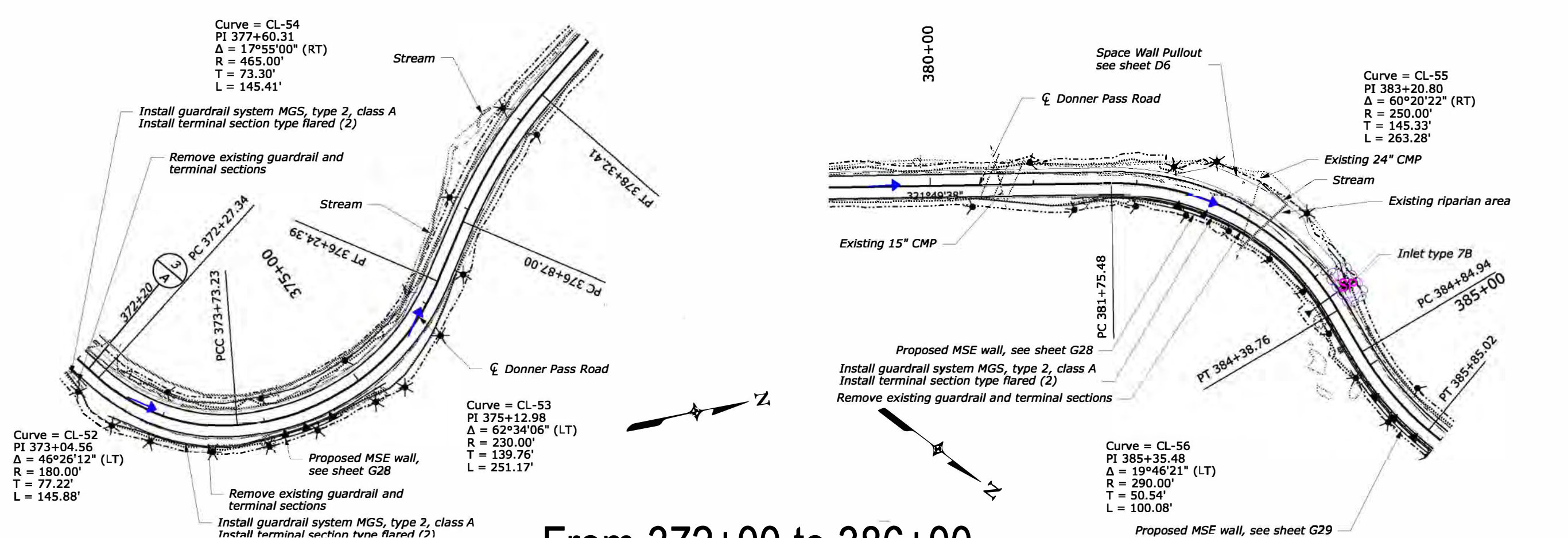

From 372+00 to 386+00

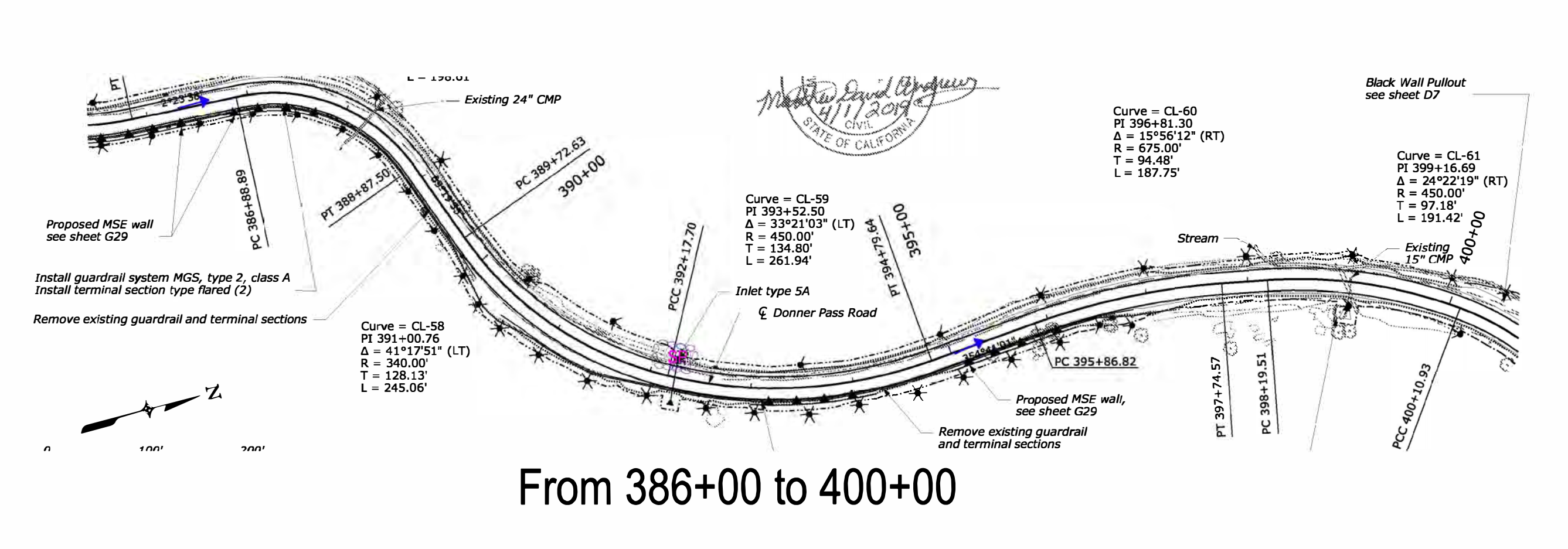

From 386+00 to 400+00

WATER POLLUTION CONTROL DRAWING

NTS



Project:
**DONNER PASS ROAD
IMPROVEMENTS**

Sheet:
**WATER POLLUTION
CONTROL DRAWING**

SHEET NO: WP-6

DATE:

11/15/2021

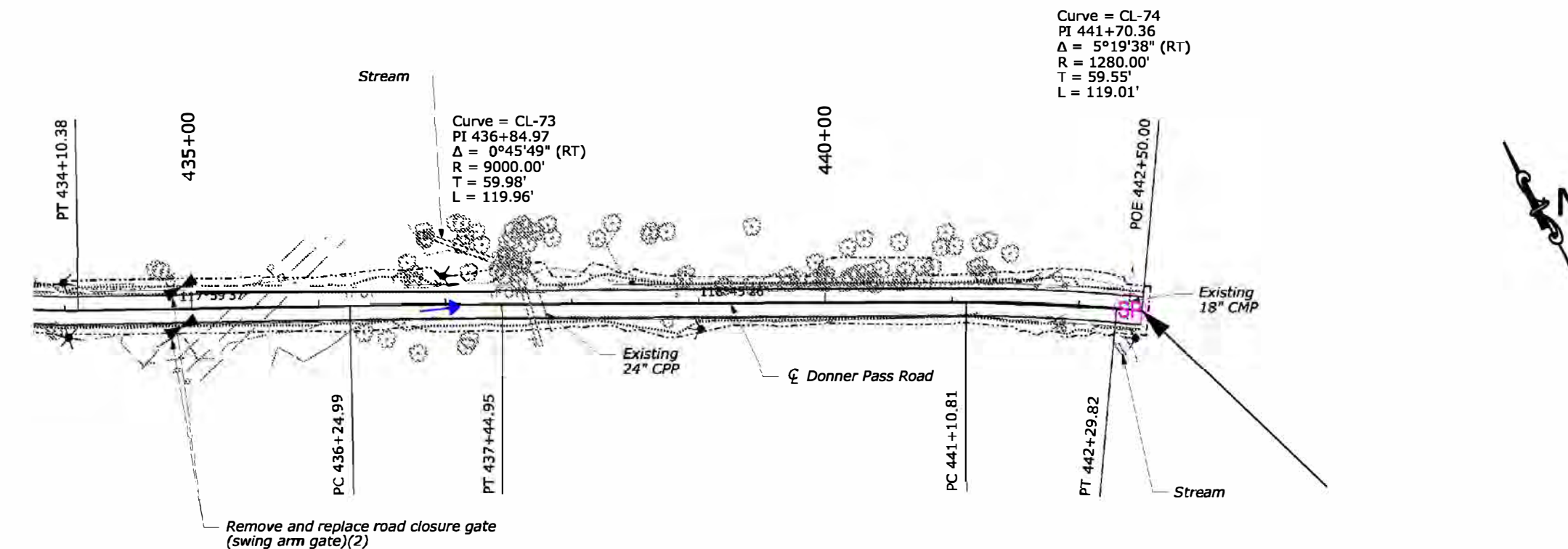
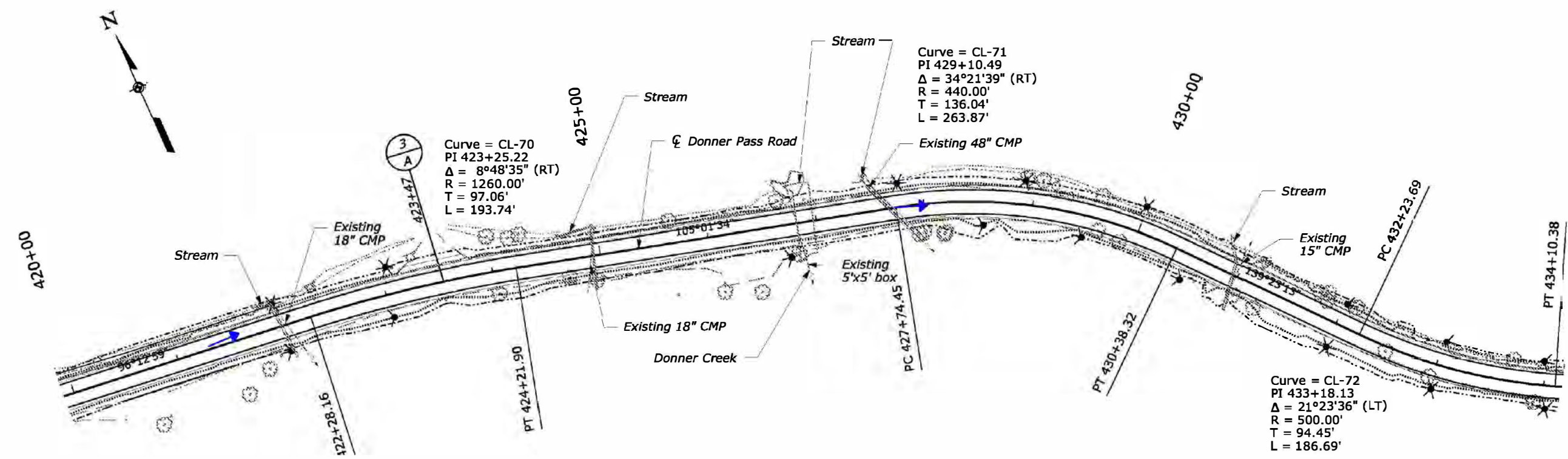
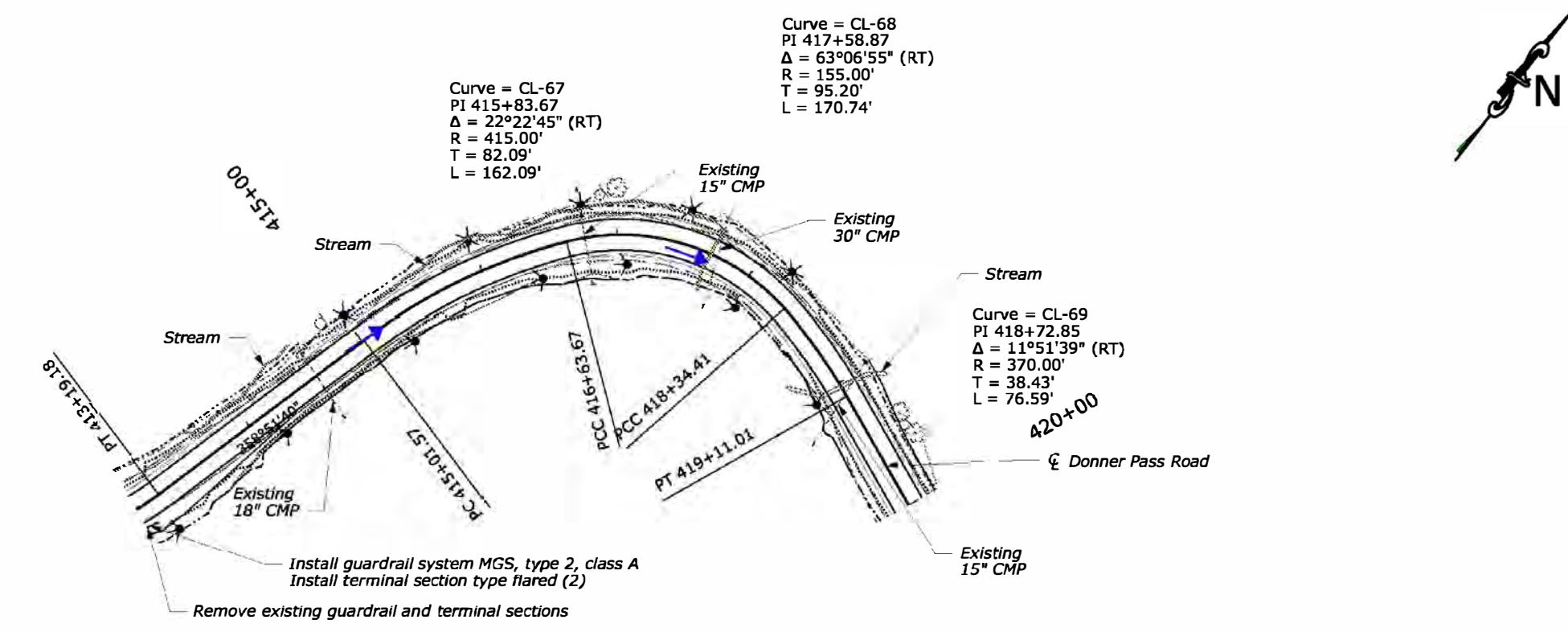
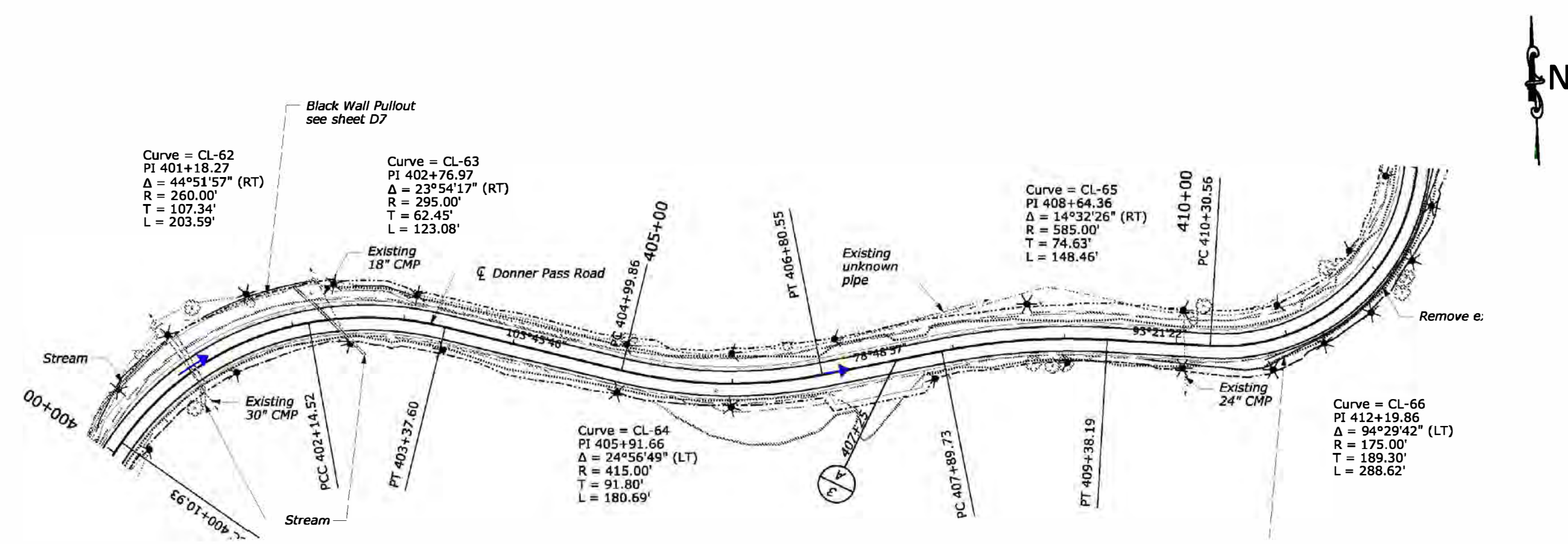

WATER POLLUTION CONTROL DRAWING

NTS

Appendix C: Permit Registration Documents

Permit Registration Documents included in this Appendix

Y/N	Permit Registration Document
	Notice of Intent
	Risk Assessment
	Certification
	Post Construction Water Balance
	Copy of Annual Fee Receipt
	ATS Design Documents
	Site Map, see Appendix B

Appendix D: SWPPP Amendment Certifications

SWPPP Amendment No.

DONNER PASS ROAD IMPROVEMENTS (CA FLAP NEV 40(1))

Project Name:

Project Number:

**Qualified SWPPP Developer’s Certification of the
Stormwater Pollution Prevention Plan Amendment**

“This Stormwater Pollution Prevention Plan and attachments were prepared under my direction to meet the requirements of the California Construction General Permit (SWRCB Order No. 2009-009-DWQ as amended by 2010-0014-DWQ and 2012-00xx-DWQ). I certify that I am a Qualified SWPPP Developer in good standing as of the date signed below.”

QSD’s Signature

Date

QSD Name

QSD Certificate Number

Title and Affiliation

Telephone

Address

Email

=====

Appendix E: Submitted Changes to PRDs

Log of Updated PRDs

The General Permit allows for the reduction or increase of the total acreage covered under the General Permit when a portion of the project is complete and/or conditions for termination of coverage have been met; when ownership of a portion of the project is purchased by a different entity; or when new acreage is added to the project.

Modified PRDs shall be filed electronically within 30 days of a reduction or increase in total disturbed area if a change in permit covered acreage is to be sought. The SWPPP shall be modified appropriately, with revisions and amendments recorded in Appendix C. Updated PRDs submitted electronically via SMARTS can be found in this Appendix.

This appendix includes all of the following updated PRDs (check all that apply):

- Revised Notice of Intent (NOI);

- Revised Site Map;

- Revised Risk Assessment;

- New landowner's information (name, address, phone number, email address); and

- New signed certification statement.

Legally Responsible Person [if organization]

Signature of [Authorized Representative of] Legally Responsible Person or Approved Signatory

Name of [Authorized Representative of] Legally Responsible Person or Approved Signatory

Date

Telephone Number

Appendix F: Construction Schedule

To be added by the contractor.

***Appendix G: Construction Activities, Materials Used,
and Associated Pollutants***

Table G.1 POLLUTANTS ASSOCIATED WITH CONSTRUCTION ACTIVITIES

General Work Activity/ Products With Potential Stormwater Pollutants	Specific Work Activity/Products With Potential Stormwater Pollutants	Pollutant Categories
Adhesives	Adhesives, glues, resins, epoxy synthetics, PVC cement Caulks, sealers, putty, sealing agents and Coal tars (naphtha, pitch)	Oil and Grease, Synthetic Organics ¹
Asphalt paving/curbs	Hot and cold mix asphalt	Oil and Grease
Cleaners	Polishes (metal, ceramic, tile) Etching agents Cleaners, ammonia, lye, caustic sodas, bleaching agents and chromate salts	Metals, Synthetic Organics
Concrete / Masonry	Cement and brick dust Colored chalks Concrete curing compounds Glazing compounds Surfaces cleaners Saw cut slurries Tile cutting	Metals, Synthetic Organics
Framing/Carpentry	Sawdust, particle board dust, and treated woods Saw cut slurries	Metals, Synthetic Organics
Heating, Ventilation, Air Conditioning	Demolition or construction of air condition and heating systems	Metals, Synthetic Organics
Insulation	Demolition or construction involving insulation, venting systems	Metals, Synthetic Organics
Liquid waste	Wash waters Irrigation line testing/flushing	Metals, Synthetic Organics
Painting	Paint thinners, acetone, methyl ethyl ketone, stripper paints, lacquers, varnish, enamels, turpentine, gum spirit, solvents, dyes, stripping pigments and sanding	Metals, Synthetic Organics
Planting / Vegetation Management	Vegetation control (pesticides/herbicides) Planting Plant maintenance Vegetation removal	Nutrients, Metals, Synthetic Organics

Table G.1 POLLUTANTS ASSOCIATED WITH CONSTRUCTION ACTIVITIES

General Work Activity/ Products With Potential Stormwater Pollutants	Specific Work Activity/Products With Potential Stormwater Pollutants	Pollutant Categories
Plumbing	Solder (lead, tin), flux (zinc chloride), pipe fitting Galvanized metal in nails, fences, and electric wiring	Metals, Synthetic Organics
Reservoir/fountains	Chlorinated water	Synthetic Organics
Removal of existing structures	Demolition of asphalt, concrete, masonry, framing, roofing, metal structures.	Metals, Oil and Grease, Synthetic Organics
Sanitary waste	Portable toilets Disturbance of existing sewer lines.	Nutrients
Soil preparation/amendments	Use of soil additives/amendments	Nutrients
Solid waste	Litter, trash and debris Vegetation	Gross Pollutants
Utility line testing and flushing	Hydrostatic test water Pipe flushing	Synthetic Organics
Vehicle and equipment use	Equipment operation Equipment maintenance Equipment washing Equipment fueling	Oil and Grease
¹ Synthetic Organics are defined in Table 1.2 of the CASQA <i>Stormwater BMP Handbook Portal: Construction</i> as adhesives, cleaners, sealants, solvents, etc. These are generally categorized as VOCs or SVOCs.		

***Appendix H: CASQA Stormwater BMP Handbook
Portal: Construction Fact Sheets***

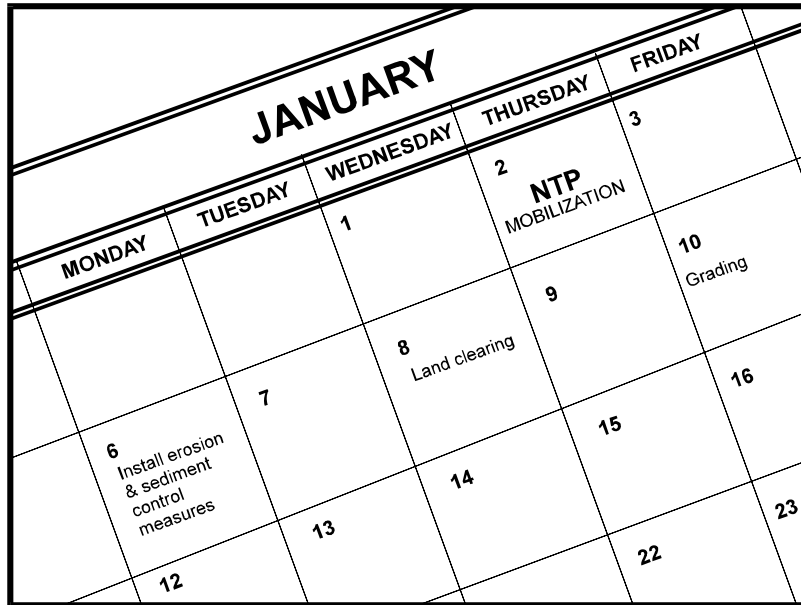

Description and Purpose

Scheduling is the development of a written plan that includes sequencing of construction activities and the implementation of BMPs such as erosion control and sediment control while taking local climate (rainfall, wind, etc.) into consideration. The purpose is to reduce the amount and duration of soil exposed to erosion by wind, rain, runoff, and vehicle tracking, and to perform the construction activities and control practices in accordance with the planned schedule.

Suitable Applications

Proper sequencing of construction activities to reduce erosion potential should be incorporated into the schedule of every construction project especially during rainy season. Use of other, more costly yet less effective, erosion and sediment control BMPs may often be reduced through proper construction sequencing.

Limitations

- Environmental constraints such as nesting season prohibitions reduce the full capabilities of this BMP.

Implementation

- Avoid rainy periods. Schedule major grading operations during dry months when practical. Allow enough time before rainfall begins to stabilize the soil with vegetation or physical means or to install sediment trapping devices.
- Plan the project and develop a schedule showing each phase

Categories

EC	Erosion Control	<input checked="" type="checkbox"/>
SE	Sediment Control	<input checked="" type="checkbox"/>
TC	Tracking Control	<input checked="" type="checkbox"/>
WE	Wind Erosion Control	<input checked="" type="checkbox"/>
NS	Non-Stormwater Management Control	
WM	Waste Management and Materials Pollution Control	

Legend:

- Primary Objective
- Secondary Objective

Targeted Constituents

Sediment	<input checked="" type="checkbox"/>
Nutrients	
Trash	
Metals	
Bacteria	
Oil and Grease	
Organics	

Potential Alternatives

None



of construction. Clearly show how the rainy season relates to soil disturbing and re-stabilization activities. Incorporate the construction schedule into the SWPPP.

- Include on the schedule, details on the rainy season implementation and deployment of:
 - Erosion control BMPs
 - Sediment control BMPs
 - Tracking control BMPs
 - Wind erosion control BMPs
 - Non-stormwater BMPs
 - Waste management and materials pollution control BMPs
- Include dates for activities that may require non-stormwater discharges such as dewatering, sawcutting, grinding, drilling, boring, crushing, blasting, painting, hydro-demolition, mortar mixing, pavement cleaning, etc.
- Work out the sequencing and timetable for the start and completion of each item such as site clearing and grubbing, grading, excavation, paving, foundation pouring utilities installation, etc., to minimize the active construction area during the rainy season.
 - Sequence trenching activities so that most open portions are closed before new trenching begins.
 - Incorporate staged seeding and re-vegetation of graded slopes as work progresses.
 - Schedule establishment of permanent vegetation during appropriate planting time for specified vegetation.
- Non-active areas should be stabilized as soon as practical after the cessation of soil disturbing activities or one day prior to the onset of precipitation.
- Monitor the weather forecast for rainfall.
- When rainfall is predicted, adjust the construction schedule to allow the implementation of soil stabilization and sediment treatment controls on all disturbed areas prior to the onset of rain.
- Be prepared year round to deploy erosion control and sediment control BMPs. Erosion may be caused during dry seasons by un-seasonal rainfall, wind, and vehicle tracking. Keep the site stabilized year round, and retain and maintain rainy season sediment trapping devices in operational condition.
- Apply permanent erosion control to areas deemed substantially complete during the project's defined seeding window.

Costs

Construction scheduling to reduce erosion may increase other construction costs due to reduced economies of scale in performing site grading. The cost effectiveness of scheduling techniques should be compared with the other less effective erosion and sedimentation controls to achieve a cost effective balance.

Inspection and Maintenance

- Verify that work is progressing in accordance with the schedule. If progress deviates, take corrective actions.
- Amend the schedule when changes are warranted.
- Amend the schedule prior to the rainy season to show updated information on the deployment and implementation of construction site BMPs.

References

Stormwater Quality Handbooks Construction Site Best Management Practices (BMPs) Manual, State of California Department of Transportation (Caltrans), November 2000.

Stormwater Management for Construction Activities Developing Pollution Prevention Plans and Best Management Practices (EPA 832-R-92-005), U.S. Environmental Protection Agency, Office of Water, September 1992.

Preservation Of Existing Vegetation EC-2

contractor, and design staff.

- Limited opportunities for use when project plans do not incorporate existing vegetation into the site design.
- For sites with diverse topography, it is often difficult and expensive to save existing trees while grading the site satisfactory for the planned development.

Implementation

The best way to prevent erosion is to not disturb the land. In order to reduce the impacts of new development and redevelopment, projects may be designed to avoid disturbing land in sensitive areas of the site (e.g., natural watercourses, steep slopes), and to incorporate unique or desirable existing vegetation into the site's landscaping plan. Clearly marking and leaving a buffer area around these unique areas during construction will help to preserve these areas as well as take advantage of natural erosion prevention and sediment trapping.

Existing vegetation to be preserved on the site must be protected from mechanical and other injury while the land is being developed. The purpose of protecting existing vegetation is to ensure the survival of desirable vegetation for shade, beautification, and erosion control. Mature vegetation has extensive root systems that help to hold soil in place, thus reducing erosion. In addition, vegetation helps keep soil from drying rapidly and becoming susceptible to erosion. To effectively save existing vegetation, no disturbances of any kind should be allowed within a defined area around the vegetation. For trees, no construction activity should occur within the drip line of the tree.

Timing

- Provide for preservation of existing vegetation prior to the commencement of clearing and grubbing operations or other soil disturbing activities in areas where no construction activity is planned or will occur at a later date.

Design and Layout

- Mark areas to be preserved with temporary fencing. Include sufficient setback to protect roots.
 - Orange colored plastic mesh fencing works well.
 - Use appropriate fence posts and adequate post spacing and depth to completely support the fence in an upright position.
- Locate temporary roadways, stockpiles, and layout areas to avoid stands of trees, shrubs, and grass.
- Consider the impact of grade changes to existing vegetation and the root zone.
- Maintain existing irrigation systems where feasible. Temporary irrigation may be required.
- Instruct employees and subcontractors to honor protective devices. Prohibit heavy equipment, vehicular traffic, or storage of construction materials within the protected area.

Preservation Of Existing Vegetation EC-2

Costs

There is little cost associated with preserving existing vegetation if properly planned during the project design, and these costs may be offset by aesthetic benefits that enhance property values. During construction, the cost for preserving existing vegetation will likely be less than the cost of applying erosion and sediment controls to the disturbed area. Replacing vegetation inadvertently destroyed during construction can be extremely expensive, sometimes in excess of \$10,000 per tree.

Inspection and Maintenance

During construction, the limits of disturbance should remain clearly marked at all times. Irrigation or maintenance of existing vegetation should be described in the landscaping plan. If damage to protected trees still occurs, maintenance guidelines described below should be followed:

- Verify that protective measures remain in place. Restore damaged protection measures immediately.
- Serious tree injuries shall be attended to by an arborist.
- Damage to the crown, trunk, or root system of a retained tree shall be repaired immediately.
- Trench as far from tree trunks as possible, usually outside of the tree drip line or canopy. Curve trenches around trees to avoid large roots or root concentrations. If roots are encountered, consider tunneling under them. When trenching or tunneling near or under trees to be retained, place tunnels at least 18 in. below the ground surface, and not below the tree center to minimize impact on the roots.
- Do not leave tree roots exposed to air. Cover exposed roots with soil as soon as possible. If soil covering is not practical, protect exposed roots with wet burlap or peat moss until the tunnel or trench is ready for backfill.
- Cleanly remove the ends of damaged roots with a smooth cut.
- Fill trenches and tunnels as soon as possible. Careful filling and tamping will eliminate air spaces in the soil, which can damage roots.
- If bark damage occurs, cut back all loosened bark into the undamaged area, with the cut tapered at the top and bottom and drainage provided at the base of the wood. Limit cutting the undamaged area as much as possible.
- Aerate soil that has been compacted over a trees root zone by punching holes 12 in. deep with an iron bar, and moving the bar back and forth until the soil is loosened. Place holes 18 in. apart throughout the area of compacted soil under the tree crown.
- Fertilization
 - Fertilize stressed or damaged broadleaf trees to aid recovery.
 - Fertilize trees in the late fall or early spring.

Preservation Of Existing Vegetation EC-2

- Apply fertilizer to the soil over the feeder roots and in accordance with label instructions, but never closer than 3 ft to the trunk. Increase the fertilized area by one-fourth of the crown area for conifers that have extended root systems.
- Retain protective measures until all other construction activity is complete to avoid damage during site cleanup and stabilization.

References

County of Sacramento Tree Preservation Ordinance, September 1981.

Stormwater Quality Handbooks Construction Site Best Management Practices (BMPs) Manual, State of California Department of Transportation (Caltrans), November 2000.

Stormwater Management of the Puget Sound Basin, Technical Manual, Publication #91-75, Washington State Department of Ecology, February 1992.

Water Quality Management Plan for The Lake Tahoe Region, Volume II, Handbook of Management Practices, Tahoe Regional Planning Agency, November 1988.

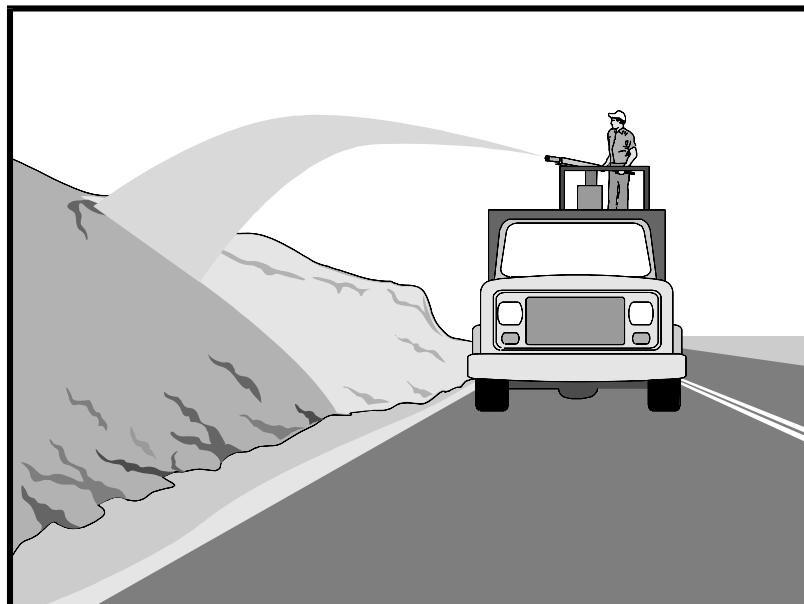

Description and Purpose

Hydraulic Mulch consists of various types of fibrous materials mixed with water and sprayed onto the soil surface in slurry form to provide a layer of temporary protection from wind and water erosion.

Suitable Applications

Hydraulic mulch as a temporary, stand alone, erosion control BMP is suitable for disturbed areas that require temporary protection from wind and water erosion until permanent soil stabilization activities commence. Examples include:

- Rough-graded areas that will remain inactive for longer than permit-required thresholds (e.g., 14 days) or otherwise require stabilization to minimize erosion or prevent sediment discharges.
- Soil stockpiles.
- Slopes with exposed soil between existing vegetation such as trees or shrubs.
- Slopes planted with live, container-grown vegetation or plugs.
- Slopes burned by wildfire.

Hydraulic mulch can also be applied to augment other erosion control BMPs such as:

Categories

EC	Erosion Control	<input checked="" type="checkbox"/>
SE	Sediment Control	
TC	Tracking Control	
WE	Wind Erosion Control	<input checked="" type="checkbox"/>
NS	Non-Stormwater Management Control	
WM	Waste Management and Materials Pollution Control	

Legend:

- Primary Category**
- Secondary Category**

Targeted Constituents

Sediment	<input checked="" type="checkbox"/>
Nutrients	
Trash	
Metals	
Bacteria	
Oil and Grease	
Organics	

Potential Alternatives

- EC-4 Hydroseeding
- EC-5 Soil Binders
- EC-6 Straw Mulch
- EC-7 Geotextiles and Mats
- EC-8 Wood Mulching
- EC-14 Compost Blanket
- EC-16 Non-Vegetative Stabilization



- In conjunction with straw mulch (see EC-6 Straw Mulch) where the rate of hydraulic mulch is reduced to 100-500 lbs per acre and the slurry is applied over the straw as a tackifying agent to hold the straw in place.
- Supplemental application of soil amendments, such as fertilizer, lime, gypsum, soil bio-stimulants or compost.

Limitations

In general, hydraulic mulch is not limited by slope length, gradient or soil type. However, the following limitations typically apply:

- Most hydraulic mulch applications, particularly bonded fiber matrices (BFMs), require at least 24 hours to dry before rainfall occurs.
- Temporary applications (i.e., without a vegetative component) may require a second application in order to remain effective for an entire rainy season.
- Treatment areas must be accessible to hydraulic mulching equipment.
- Availability of water sources in remote areas for mixing and application.
- As a stand-alone temporary BMP, hydraulic mulches may need to be re-applied to maintain their erosion control effectiveness, typically after 6-12 months depending on the type of mulch used.
- Availability of hydraulic mulching equipment may be limited just prior to the rainy season and prior to storms due to high demand.
- Cellulose fiber mulches alone may not perform well on steep slopes or in course soils.

Implementation

- Where feasible, it is preferable to prepare soil surfaces prior to application by roughening embankments and fill areas with a crimping or punching type roller or by track walking.
- The majority of hydraulic mulch applications do not necessarily require surface/soil preparation (See EC-15 Soil Preparation) although in almost every case where re-vegetation is included as part of the practice, soil preparation can be beneficial. One of the advantages of hydraulic mulch over other erosion control methods is that it can be applied in areas where soil preparation is precluded by site conditions, such as steep slopes, rocky soils, or inaccessibility.
- Avoid mulch over spray onto roads, sidewalks, drainage channels, existing vegetation, etc.
- Hydraulic mulching is generally performed utilizing specialized machines that have a large water-holding/mixing tank and some form of mechanical agitation or other recirculation method to keep water, mulch and soil amendments in suspension. The mixed hydraulic slurry can be applied from a tower sprayer on top of the machine or by extending a hose to areas remote from the machine.

- Where possible apply hydraulic mulch from multiple directions to adequately cover the soil. Application from a single direction can result in shadowing, uneven coverage and failure of the BMP.
- Hydraulic mulch can also include a vegetative component, such as seed, rhizomes, or stolons (see EC-4 Hydraulic Seed).
- Typical hydraulic mulch application rates range from 2,000 pounds per acre for standard mulches (SMs) to 3,500 pounds per acre for BFMs. However, the required amount of hydraulic mulch to provide adequate coverage of exposed topsoil may appear to exceed the standard rates when the roughness of the soil surface is changed due to soil preparation methods (see EC-15 Soil Preparation) or by slope gradient.
- Other factors such as existing soil moisture and soil texture can have a profound effect on the amount of hydraulic mulch required (i.e. application rate) applied to achieve an erosion-resistant covering.
- Avoid use of mulch without a tackifier component, especially on slopes.
- Mulches used in the hydraulic mulch slurry can include:
 - Cellulose fiber
 - Thermally-processed wood fibers
 - Cotton
 - Synthetics
 - Compost (see EC-14, Compost Blanket)
- Additional guidance on the comparison and selection of temporary slope stabilization methods is provided in Appendix F of the Handbook.

Categories of Hydraulic Mulches

Standard Hydraulic Mulch (SM)

Standard hydraulic mulches are generally applied at a rate of 2,000 pounds per acre and are manufactured containing around 5% tackifier (i.e. soil binder), usually a plant-derived guar or psyllium type. Most standard mulches are green in color derived from food-color based dyes.

Hydraulic Matrices (HM) and Stabilized Fiber Matrices (SFM)

Hydraulic matrices and stabilized fiber matrices are slurries which contain increased levels of tackifiers/soil binders; usually 10% or more by weight. HMs and SFMs have improved performance compared to a standard hydraulic mulch (SM) because of the additional percentage of tackifier and because of their higher application rates, typically 2,500 – 4,000 pounds per acre. Hydraulic matrices can include a mixture of fibers, for example, a 50/50 blend of paper and wood fiber. In the case of an SFM, the tackifier/soil binder is specified as a polyacrylamide (PAM).

Bonded Fiber Matrix (BFM)

Bonded fiber matrices (BFMs) are hydraulically-applied systems of fibers, adhesives (typically guar based) and chemical cross-links. Upon drying, the slurry forms an erosion-resistant blanket that prevents soil erosion and promotes vegetation establishment. The cross-linked adhesive in the BFM should be biodegradable and should not dissolve or disperse upon re-wetting. BFMs are typically applied at rates from 3,000 to 4,000 lbs/acre based on the manufacturer’s recommendation. BFMs should not be applied immediately before, during or immediately after rainfall or if the soil is saturated. Depending on the product, BFMs typically require 12 to 24 hours to dry and become effective.

Mechanically-Bonded Fiber Matrices (MBFM)

Mechanically-bonded fiber matrices (MBFMs) are hydraulically applied systems similar to BFM that use crimped synthetic fibers and PAM and are typically applied to a slope at a higher application rate than a standard BFM.

Hydraulic Compost Matrix (HCM)

Hydraulic compost matrix (HCM) is a field-derived practice whereby finely graded or sifted compost is introduced into the hydraulic mulch slurry. A guar-type tackifier can be added for steeper slope applications as well as any specified seed mixtures. A HCM can help to accelerate seed germination and growth. HCMs are particularly useful as an in-fill for three-dimensional re-vegetation geocomposites, such as turf reinforcement mats (TRM) (see EC-7 Geotextiles and Mats).

Costs

Average installed costs for hydraulic mulch categories are provided in Table 1, below.

**Table 1
HYDRAULIC MULCH BMPs
INSTALLED COSTS**

BMP	Installed Cost/Acre
Standard Hydraulic Mulching (SM)	\$1,700 - \$3,600 per acre
Hydraulic Matrices (HM) and Stabilized Fiber Matrices	
Guar-based	\$2,000 - \$4,000 per acre
PAM-based	\$2,500 - \$5,610 per acre
Bonded Fiber Matrix (BFM)	\$3,900 - \$6,900 per acre
Mechanically Bonded Fiber Matrix (MBFM)	\$4,500 - \$6,000 per acre
Hydraulic Compost Matrix (HCM)	\$3,000 - \$3,500 per acre

Source: Caltrans Soil Stabilization BMP Research for Erosion and Sediment Controls, July 2007

Inspection and Maintenance

- Maintain an unbroken, temporary mulched ground cover throughout the period of construction when the soils are not being reworked.
- BMPs must be inspected in accordance with General Permit requirements for the associated project type and risk level. It is recommended that at a minimum, BMPs be inspected

weekly, prior to forecasted rain events, daily during extended rain events, and after the conclusion of rain events.

- Areas where erosion is evident should be repaired and BMPs re-applied as soon as possible. Care should be exercised to minimize the damage to protected areas while making repairs, as any area damaged will require re-application of BMPs.
- Compare the number of bags or weight of applied mulch to the area treated to determine actual application rates and compliance with specifications.

References

Soil Stabilization BMP Research for Erosion and Sediment Controls: Cost Survey Technical Memorandum, State of California Department of Transportation (Caltrans), July 2007.

Controlling Erosion of Construction Sites, Agricultural Information #347, U.S. Department of Agriculture (USDA), Natural Resources Conservation Service (NRCS) (formerly Soil Conservation Service – SCS).

Guides for Erosion and Sediment Control in California, USDA Soils Conservation Service, January 1991.

Manual of Standards of Erosion and Sediment Control Measures, Association of Bay Area Governments, May 1995.

Sedimentation and Erosion Control, An Inventory of Current Practices Draft, US EPA, April 1990.

Soil Erosion by Water, Agriculture Information Bulletin #513, U.S. Department of Agriculture, Soil Conservation Service.

Stormwater Quality Handbooks Construction Site Best Management Practices (BMPs) Manual, State of California Department of Transportation (Caltrans), March 2003.

Guidance Document: Soil Stabilization for Temporary Slopes, State of California Department of Transportation (Caltrans), November 1999

Stormwater Management of the Puget Sound Basin, Technical Manual, Publication #91-75, Washington State Department of Ecology, February 1992.

Water Quality Management Plan for the Lake Tahoe Region, Volume II, Handbook of Management Practices, Tahoe Regional Planning Agency, November 1988.

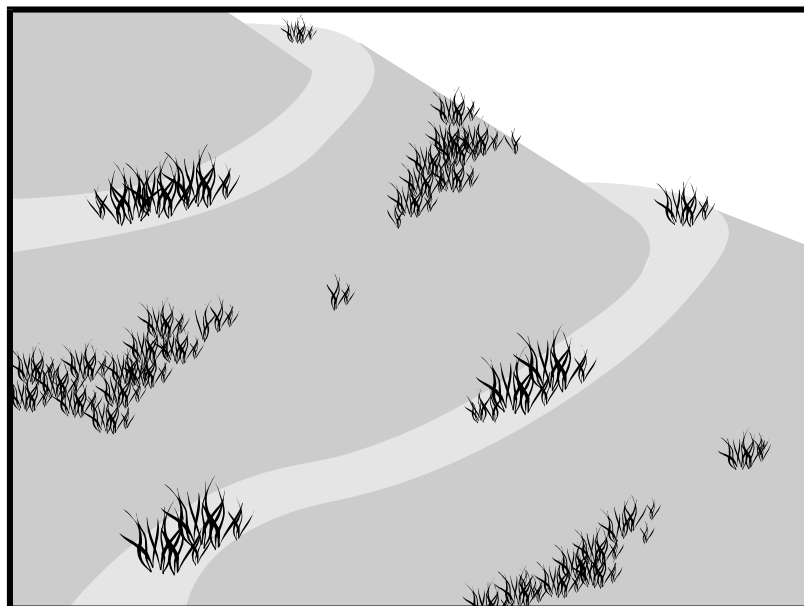

Description and Purpose

Hydroseeding typically consists of applying a mixture of a hydraulic mulch, seed, fertilizer, and stabilizing emulsion with a hydraulic mulcher, to temporarily protect exposed soils from erosion by water and wind. Hydraulic seeding, or hydroseeding, is simply the method by which temporary or permanent seed is applied to the soil surface.

Suitable Applications

Hydroseeding is suitable for disturbed areas requiring temporary protection until permanent stabilization is established, for disturbed areas that will be re-disturbed following an extended period of inactivity, or to apply permanent stabilization measures. Hydroseeding without mulch or other cover (e.g. EC-7, Erosion Control Blanket) is not a stand-alone erosion control BMP and should be combined with additional measures until vegetation establishment.

Typical applications for hydroseeding include:

- Disturbed soil/graded areas where permanent stabilization or continued earthwork is not anticipated prior to seed germination.
- Cleared and graded areas exposed to seasonal rains or temporary irrigation.
- Areas not subject to heavy wear by construction equipment or high traffic.

Categories

EC	Erosion Control	<input checked="" type="checkbox"/>
SE	Sediment Control	
TC	Tracking Control	
WE	Wind Erosion Control	<input checked="" type="checkbox"/>
NS	Non-Stormwater Management Control	
WM	Waste Management and Materials Pollution Control	

Legend:

- Primary Category
- Secondary Category

Targeted Constituents

Sediment	<input checked="" type="checkbox"/>
Nutrients	
Trash	
Metals	
Bacteria	
Oil and Grease	
Organics	

Potential Alternatives

- EC-3 Hydraulic Mulch
- EC-5 Soil Binders
- EC-6 Straw Mulch
- EC-7 Geotextiles and Mats
- EC-8 Wood Mulching
- EC-14 Compost Blanket
- EC-16 Non-Vegetative Stabilization



Limitations

- Availability of hydroseeding equipment may be limited just prior to the rainy season and prior to storms due to high demand.
- Hydraulic seed should be applied with hydraulic mulch or a stand-alone hydroseed application should be followed by one of the following:
 - Straw mulch (see Straw Mulch EC-6)
 - Rolled erosion control products (see Geotextiles and Mats EC-7)
 - Application of Compost Blanket (see Compost Blanket EC-14)

Hydraulic seed may be used alone only on small flat surfaces when there is sufficient time in the season to ensure adequate vegetation establishment and coverage to provide adequate erosion control.

- Hydraulic seed without mulch does not provide immediate erosion control.
- Temporary seeding may not be appropriate for steep slopes (i.e., slopes readily prone to rill erosion or without sufficient topsoil).
- Temporary seeding may not be appropriate in dry periods without supplemental irrigation.
- Temporary vegetation may have to be removed before permanent vegetation is applied.
- Temporary vegetation may not be appropriate for short term inactivity (i.e. less than 3-6 months).

Implementation

In order to select appropriate hydraulic seed mixtures, an evaluation of site conditions should be performed with respect to:

- | | |
|---|----------------------------------|
| - Soil conditions | - Maintenance requirements |
| - Site topography and exposure (sun/wind) | - Sensitive adjacent areas |
| - Season and climate | - Water availability |
| - Vegetation types | - Plans for permanent vegetation |

The local office of the U.S.D.A. Natural Resources Conservation Service (NRCS) is an excellent source of information on appropriate seed mixes.

The following steps should be followed for implementation:

- Where appropriate or feasible, soil should be prepared to receive the seed by disking or otherwise scarifying (See EC-15, Soil Preparation) the surface to eliminate crust, improve air and water infiltration and create a more favorable environment for germination and growth.

- Avoid use of hydraulic seed in areas where the BMP would be incompatible with future earthwork activities.
- Hydraulic seed can be applied using a multiple step or one step process.
 - In a multiple step process, hydraulic seed is applied first, followed by mulch or a Rolled Erosion Control Product (RECP).
 - In the one step process, hydraulic seed is applied with hydraulic mulch in a hydraulic matrix. When the one step process is used to apply the mixture of fiber, seed, etc., the seed rate should be increased to compensate for all seeds not having direct contact with the soil.
- All hydraulically seeded areas should have mulch, or alternate erosion control cover to keep seeds in place and to moderate soil moisture and temperature until the seeds germinate and grow.
- All seeds should be in conformance with the California State Seed Law of the Department of Agriculture. Each seed bag should be delivered to the site sealed and clearly marked as to species, purity, percent germination, dealer's guarantee, and dates of test. The container should be labeled to clearly reflect the amount of Pure Live Seed (PLS) contained. All legume seed should be pellet inoculated. Inoculant sources should be species specific and should be applied at a rate of 2 lb of inoculant per 100 lb seed.
- Commercial fertilizer should conform to the requirements of the California Food and Agricultural Code, which can be found at http://www.leginfo.ca.gov/.html/fac_table_of_contents.html. Fertilizer should be pelleted or granular form.
- Follow up applications should be made as needed to cover areas of poor coverage or germination/vegetation establishment and to maintain adequate soil protection.
- Avoid over spray onto roads, sidewalks, drainage channels, existing vegetation, etc.
- Additional guidance on the comparison and selection of temporary slope stabilization methods is provided in Appendix F of the Handbook.

Costs

Average cost for installation and maintenance may vary from as low as \$1,900 per acre for flat slopes and stable soils, to \$4,000 per acre for moderate to steep slopes and/or erosive soils. Cost of seed mixtures vary based on types of required vegetation.

BMP	Installed Cost per Acre
Hydraulic Seed	\$1,900-\$4,000

Source: Caltrans Soil Stabilization BMP Research for Erosion and Sediment Controls, July 2007

Inspection and Maintenance

- BMPs must be inspected in accordance with General Permit requirements for the associated project type and risk level. It is recommended that at a minimum, BMPs be inspected weekly, prior to forecasted rain events, daily during extended rain events, and after the conclusion of rain events.
- Areas where erosion is evident should be repaired and BMPs re-applied as soon as possible. Care should be exercised to minimize the damage to protected areas while making repairs, as any area damaged will require re-application of BMPs.
- Where seeds fail to germinate, or they germinate and die, the area must be re-seeded, fertilized, and mulched within the planting season, using not less than half the original application rates.
- Irrigation systems, if applicable, should be inspected daily while in use to identify system malfunctions and line breaks. When line breaks are detected, the system must be shut down immediately and breaks repaired before the system is put back into operation.
- Irrigation systems should be inspected for complete coverage and adjusted as needed to maintain complete coverage.

References

Soil Stabilization BMP Research for Erosion and Sediment Controls: Cost Survey Technical Memorandum, State of California Department of Transportation (Caltrans), July 2007.

Stormwater Quality Handbooks Construction Site Best Management Practices (BMPs) Manual, State of California Department of Transportation (Caltrans), March 2003.

Guidance Document: Soil Stabilization for Temporary Slopes, State of California Department of Transportation (Caltrans), November 1999.

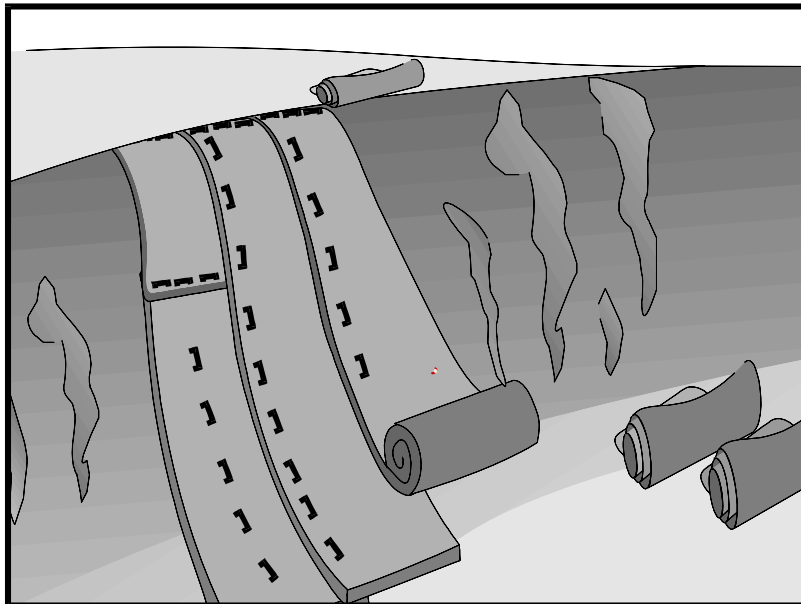

Description and Purpose

Mattings, or Rolled Erosion Control Products (RECPs), can be made of natural or synthetic materials or a combination of the two. RECPs are used to cover the soil surface to reduce erosion from rainfall impact, hold soil in place, and absorb and hold moisture near the soil surface. Additionally, RECPs may be used to stabilize soils until vegetation is established or to reinforce non-woody surface vegetation.

Suitable Applications

RECPs are typically applied on slopes where erosion hazard is high and vegetation will be slow to establish. Mattings are also used on stream banks, swales and other drainage channels where moving water at velocities between 3 ft/s and 6 ft/s are likely to cause scour and wash out new vegetation, and in areas where the soil surface is disturbed and where existing vegetation has been removed. RECPs may also be used when seeding cannot occur (e.g., late season construction and/or the arrival of an early rain season). RECPs should be considered when the soils are fine grained and potentially erosive. RECPs should be considered in the following situations.

- Step slopes, generally steeper than 3:1 (H:V)
- Slopes where the erosion potential is high
- Slopes and disturbed soils where mulch must be anchored
- Disturbed areas where plants are slow to develop

Categories

EC	Erosion Control	<input checked="" type="checkbox"/>
SE	Sediment Control	
TC	Tracking Control	
WE	Wind Erosion Control	<input checked="" type="checkbox"/>
NS	Non-Stormwater Management Control	
WM	Waste Management and Materials Pollution Control	

Legend:

- Primary Category
- Secondary Category

Targeted Constituents

Sediment	<input checked="" type="checkbox"/>
Nutrients	
Trash	
Metals	
Bacteria	
Oil and Grease	
Organics	

Potential Alternatives

- EC-3 Hydraulic Mulch
- EC-4 Hydroseeding



- Channels with flows exceeding 3.3 ft/s
- Channels to be vegetated
- Stockpiles
- Slopes adjacent to water bodies

Limitations

- RECP installed costs are generally higher than other erosion control BMPs, limiting their use to areas where other BMPs are ineffective (e.g. channels, steep slopes).
- RECPs may delay seed germination, due to reduction in soil temperature.
- RECPs are generally not suitable for excessively rocky sites or areas where the final vegetation will be mowed (since staples and netting can catch in mowers). If a staple or pin cannot be driven into the soil because the underlying soil is too hard or rocky, then an alternative BMP should be selected.
- If used for temporary erosion control, RECPs should be removed and disposed of prior to application of permanent soil stabilization measures.
- The use of plastic should be limited to covering stockpiles or very small graded areas for short periods of time (such as through one imminent storm event) until more environmentally friendly measures, such as seeding and mulching, may be installed.
 - Plastic sheeting is easily vandalized, easily torn, photodegradable, and must be disposed of at a landfill.
 - Plastic sheeting results in 100% runoff, which may cause serious erosion problems in the areas receiving the increased flow.
- RECPs may have limitations based on soil type, slope gradient, or channel flow rate; consult the manufacturer for proper selection.
- Not suitable for areas that have foot traffic (tripping hazard) – e.g., pad areas around buildings under construction.
- RECPs that incorporate a plastic netting (e.g. straw blanket typically uses a plastic netting to hold the straw in place) may not be suitable near known wildlife habitat. Wildlife can become trapped in the plastic netting.
- RECPs may have limitations in extremely windy climates. However, when RECPs are properly trenched at the top and bottom and stapled in accordance with the manufacturer's recommendations, problems with wind can be minimized.

Implementation

Material Selection

- Natural RECPs have been found to be effective where re-vegetation will be provided by re-seeding. The choice of material should be based on the size of area, side slopes, surface conditions such as hardness, moisture, weed growth, and availability of materials.
- Additional guidance on the comparison and selection of temporary slope stabilization methods is provided in Appendix F of the Handbook.
- The following natural and synthetic RECPs are commonly used:

Geotextiles

- Material can be a woven or a non-woven polypropylene fabric with minimum thickness of 0.06 in., minimum width of 12 ft and should have minimum tensile strength of 150 lbs (warp), 80 lbs (fill) in conformance with the requirements in ASTM Designation: D 4632. The permittivity of the fabric should be approximately 0.07 sec^{-1} in conformance with the requirements in ASTM Designation: D4491. The fabric should have an ultraviolet (UV) stability of 70 percent in conformance with the requirements in ASTM designation: D4355. Geotextile blankets must be secured in place with wire staples or sandbags and by keying into tops of slopes to prevent infiltration of surface waters under geotextile. Staples should be made of minimum 11 gauge steel wire and should be U-shaped with 8 in. legs and 2 in. crown.
- Geotextiles may be reused if they are suitable for the use intended.

Plastic Covers

- Generally plastic sheeting should only be used as stockpile covering or for very small graded areas for short periods of time (such as through one imminent storm event). If plastic sheeting must be used, choose a plastic that will withstand photo degradation.
- Plastic sheeting should have a minimum thickness of 6 mils, and must be keyed in at the top of slope (when used as a temporary slope protection) and firmly held in place with sandbags or other weights placed no more than 10 ft apart. Seams are typically taped or weighted down their entire length, and there should be at least a 12 in. to 24 in. overlap of all seams. Edges should be embedded a minimum of 6 in. in soil (when used as a temporary slope protection).
- All sheeting must be inspected periodically after installation and after significant rainstorms to check for erosion, undermining, and anchorage failure. Any failures must be repaired immediately. If washout or breakages occur, the material should be re-installed after repairing the damage to the slope.

Erosion Control Blankets/Mats

- Biodegradable RECPs are typically composed of jute fibers, curled wood fibers, straw, coconut fiber, or a combination of these materials. In order for an RECP to be considered 100% biodegradable, the netting, sewing or adhesive system that holds the biodegradable mulch fibers together must also be biodegradable. See typical installation details at the end of this fact sheet.

- **Jute** is a natural fiber that is made into a yarn that is loosely woven into a biodegradable mesh. The performance of jute as a stand-alone RECP is low. Most other RECPs outperform jute as a temporary erosion control product and therefore jute is not commonly used. It is designed to be used in conjunction with vegetation. The material is supplied in rolled strips, which should be secured to the soil with U-shaped staples or stakes in accordance with manufacturers' recommendations.
- **Excelsior** (curled wood fiber) blanket material should consist of machine produced mats of curled wood excelsior with 80 percent of the fiber 6 in. or longer. The excelsior blanket should be of consistent thickness. The wood fiber must be evenly distributed over the entire area of the blanket. The top surface of the blanket should be covered with a photodegradable extruded plastic mesh. The blanket should be smolder resistant without the use of chemical additives and should be non-toxic and non-injurious to plant and animal life. Excelsior blankets should be furnished in rolled strips, a minimum of 48 in. wide, and should have an average weight of 0.8 lb/yd², ±10 percent, at the time of manufacture. Excelsior blankets must be secured in place with wire staples. Staples should be made of minimum 11 gauge steel wire and should be U-shaped with 8 in. legs and 2 in. crown.
- **Straw blanket** should be machine produced mats of straw with a lightweight biodegradable netting top layer. The straw should be attached to the netting with biodegradable thread or glue strips. The straw blanket should be of consistent thickness. The straw should be evenly distributed over the entire area of the blanket. Straw blanket should be furnished in rolled strips a minimum of 6.5 ft wide, a minimum of 80 ft long and a minimum of 0.5 lb/yd². Straw blankets must be secured in place with wire staples. Staples should be made of minimum 11 gauge steel wire and should be U-shaped with 8 in. legs and 2 in. crown.
- **Wood fiber blanket** is composed of biodegradable fiber mulch with extruded plastic netting held together with adhesives. The material is designed to enhance re-vegetation. The material is furnished in rolled strips, which must be secured to the ground with U-shaped staples or stakes in accordance with manufacturers' recommendations.
- **Coconut fiber blanket** should be a machine produced mat of 100 percent coconut fiber with biodegradable netting on the top and bottom. The coconut fiber should be attached to the netting with biodegradable thread or glue strips. The coconut fiber blanket should be of consistent thickness. The coconut fiber should be evenly distributed over the entire area of the blanket. Coconut fiber blanket should be furnished in rolled strips with a minimum of 6.5 ft wide, a minimum of 80 ft. long and a minimum of 0.5 lb/yd². Coconut fiber blankets must be secured in place with wire staples. Staples should be made of minimum 11 gauge steel wire and should be U-shaped with 8 in. legs and 2 in. crown.
- **Coconut fiber mesh** is a thin permeable membrane made from coconut or corn fiber that is spun into a yarn and woven into a biodegradable mat. It is designed to be used in conjunction with vegetation and typically has longevity of several years. The material is supplied in rolled strips, which must be secured to the soil with U-shaped staples or stakes in accordance with manufacturers' recommendations.

- **Straw coconut fiber blanket** should be machine produced mats of 70 percent straw and 30 percent coconut fiber with a biodegradable netting top layer and a biodegradable bottom net. The straw and coconut fiber should be attached to the netting with biodegradable thread or glue strips. The straw coconut fiber blanket should be of consistent thickness. The straw and coconut fiber should be evenly distributed over the entire area of the blanket. Straw coconut fiber blanket should be furnished in rolled strips a minimum of 6.5 ft wide, a minimum of 80 ft long and a minimum of 0.5 lb/yd². Straw coconut fiber blankets must be secured in place with wire staples. Staples should be made of minimum 11 gauge steel wire and should be U-shaped with 8 in. legs and 2 in. crown.
- Non-biodegradable RECPs are typically composed of polypropylene, polyethylene, nylon or other synthetic fibers. In some cases, a combination of biodegradable and synthetic fibers is used to construct the RECP. Netting used to hold these fibers together is typically non-biodegradable as well.
 - **Plastic netting** is a lightweight biaxially oriented netting designed for securing loose mulches like straw or paper to soil surfaces to establish vegetation. The netting is photodegradable. The netting is supplied in rolled strips, which must be secured with U-shaped staples or stakes in accordance with manufacturers' recommendations.
 - **Plastic mesh** is an open weave geotextile that is composed of an extruded synthetic fiber woven into a mesh with an opening size of less than 1/4 in. It is used with re-vegetation or may be used to secure loose fiber such as straw to the ground. The material is supplied in rolled strips, which must be secured to the soil with U-shaped staples or stakes in accordance with manufacturers' recommendations.
 - **Synthetic fiber with netting** is a mat that is composed of durable synthetic fibers treated to resist chemicals and ultraviolet light. The mat is a dense, three dimensional mesh of synthetic (typically polyolefin) fibers stitched between two polypropylene nets. The mats are designed to be re-vegetated and provide a permanent composite system of soil, roots, and geomatrix. The material is furnished in rolled strips, which must be secured with U-shaped staples or stakes in accordance with manufacturers' recommendations.
 - **Bonded synthetic fibers** consist of a three dimensional geomatrix nylon (or other synthetic) matting. Typically it has more than 90 percent open area, which facilitates root growth. It's tough root reinforcing system anchors vegetation and protects against hydraulic lift and shear forces created by high volume discharges. It can be installed over prepared soil, followed by seeding into the mat. Once vegetated, it becomes an invisible composite system of soil, roots, and geomatrix. The material is furnished in rolled strips that must be secured with U-shaped staples or stakes in accordance with manufacturers' recommendations.
 - **Combination synthetic and biodegradable RECPs** consist of biodegradable fibers, such as wood fiber or coconut fiber, with a heavy polypropylene net stitched to the top and a high strength continuous filament geomatrix or net stitched to the bottom. The material is designed to enhance re-vegetation. The material is furnished in rolled strips,

which must be secured with U-shaped staples or stakes in accordance with manufacturers' recommendations.

Site Preparation

- Proper soil preparation is essential to ensure complete contact of the RECP with the soil. Soil Roughening is not recommended in areas where RECPs will be installed.
- Grade and shape the area of installation.
- Remove all rocks, clods, vegetation or other obstructions so that the installed blankets or mats will have complete, direct contact with the soil.
- Prepare seedbed by loosening 2 to 3 in. of topsoil.

Seeding/Planting

Seed the area before blanket installation for erosion control and re-vegetation. Seeding after mat installation is often specified for turf reinforcement application. When seeding prior to blanket installation, all areas disturbed during blanket installation must be re-seeded. Where soil filling is specified for turf reinforcement mats (TRMs), seed the matting and the entire disturbed area after installation and prior to filling the mat with soil.

Fertilize and seed in accordance with seeding specifications or other types of landscaping plans. The protective matting can be laid over areas where grass has been planted and the seedlings have emerged. Where vines or other ground covers are to be planted, lay the protective matting first and then plant through matting according to design of planting.

Check Slots

Check slots shall be installed as required by the manufacturer.

Laying and Securing Matting

- Before laying the matting, all check slots should be installed and the seedbed should be friable, made free from clods, rocks, and roots. The surface should be compacted and finished according to the requirements of the manufacturer's recommendations.
- Mechanical or manual lay down equipment should be capable of handling full rolls of fabric and laying the fabric smoothly without wrinkles or folds. The equipment should meet the fabric manufacturer's recommendations or equivalent standards.

Anchoring

- U-shaped wire staples, metal geotextile stake pins, or triangular wooden stakes can be used to anchor mats and blankets to the ground surface.
- Wire staples should be made of minimum 11 gauge steel wire and should be U-shaped with 8 in. legs and 2 in. crown.
- Metal stake pins should be 0.188 in. diameter steel with a 1.5 in. steel washer at the head of the pin, and 8 in. in length.
- Wire staples and metal stakes should be driven flush to the soil surface.

Installation on Slopes

Installation should be in accordance with the manufacturer's recommendations. In general, these will be as follows:

- Begin at the top of the slope and anchor the blanket in a 6 in. deep by 6 in. wide trench. Backfill trench and tamp earth firmly.
- Unroll blanket down slope in the direction of water flow.
- Overlap the edges of adjacent parallel rolls 2 to 3 in. and staple every 3 ft (or greater, per manufacturer's specifications).
- When blankets must be spliced, place blankets end over end (shingle style) with 6 in. overlap. Staple through overlapped area, approximately 12 in. apart.
- Lay blankets loosely and maintain direct contact with the soil. Do not stretch.
- Staple blankets sufficiently to anchor blanket and maintain contact with the soil. Staples should be placed down the center and staggered with the staples placed along the edges. Steep slopes, 1:1 (H:V) to 2:1 (H:V), require a minimum of 2 staples/yd². Moderate slopes, 2:1 (H:V) to 3:1 (H:V), require a minimum of 1 1/2 staples/yd². Check manufacturer's specifications to determine if a higher density staple pattern is required.

Installation in Channels

Installation should be in accordance with the manufacturer's recommendations. In general, these will be as follows:

- Dig initial anchor trench 12 in. deep and 6 in. wide across the channel at the lower end of the project area.
- Excavate intermittent check slots, 6 in. deep and 6 in. wide across the channel at 25 to 30 ft intervals along the channels.
- Cut longitudinal channel anchor trenches 4 in. deep and 4 in. wide along each side of the installation to bury edges of matting, whenever possible extend matting 2 to 3 in. above the crest of the channel side slopes.
- Beginning at the downstream end and in the center of the channel, place the initial end of the first roll in the anchor trench and secure with fastening devices at 12 in. intervals. Note: matting will initially be upside down in anchor trench.
- In the same manner, position adjacent rolls in anchor trench, overlapping the preceding roll a minimum of 3 in.
- Secure these initial ends of mats with anchors at 12 in. intervals, backfill and compact soil.
- Unroll center strip of matting upstream. Stop at next check slot or terminal anchor trench. Unroll adjacent mats upstream in similar fashion, maintaining a 3 in. overlap.

- Fold and secure all rolls of matting snugly into all transverse check slots. Lay mat in the bottom of the slot then fold back against itself. Anchor through both layers of mat at 12 in. intervals, then backfill and compact soil. Continue rolling all mat widths upstream to the next check slot or terminal anchor trench.
- Alternate method for non-critical installations: Place two rows of anchors on 6 in. centers at 25 to 30 ft. intervals in lieu of excavated check slots.
- Staple shingled lap spliced ends a minimum of 12 in. apart on 12 in. intervals.
- Place edges of outside mats in previously excavated longitudinal slots; anchor using prescribed staple pattern, backfill, and compact soil.
- Anchor, fill, and compact upstream end of mat in a 12 in. by 6 in. terminal trench.
- Secure mat to ground surface using U-shaped wire staples, geotextile pins, or wooden stakes.
- Seed and fill turf reinforcement matting with soil, if specified.

Soil Filling (if specified for turf reinforcement mat (TRM))

Installation should be in accordance with the manufacturer's recommendations. Typical installation guidelines are as follows:

- After seeding, spread and lightly rake 1/2-3/4 inches of fine topsoil into the TRM apertures to completely fill TRM thickness. Use backside of rake or other flat implement.
- Alternatively, if allowed by product specifications, spread topsoil using lightweight loader, backhoe, or other power equipment. Avoid sharp turns with equipment.
- Always consult the manufacturer's recommendations for installation.
- Do not drive tracked or heavy equipment over mat.
- Avoid any traffic over matting if loose or wet soil conditions exist.
- Use shovels, rakes, or brooms for fine grading and touch up.
- Smooth out soil filling just exposing top netting of mat.

Temporary Soil Stabilization Removal

- Temporary soil stabilization removed from the site of the work must be disposed of if necessary.

Costs

Installed costs can be relatively high compared to other BMPs. Approximate costs for installed materials are shown below:

Rolled Erosion Control Products		Installed Cost per Acre (2000) ¹	Estimated Cost per Acre (2009) ²
Biodegradable	Jute Mesh	\$6,000-\$7,000	\$6,600-\$7,700
	Curled Wood Fiber	\$8,000-\$10,500	\$8,800-\$11,050
	Straw	\$8,000-\$10,500	\$8,800-\$11,050
	Wood Fiber	\$8,000-\$10,500	\$8,800-\$11,050
	Coconut Fiber	\$13,000-\$14,000	\$14,300-\$15,400
	Coconut Fiber Mesh	\$30,000-\$33,000	\$33,000-\$36,300
	Straw Coconut Fiber	\$10,000-\$12,000	\$11,000-\$13,200
Non-Biodegradable	Plastic Netting	\$2,000-\$2,200	\$2,200-\$2,220
	Plastic Mesh	\$3,000-\$3,500	\$3,300-\$3,850
	Synthetic Fiber with Netting	\$34,000-\$40,000	\$37,400-\$44,000
	Bonded Synthetic Fibers	\$45,000-\$55,000	\$49,500-\$60,500
	Combination with Biodegradable	\$30,000-\$36,000	\$33,000-\$39,600

1. Source: Erosion Control Pilot Study Report, Caltrans, June 2000.

2. 2009 costs reflect a 10% escalation over year 2000 costs. Escalation based on informal survey of industry trends. Note: Expected cost increase is offset by competitive economic conditions.

Inspection and Maintenance

- RECPs must be inspected in accordance with General Permit requirements for the associated project type and risk level. It is recommended that at a minimum, BMPs be inspected weekly, prior to forecasted rain events, daily during extended rain events, and after the conclusion of rain events.
- Areas where erosion is evident shall be repaired and BMPs reapplied as soon as possible. Care should be exercised to minimize the damage to protected areas while making repairs, as any area damaged will require reapplication of BMPs.
- If washout or breakage occurs, re-install the material after repairing the damage to the slope or channel.
- Make sure matting is uniformly in contact with the soil.
- Check that all the lap joints are secure.
- Check that staples are flush with the ground.

References

Erosion and Sediment Control Manual, Oregon Department of Environmental Quality, February 2005

Erosion Control Pilot Study Report, State of California Department of Transportation (Caltrans), June 2000.

Guides for Erosion and Sediment Controls in California, USDA Soils Conservation Service, January 1991.

National Management Measures to Control Nonpoint Source Pollution from Urban Areas, United States Environmental Protection Agency, 2002.

Stormwater Quality Handbooks Construction Site Best Management Practices (BMPs) Manual, State of California Department of Transportation (Caltrans), March 2003.

Guidance Document: Soil Stabilization for Temporary Slopes, State of California Department of Transportation (Caltrans), November 1999.

Stormwater Management of the Puget Sound Basin, Technical Manual, Publication #91-75, Washington State Department of Ecology, February 1992.

Water Quality Management Plan for The Lake Tahoe Region, Volume II, Handbook of Management Practices, Tahoe Regional Planning Agency, November 1988.

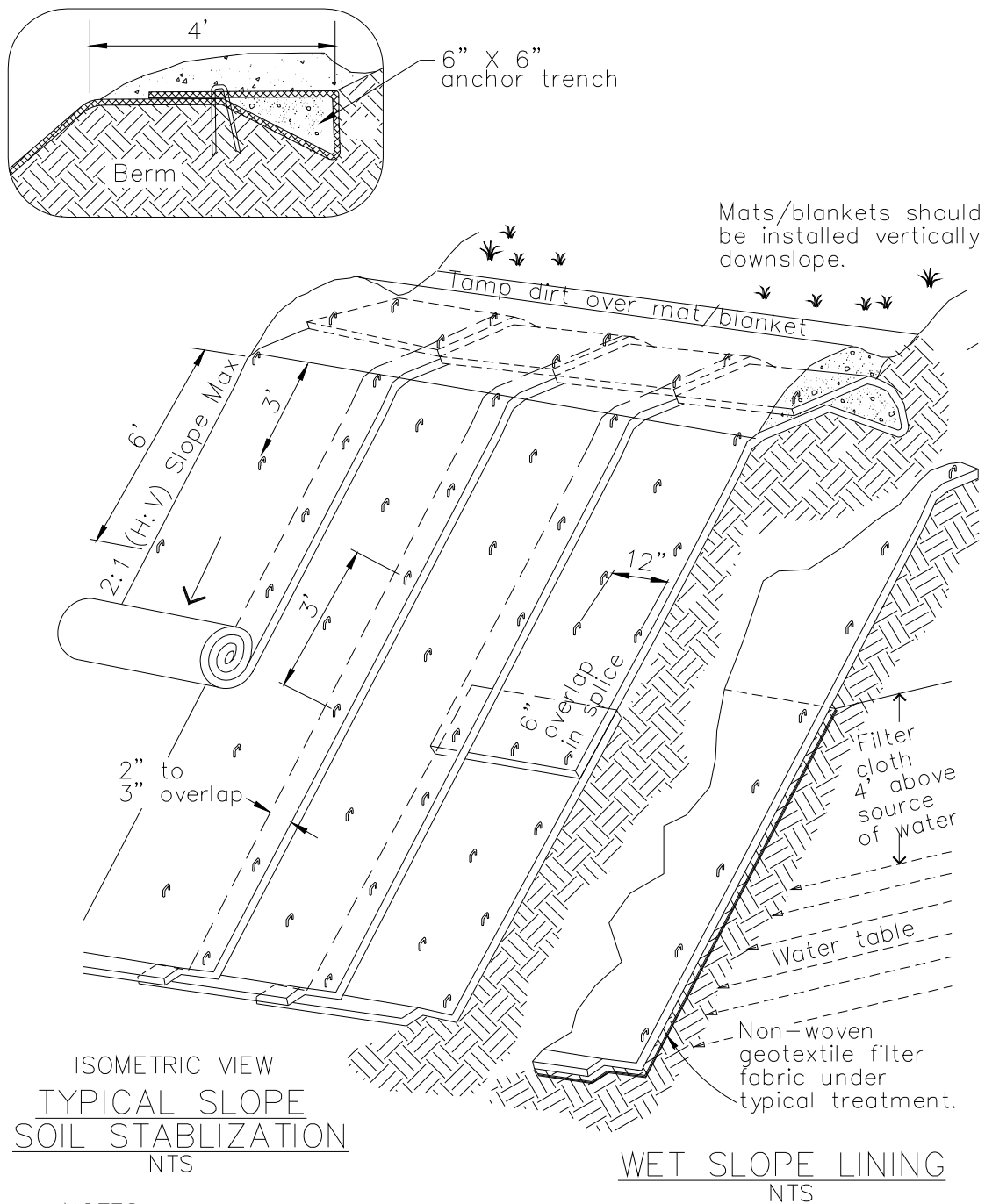

NOTES:

1. Slope surface shall be free of rocks, clods, sticks and grass. Mats/blankets shall have good soil contact.
2. Lay blankets loosely and stake or staple to maintain direct contact with the soil. Do not stretch.
3. Install per manufacturer's recommendations

TYPICAL INSTALLATION DETAIL

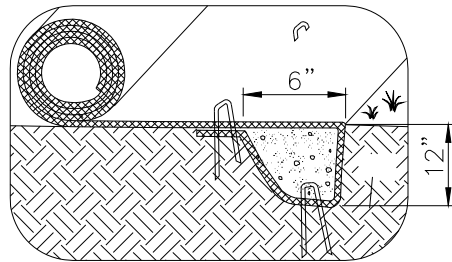

INITIAL CHANNEL ANCHOR TRENCH
NTS

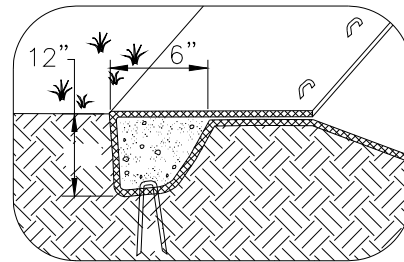

TERMINAL SLOPE AND CHANNEL
ANCHOR TRENCH
NTS

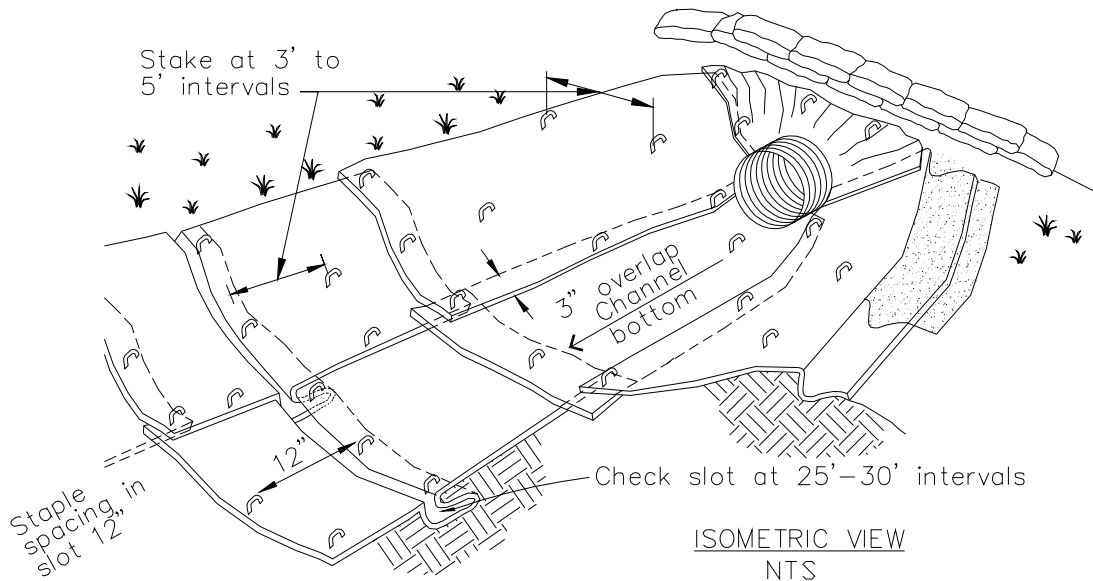

ISOMETRIC VIEW
NTS

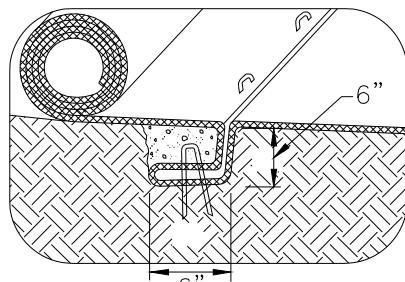

INTERMITTENT CHECK SLOT
NTS

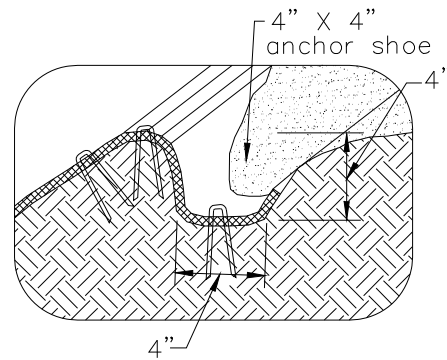

LONGITUDINAL ANCHOR TRENCH
NTS

NOTES:

1. Check slots to be constructed per manufacturers specifications.
2. Staking or stapling layout per manufacturers specifications.
3. Install per manufacturer's recommendations

TYPICAL INSTALLATION DETAIL

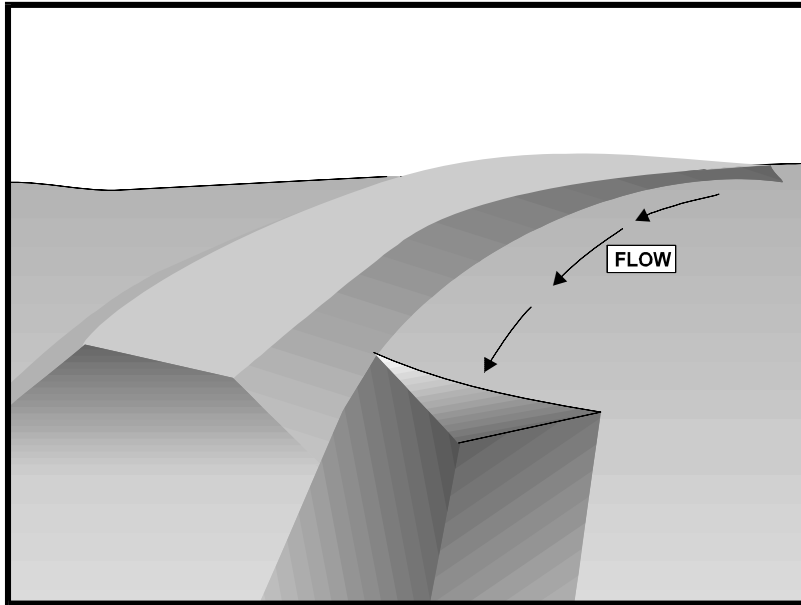

Description and Purpose

An earth dike is a temporary berm or ridge of compacted soil used to divert runoff or channel water to a desired location. A drainage swale is a shaped and sloped depression in the soil surface used to convey runoff to a desired location. Earth dikes and drainage swales are used to divert off site runoff around the construction site, divert runoff from stabilized areas and disturbed areas, and direct runoff into sediment basins or traps.

Suitable Applications

Earth dikes and drainage swales are suitable for use, individually or together, where runoff needs to be diverted from one area and conveyed to another.

- Earth dikes and drainage swales may be used:
 - To convey surface runoff down sloping land
 - To intercept and divert runoff to avoid sheet flow over sloped surfaces
 - To divert and direct runoff towards a stabilized watercourse, drainage pipe or channel
 - To intercept runoff from paved surfaces
 - Below steep grades where runoff begins to concentrate
 - Along roadways and facility improvements subject to flood drainage

Categories

EC	Erosion Control	<input checked="" type="checkbox"/>
SE	Sediment Control	
TC	Tracking Control	
WE	Wind Erosion Control	
NS	Non-Stormwater Management Control	
WM	Waste Management and Materials Pollution Control	

Legend:

- Primary Objective
- Secondary Objective

Targeted Constituents

Sediment	<input checked="" type="checkbox"/>
Nutrients	
Trash	
Metals	
Bacteria	
Oil and Grease	
Organics	

Potential Alternatives

None



- At the top of slopes to divert runoff from adjacent or undisturbed slopes
- At bottom and mid slope locations to intercept sheet flow and convey concentrated flows
- Divert sediment laden runoff into sediment basins or traps

Limitations

Dikes should not be used for drainage areas greater than 10 acres or along slopes greater than 10 percent. For larger areas more permanent drainage structures should be built. All drainage structures should be built in compliance with local municipal requirements.

- Earth dikes may create more disturbed area on site and become barriers to construction equipment.
- Earth dikes must be stabilized immediately, which adds cost and maintenance concerns.
- Diverted stormwater may cause downstream flood damage.
- Dikes should not be constructed of soils that may be easily eroded.
- Regrading the site to remove the dike may add additional cost.
- Temporary drains and swales or any other diversion of runoff should not adversely impact upstream or downstream properties.
- Temporary drains and swales must conform to local floodplain management requirements.
- Earth dikes/drainage swales are not suitable as sediment trapping devices.
- It may be necessary to use other soil stabilization and sediment controls such as check dams, plastics, and blankets, to prevent scour and erosion in newly graded dikes, swales, and ditches.
- Sediment accumulation, scour depressions, and/or persistent non-stormwater discharges can result in areas of standing water suitable for mosquito production in drainage swales.

Implementation

The temporary earth dike is a berm or ridge of compacted soil, located in such a manner as to divert stormwater to a sediment trapping device or a stabilized outlet, thereby reducing the potential for erosion and offsite sedimentation. Earth dikes can also be used to divert runoff from off site and from undisturbed areas away from disturbed areas and to divert sheet flows away from unprotected slopes.

An earth dike does not itself control erosion or remove sediment from runoff. A dike prevents erosion by directing runoff to an erosion control device such as a sediment trap or directing runoff away from an erodible area. Temporary diversion dikes should not adversely impact adjacent properties and must conform to local floodplain management regulations, and should not be used in areas with slopes steeper than 10%.

Slopes that are formed during cut and fill operations should be protected from erosion by runoff. A combination of a temporary drainage swale and an earth dike at the top of a slope can divert

runoff to a location where it can be brought to the bottom of the slope (see EC-11, Slope Drains). A combination dike and swale is easily constructed by a single pass of a bulldozer or grader and compacted by a second pass of the tracks or wheels over the ridge. Diversion structures should be installed when the site is initially graded and remain in place until post construction BMPs are installed and the slopes are stabilized.

Diversion practices concentrate surface runoff, increasing its velocity and erosive force. Thus, the flow out of the drain or swale must be directed onto a stabilized area or into a grade stabilization structure. If significant erosion will occur, a swale should be stabilized using vegetation, chemical treatment, rock rip-rap, matting, or other physical means of stabilization. Any drain or swale that conveys sediment laden runoff must be diverted into a sediment basin or trap before it is discharged from the site.

General

- Care must be applied to correctly size and locate earth dikes, drainage swales. Excessively steep, unlined dikes, and swales are subject to erosion and gully formation.
- Conveyances should be stabilized.
- Use a lined ditch for high flow velocities.
- Select flow velocity based on careful evaluation of the risks due to erosion of the measure, soil types, overtopping, flow backups, washout, and drainage flow patterns for each project site.
- Compact any fills to prevent unequal settlement.
- Do not divert runoff onto other property without securing written authorization from the property owner.
- When possible, install and utilize permanent dikes, swales, and ditches early in the construction process.
- Provide stabilized outlets.

Earth Dikes

Temporary earth dikes are a practical, inexpensive BMP used to divert stormwater runoff. Temporary diversion dikes should be installed in the following manner:

- All dikes should be compacted by earth moving equipment.
- All dikes should have positive drainage to an outlet.
- All dikes should have 2:1 or flatter side slopes, 18 in. minimum height, and a minimum top width of 24 in. Wide top widths and flat slopes are usually needed at crossings for construction traffic.
- The outlet from the earth dike must function with a minimum of erosion. Runoff should be conveyed to a sediment trapping device such as a Sediment Trap (SE-3) or Sediment Basin

(SE-2) when either the dike channel or the drainage area above the dike are not adequately stabilized.

- Temporary stabilization may be achieved using seed and mulching for slopes less than 5% and either rip-rap or sod for slopes in excess of 5%. In either case, stabilization of the earth dike should be completed immediately after construction or prior to the first rain.
- If riprap is used to stabilize the channel formed along the toe of the dike, the following typical specifications apply:

Channel Grade	Riprap Stabilization
0.5-1.0%	4 in. Rock
1.1-2.0%	6 in. Rock
2.1-4.0%	8 in. Rock
4.1-5.0%	8 in. -12 in. Riprap

- The stone riprap, recycled concrete, etc. used for stabilization should be pressed into the soil with construction equipment.
- Filter cloth may be used to cover dikes in use for long periods.
- Construction activity on the earth dike should be kept to a minimum.

Drainage Swales

Drainage swales are only effective if they are properly installed. Swales are more effective than dikes because they tend to be more stable. The combination of a swale with a dike on the downhill side is the most cost effective diversion.

Standard engineering design criteria for small open channel and closed conveyance systems should be used (see the local drainage design manual). Unless local drainage design criteria state otherwise, drainage swales should be designed as follows:

- No more than 5 acres may drain to a temporary drainage swale.
- Place drainage swales above or below, not on, a cut or fill slope.
- Swale bottom width should be at least 2 ft
- Depth of the swale should be at least 18 in.
- Side slopes should be 2:1 or flatter.
- Drainage or swales should be laid at a grade of at least 1 percent, but not more than 15 percent.
- The swale must not be overtopped by the peak discharge from a 10-year storm, irrespective of the design criteria stated above.

- Remove all trees, stumps, obstructions, and other objectionable material from the swale when it is built.
- Compact any fill material along the path of the swale.
- Stabilize all swales immediately. Seed and mulch swales at a slope of less than 5 percent, and use rip-rap or sod for swales with a slope between 5 and 15 percent. For temporary swales, geotextiles and mats (EC-7) may provide immediate stabilization.
- Irrigation may be required to establish sufficient vegetation to prevent erosion.
- Do not operate construction vehicles across a swale unless a stabilized crossing is provided.
- Permanent drainage facilities must be designed by a professional engineer (see the local drainage design criteria for proper design).
- At a minimum, the drainage swale should conform to predevelopment drainage patterns and capacities.
- Construct the drainage swale with a positive grade to a stabilized outlet.
- Provide erosion protection or energy dissipation measures if the flow out of the drainage swale can reach an erosive velocity.

Costs

- Cost ranges from \$15 to \$55 per ft for both earthwork and stabilization and depends on availability of material, site location, and access.
- Small dikes: \$2.50 - \$6.50/linear ft; Large dikes: \$2.50/yd³.
- The cost of a drainage swale increases with drainage area and slope. Typical swales for controlling internal erosion are inexpensive, as they are quickly formed during routine earthwork.

Inspection and Maintenance

- Inspect BMPs prior to forecast rain, daily during extended rain events, after rain events, weekly during the rainy season, and at two-week intervals during the non-rainy season.
- Inspect BMPs subject to non-stormwater discharges daily while non-stormwater discharges occur.
- Inspect ditches and berms for washouts. Replace lost riprap, damaged linings or soil stabilizers as needed.
- Inspect channel linings, embankments, and beds of ditches and berms for erosion and accumulation of debris and sediment. Remove debris and sediment and repair linings and embankments as needed.
- Temporary conveyances should be completely removed as soon as the surrounding drainage area has been stabilized or at the completion of construction

References

Erosion and Sediment Control Handbook, S.J. Goldman, K. Jackson, T.A. Bursetynsky, P.E., McGraw Hill Book Company, 1986.

Manual of Standards of Erosion and Sediment Control Measures, Association of Bay Area Governments, May 1995.

Metzger, M.E. 2004. Managing mosquitoes in stormwater treatment devices. University of California Division of Agriculture and Natural Resources, Publication 8125. On-line: <http://anrcatalog.ucdavis.edu/pdf/8125.pdf>

National Association of Home Builders (NAHB). Stormwater Runoff & Nonpoint Source Pollution Control Guide for Builders and Developers. National Association of Home Builders, Washington, D.C., 1995

National Management Measures to Control Nonpoint Source Pollution from Urban Areas, United States Environmental Protection Agency, 2002.

Southeastern Wisconsin Regional Planning Commission (SWRPC). Costs of Urban Nonpoint Source Water Pollution Control Measures. Technical Report No. 31. Southeastern Wisconsin Regional Planning Commission, Waukesha, WI. 1991

Stormwater Quality Handbooks Construction Site Best Management Practices (BMPs) Manual, State of California Department of Transportation (Caltrans), November 2000.

Stormwater Management of the Puget Sound Basin, Technical Manual, Publication #91-75, Washington State Department of Ecology, February 1992.

Water Quality Management Plan for the Lake Tahoe Region, Volume II, Handbook of Management Practices, Tahoe Regional Planning Agency, November 1988.

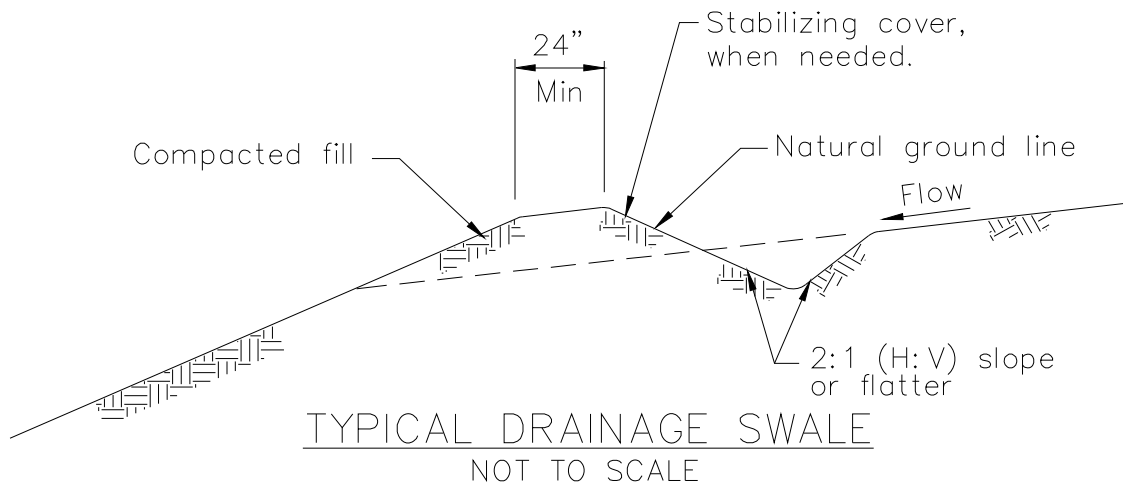

NOTES:

1. Stabilize inlet, outlets and slopes.
2. Properly compact the subgrade.

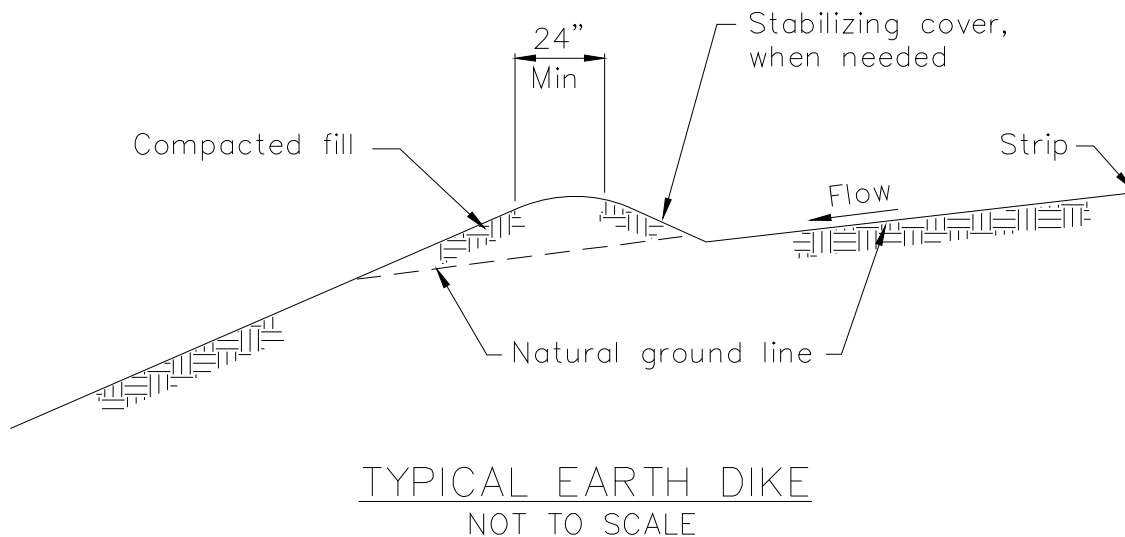

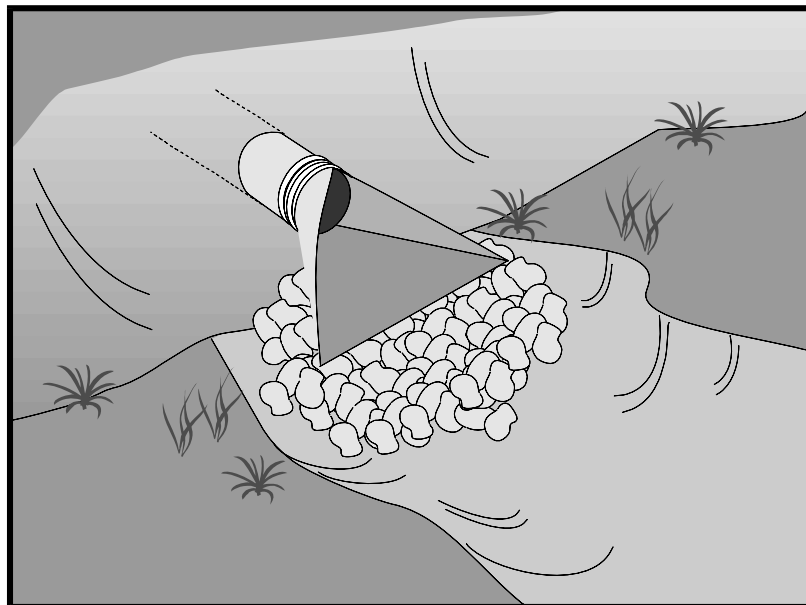

Description and Purpose

Outlet protection is a physical device composed of rock, grouted riprap, or concrete rubble, which is placed at the outlet of a pipe or channel to prevent scour of the soil caused by concentrated, high velocity flows.

Suitable Applications

Whenever discharge velocities and energies at the outlets of culverts, conduits, or channels are sufficient to erode the next downstream reach. This includes temporary diversion structures to divert runoff during construction.

- These devices may be used at the following locations:
 - Outlets of pipes, drains, culverts, slope drains, diversion ditches, swales, conduits, or channels.
 - Outlets located at the bottom of mild to steep slopes.
 - Discharge outlets that carry continuous flows of water.
 - Outlets subject to short, intense flows of water, such as flash floods.
 - Points where lined conveyances discharge to unlined conveyances

Limitations

- Large storms or high flows can wash away the rock outlet protection and leave the area susceptible to erosion.

Categories

EC	Erosion Control	<input checked="" type="checkbox"/>
SE	Sediment Control	
TC	Tracking Control	
WE	Wind Erosion Control	
NS	Non-Stormwater Management Control	
WM	Waste Management and Materials Pollution Control	

Legend:

- Primary Objective
- Secondary Objective

Targeted Constituents

Sediment	<input checked="" type="checkbox"/>
Nutrients	
Trash	
Metals	
Bacteria	
Oil and Grease	
Organics	

Potential Alternatives

None



- Sediment captured by the rock outlet protection may be difficult to remove without removing the rock.
- Outlet protection may negatively impact the channel habitat.
- Grouted riprap may break up in areas of freeze and thaw.
- If there is not adequate drainage, and water builds up behind grouted riprap, it may cause the grouted riprap to break up due to the resulting hydrostatic pressure.
- Sediment accumulation, scour depressions, and/or persistent non-stormwater discharges can result in areas of standing water suitable for mosquito production in velocity dissipation devices.

Implementation

General

Outlet protection is needed where discharge velocities and energies at the outlets of culverts, conduits or channels are sufficient to erode the immediate downstream reach. This practice protects the outlet from developing small eroded pools (plunge pools), and protects against gully erosion resulting from scouring at a culvert mouth.

Design and Layout

As with most channel design projects, depth of flow, roughness, gradient, side slopes, discharge rate, and velocity should be considered in the outlet design. Compliance to local and state regulations should also be considered while working in environmentally sensitive streambeds. General recommendations for rock size and length of outlet protection mat are shown in the rock outlet protection figure in this BMP and should be considered minimums. The apron length and rock size gradation are determined using a combination of the discharge pipe diameter and estimate discharge rate: Select the longest apron length and largest rock size suggested by the pipe size and discharge rate. Where flows are conveyed in open channels such as ditches and swales, use the estimated discharge rate for selecting the apron length and rock size. Flows should be same as the culvert or channel design flow but never the less than the peak 5 year flow for temporary structures planned for one rainy season, or the 10 year peak flow for temporary structures planned for two or three rainy seasons.

- There are many types of energy dissipaters, with rock being the one that is represented in the attached figure.
- Best results are obtained when sound, durable, and angular rock is used.
- Install riprap, grouted riprap, or concrete apron at selected outlet. Riprap aprons are best suited for temporary use during construction. Grouted or wired tied rock riprap can minimize maintenance requirements.
- Rock outlet protection is usually less expensive and easier to install than concrete aprons or energy dissipaters. It also serves to trap sediment and reduce flow velocities.
- Carefully place riprap to avoid damaging the filter fabric.

- Stone 4 in. to 6 in. may be carefully dumped onto filter fabric from a height not to exceed 12 in.
 - Stone 8 in. to 12 in. must be hand placed onto filter fabric, or the filter fabric may be covered with 4 in. of gravel and the 8 in. to 12 in. rock may be dumped from a height not to exceed 16 in.
 - Stone greater than 12 in. shall only be dumped onto filter fabric protected with a layer of gravel with a thickness equal to one half the D_{50} rock size, and the dump height limited to twice the depth of the gravel protection layer thickness.
- For proper operation of apron: Align apron with receiving stream and keep straight throughout its length. If a curve is needed to fit site conditions, place it in upper section of apron.
 - Outlets on slopes steeper than 10 percent should have additional protection.

Costs

Costs are low if material is readily available. If material is imported, costs will be higher. Average installed cost is \$150 per device.

Inspection and Maintenance

- Inspect BMPs prior to forecast rain, daily during extended rain events, after rain events, weekly during the rainy season, and at two-week intervals during the non-rainy season.
- Inspect BMPs subjected to non-stormwater discharges daily while non-stormwater discharges occur. Minimize areas of standing water by removing sediment blockages and filling scour depressions.
- Inspect apron for displacement of the riprap and damage to the underlying fabric. Repair fabric and replace riprap that has washed away. If riprap continues to wash away, consider using larger material.
- Inspect for scour beneath the riprap and around the outlet. Repair damage to slopes or underlying filter fabric immediately.
- Temporary devices should be completely removed as soon as the surrounding drainage area has been stabilized or at the completion of construction.

References

County of Sacramento Improvement Standards, Sacramento County, May 1989.

Erosion and Sediment Control Handbook, S.J. Goldman, K. Jackson, T.A. Bursztynsky, P.E., McGraw Hill Book Company, 1986.

Handbook of Steel Drainage & Highway Construction, American Iron and Steel Institute, 1983.

Manual of Standards of Erosion and Sediment Control Measures, Association of Bay Area Governments, May 1995.

Metzger, M.E. 2004. Managing mosquitoes in stormwater treatment devices. University of California Division of Agriculture and Natural Resources, Publication 8125. On-line: <http://anrcatalog.ucdavis.edu/pdf/8125.pdf>

Stormwater Quality Handbooks Construction Site Best Management Practices (BMPs) Manual, state of California Department of Transportation (Caltrans), November 2000.

Stormwater Management of the Puget Sound Basin, Technical Manual, Publication #91-75, Washington State Department of Ecology, February 1992.

Water Quality Management Plan for the Lake Tahoe Region, Volume II, Handbook of Management Practices, Tahoe Regional Planning Agency, November 1988.

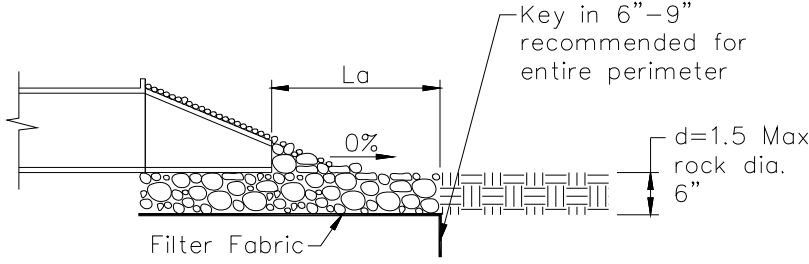
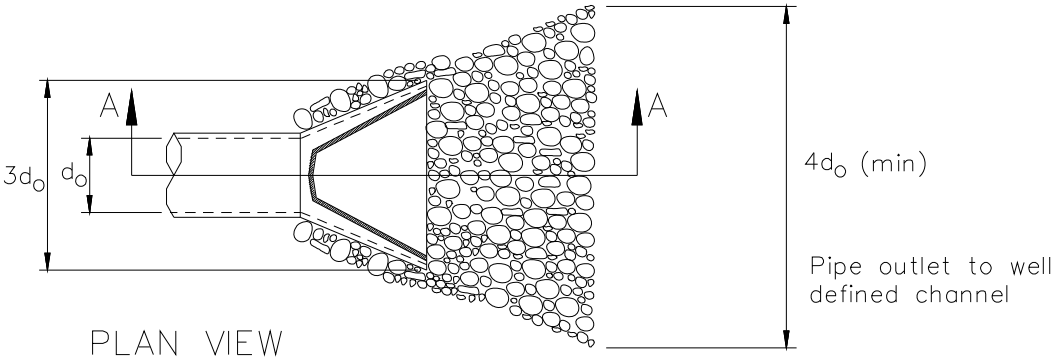

Pipe Diameter inches	Discharge ft ³ /s	Apron Length, La ft	Rip Rap D ₅₀ Diameter Min inches
12	5	10	4
	10	13	6
18	10	10	6
	20	16	8
	30	23	12
24	40	26	16
	30	16	8
	40	26	8
	50	26	12
	60	30	16

For larger or higher flows consult a Registered Civil Engineer
 Source: USDA - SCS

Stabilized Construction Entrance/Exit TC-1

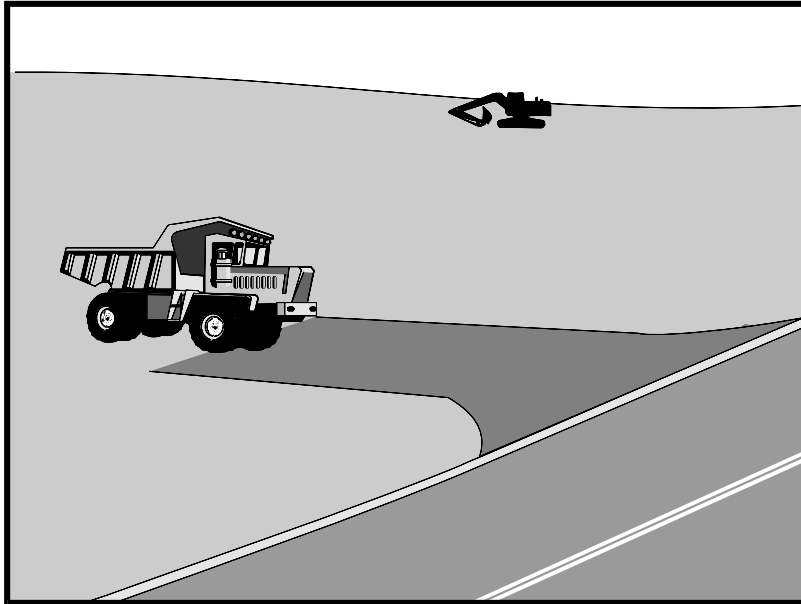

Description and Purpose

A stabilized construction access is defined by a point of entrance/exit to a construction site that is stabilized to reduce the tracking of mud and dirt onto public roads by construction vehicles.

Suitable Applications

Use at construction sites:

- Where dirt or mud can be tracked onto public roads.
- Adjacent to water bodies.
- Where poor soils are encountered.
- Where dust is a problem during dry weather conditions.

Limitations

- Entrances and exits require periodic top dressing with additional stones.
- This BMP should be used in conjunction with street sweeping on adjacent public right of way.
- Entrances and exits should be constructed on level ground only.
- Stabilized construction entrances are rather expensive to construct and when a wash rack is included, a sediment trap of some kind must also be provided to collect wash water

Categories

EC	Erosion Control	<input checked="" type="checkbox"/>
SE	Sediment Control	<input checked="" type="checkbox"/>
TC	Tracking Control	<input checked="" type="checkbox"/>
WE	Wind Erosion Control	
NS	Non-Stormwater Management Control	
WM	Waste Management and Materials Pollution Control	

Legend:

- Primary Objective
- Secondary Objective

Targeted Constituents

Sediment	<input checked="" type="checkbox"/>
Nutrients	
Trash	
Metals	
Bacteria	
Oil and Grease	
Organics	

Potential Alternatives

None



Stabilized Construction Entrance/Exit TC-1

runoff.

Implementation

General

A stabilized construction entrance is a pad of aggregate underlain with filter cloth located at any point where traffic will be entering or leaving a construction site to or from a public right of way, street, alley, sidewalk, or parking area. The purpose of a stabilized construction entrance is to reduce or eliminate the tracking of sediment onto public rights of way or streets. Reducing tracking of sediments and other pollutants onto paved roads helps prevent deposition of sediments into local storm drains and production of airborne dust.

Where traffic will be entering or leaving the construction site, a stabilized construction entrance should be used. NPDES permits require that appropriate measures be implemented to prevent tracking of sediments onto paved roadways, where a significant source of sediments is derived from mud and dirt carried out from unpaved roads and construction sites.

Stabilized construction entrances are moderately effective in removing sediment from equipment leaving a construction site. The entrance should be built on level ground. Advantages of the Stabilized Construction Entrance/Exit is that it does remove some sediment from equipment and serves to channel construction traffic in and out of the site at specified locations. Efficiency is greatly increased when a washing rack is included as part of a stabilized construction entrance/exit.

Design and Layout

- Construct on level ground where possible.
- Select 3 to 6 in. diameter stones.
- Use minimum depth of stones of 12 in. or as recommended by soils engineer.
- Construct length of 50 ft minimum, and 30 ft minimum width.
- Rumble racks constructed of steel panels with ridges and installed in the stabilized entrance/exit will help remove additional sediment and to keep adjacent streets clean.
- Provide ample turning radii as part of the entrance.
- Limit the points of entrance/exit to the construction site.
- Limit speed of vehicles to control dust.
- Properly grade each construction entrance/exit to prevent runoff from leaving the construction site.
- Route runoff from stabilized entrances/exits through a sediment trapping device before discharge.
- Design stabilized entrance/exit to support heaviest vehicles and equipment that will use it.

Stabilized Construction Entrance/Exit TC-1

- Select construction access stabilization (aggregate, asphaltic concrete, concrete) based on longevity, required performance, and site conditions. Do not use asphalt concrete (AC) grindings for stabilized construction access/roadway.
- If aggregate is selected, place crushed aggregate over geotextile fabric to at least 12 in. depth, or place aggregate to a depth recommended by a geotechnical engineer. A crushed aggregate greater than 3 in. but smaller than 6 in. should be used.
- Designate combination or single purpose entrances and exits to the construction site.
- Require that all employees, subcontractors, and suppliers utilize the stabilized construction access.
- Implement SE-7, Street Sweeping and Vacuuming, as needed.
- All exit locations intended to be used for more than a two-week period should have stabilized construction entrance/exit BMPs.

Inspection and Maintenance

- Inspect and verify that activity-based BMPs are in place prior to the commencement of associated activities. While activities associated with the BMPs are under way, inspect weekly during the rainy season and of two-week intervals in the non-rainy season to verify continued BMP implementation.
- Inspect local roads adjacent to the site daily. Sweep or vacuum to remove visible accumulated sediment.
- Remove aggregate, separate and dispose of sediment if construction entrance/exit is clogged with sediment.
- Keep all temporary roadway ditches clear.
- Check for damage and repair as needed.
- Replace gravel material when surface voids are visible.
- Remove all sediment deposited on paved roadways within 24 hours.
- Remove gravel and filter fabric at completion of construction

Costs

Average annual cost for installation and maintenance may vary from \$1,200 to \$4,800 each, averaging \$2,400 per entrance. Costs will increase with addition of washing rack, and sediment trap. With wash rack, costs range from \$1,200 - \$6,000 each, averaging \$3,600 per entrance.

References

Manual of Standards of Erosion and Sediment Control Measures, Association of Bay Area Governments, May 1995.

Stabilized Construction Entrance/Exit TC-1

National Management Measures to Control Nonpoint Source Pollution from Urban Areas, USEPA Agency, 2002.

Proposed Guidance Specifying Management Measures for Sources of Nonpoint Pollution in Coastal Waters, Work Group Working Paper, USEPA, April 1992.

Stormwater Quality Handbooks Construction Site Best Management Practices (BMPs) Manual, State of California Department of Transportation (Caltrans), November 2000.

Stormwater Management of the Puget Sound Basin, Technical Manual, Publication #91-75, Washington State Department of Ecology, February 1992.

Virginia Erosion and Sedimentation Control Handbook, Virginia Department of Conservation and Recreation, Division of Soil and Water Conservation, 1991.

Guidance Specifying Management Measures for Nonpoint Pollution in Coastal Waters, EPA 840-B-9-002, USEPA, Office of Water, Washington, DC, 1993.

Water Quality Management Plan for the Lake Tahoe Region, Volume II, Handbook of Management Practices, Tahoe Regional Planning Agency, November 1988.

Stabilized Construction Entrance/Exit TC-1

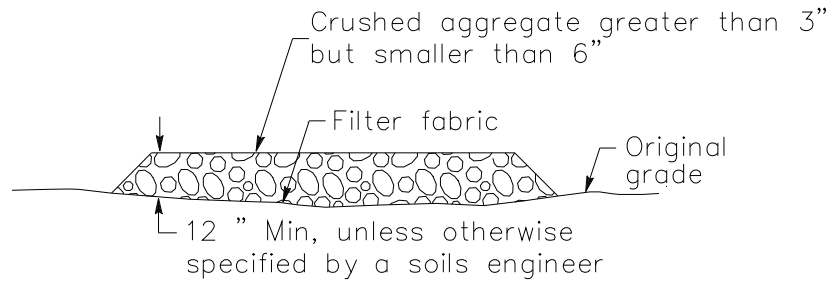

SECTION B-B
NTS

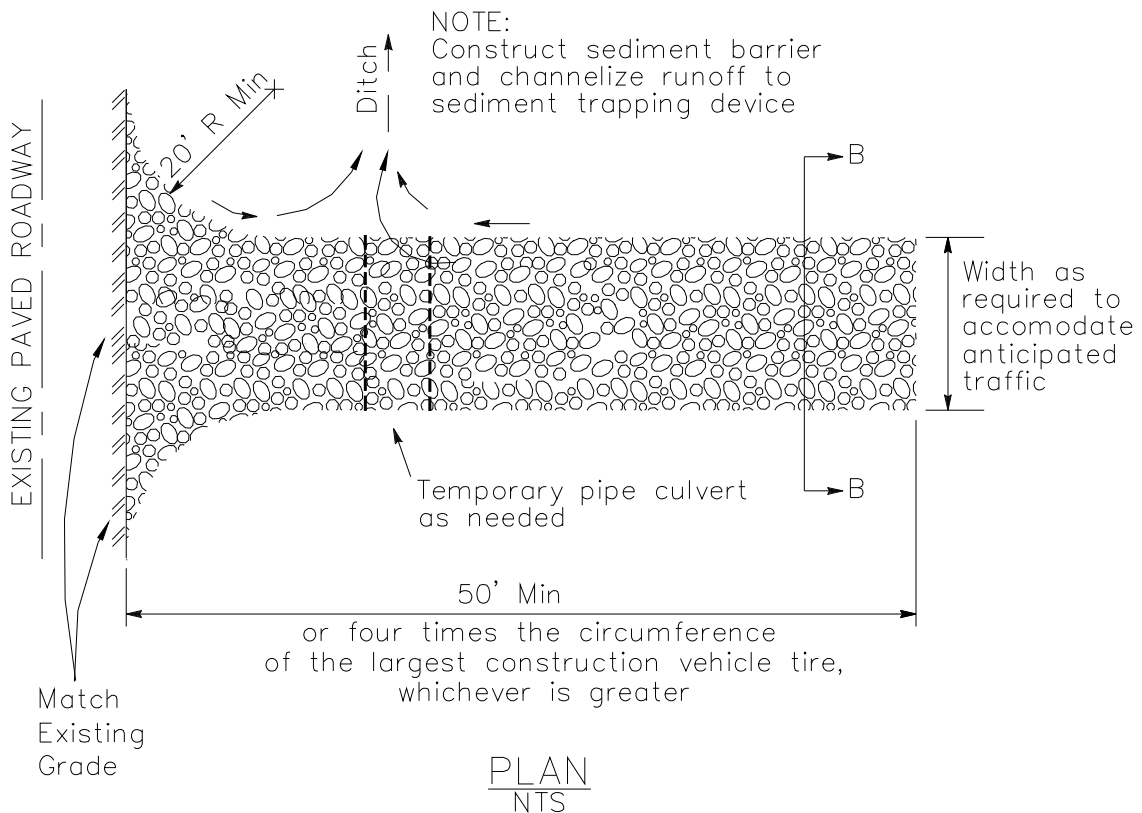

Stabilized Construction Entrance/Exit TC-1

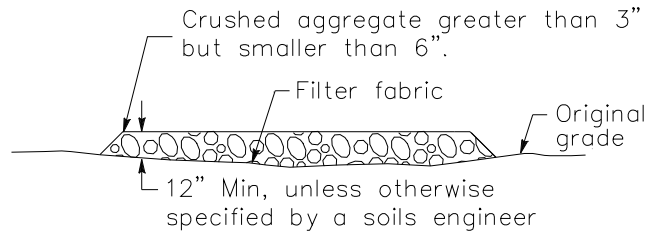

SECTION B-B
NTS

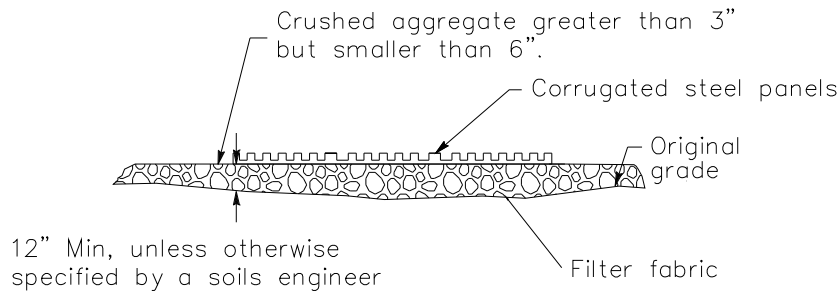

SECTION A-A
NOT TO SCALE

NOTE:
Construct sediment barrier and channelize runoff to sediment trapping device

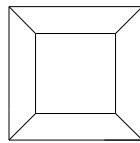

Sediment trapping device

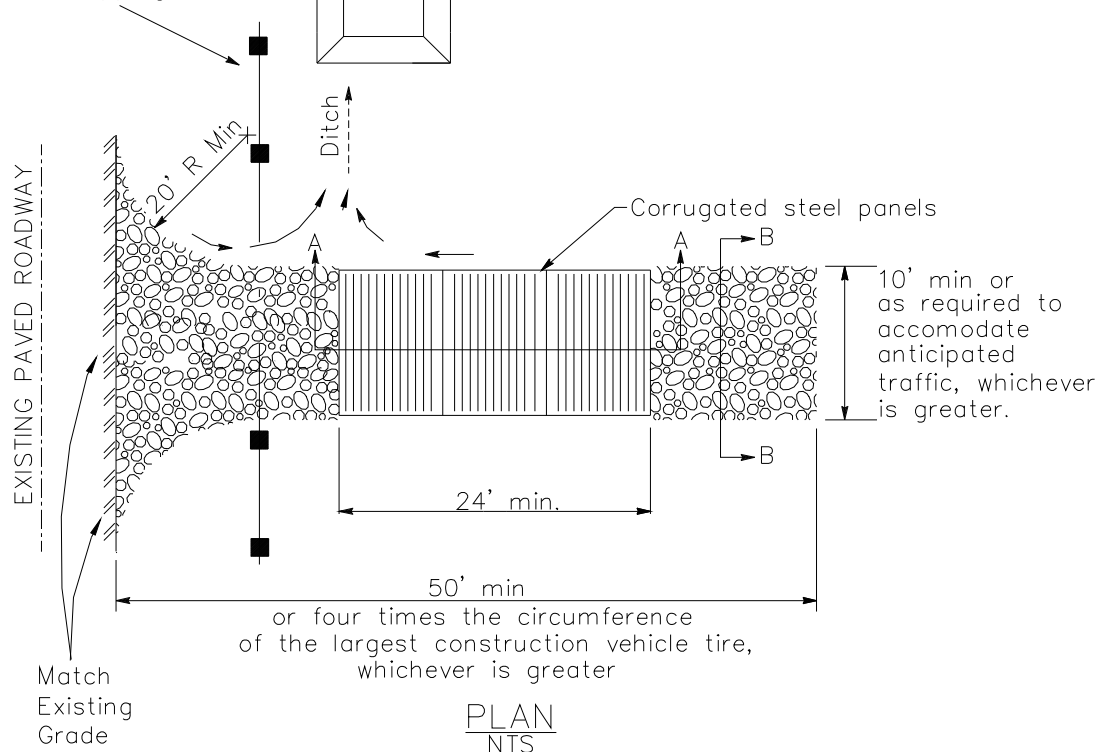

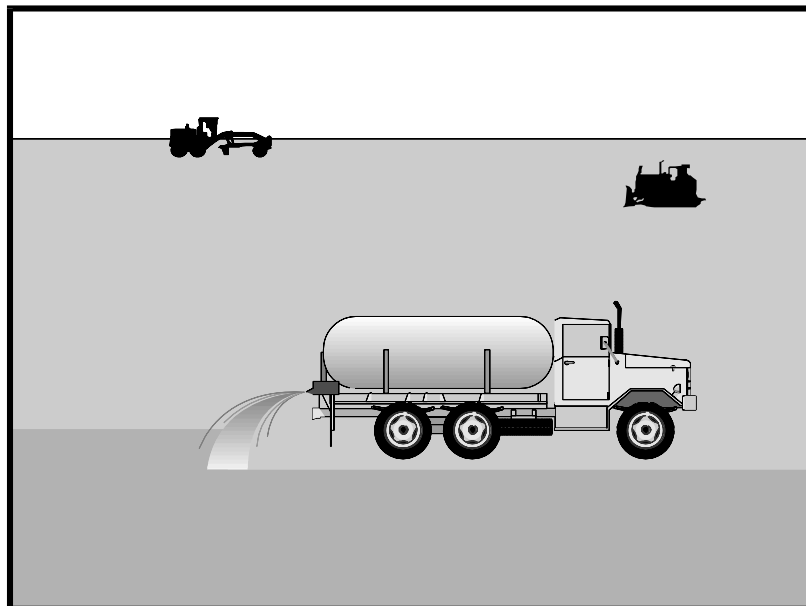

Description and Purpose

Wind erosion or dust control consists of applying water or other chemical dust suppressants as necessary to prevent or alleviate dust nuisance generated by construction activities. Covering small stockpiles or areas is an alternative to applying water or other dust palliatives.

California’s Mediterranean climate, with a short “wet” season and a typically long, hot “dry” season, allows the soils to thoroughly dry out. During the dry season, construction activities are at their peak, and disturbed and exposed areas are increasingly subject to wind erosion, sediment tracking and dust generated by construction equipment. Site conditions and climate can make dust control more of an erosion problem than water based erosion. Additionally, many local agencies, including Air Quality Management Districts, require dust control and/or dust control permits in order to comply with local nuisance laws, opacity laws (visibility impairment) and the requirements of the Clean Air Act. Wind erosion control is required to be implemented at all construction sites greater than 1 acre by the General Permit.

Suitable Applications

Most BMPs that provide protection against water-based erosion will also protect against wind-based erosion and dust control requirements required by other agencies will generally meet wind erosion control requirements for water quality protection. Wind erosion control BMPs are suitable during the following construction activities:

Categories

EC	Erosion Control	
SE	Sediment Control	<input checked="" type="checkbox"/>
TC	Tracking Control	
WE	Wind Erosion Control	<input checked="" type="checkbox"/>
NS	Non-Stormwater Management Control	
WM	Waste Management and Materials Pollution Control	

Legend:

- Primary Category
- Secondary Category

Targeted Constituents

Sediment	<input checked="" type="checkbox"/>
Nutrients	
Trash	
Metals	
Bacteria	
Oil and Grease	
Organics	

Potential Alternatives

EC-5 Soil Binders



- Construction vehicle traffic on unpaved roads
- Drilling and blasting activities
- Soils and debris storage piles
- Batch drop from front-end loaders
- Areas with unstabilized soil
- Final grading/site stabilization

Limitations

- Watering prevents dust only for a short period (generally less than a few hours) and should be applied daily (or more often) to be effective.
- Over watering may cause erosion and track-out.
- Oil or oil-treated subgrade should not be used for dust control because the oil may migrate into drainageways and/or seep into the soil.
- Chemical dust suppression agents may have potential environmental impacts. Selected chemical dust control agents should be environmentally benign.
- Effectiveness of controls depends on soil, temperature, humidity, wind velocity and traffic.
- Chemical dust suppression agents should not be used within 100 feet of wetlands or water bodies.
- Chemically treated subgrades may make the soil water repellent, interfering with long-term infiltration and the vegetation/re-vegetation of the site. Some chemical dust suppressants may be subject to freezing and may contain solvents and should be handled properly.
- In compacted areas, watering and other liquid dust control measures may wash sediment or other constituents into the drainage system.
- If the soil surface has minimal natural moisture, the affected area may need to be pre-wetted so that chemical dust control agents can uniformly penetrate the soil surface.

Implementation

Dust Control Practices

Dust control BMPs generally stabilize exposed surfaces and minimize activities that suspend or track dust particles. The following table presents dust control practices that can be applied to varying site conditions that could potentially cause dust. For heavily traveled and disturbed areas, wet suppression (watering), chemical dust suppression, gravel asphalt surfacing, temporary gravel construction entrances, equipment wash-out areas, and haul truck covers can be employed as dust control applications. Permanent or temporary vegetation and mulching can be employed for areas of occasional or no construction traffic. Preventive measures include minimizing surface areas to be disturbed, limiting onsite vehicle traffic to 15 mph or less, and controlling the number and activity of vehicles on a site at any given time.

Chemical dust suppressants include: mulch and fiber based dust palliatives (e.g. paper mulch with gypsum binder), salts and brines (e.g. calcium chloride, magnesium chloride), non-petroleum based organics (e.g. vegetable oil, lignosulfonate), petroleum based organics (e.g. asphalt emulsion, dust oils, petroleum resins), synthetic polymers (e.g. polyvinyl acetate, vinyls, acrylic), clay additives (e.g. bentonite, montmorillonite) and electrochemical products (e.g. enzymes, ionic products).

Site Condition	Dust Control Practices							
	Permanent Vegetation	Mulching	Wet Suppression (Watering)	Chemical Dust Suppression	Gravel or Asphalt	Temporary Gravel Construction Entrances/Equipment Wash Down	Synthetic Covers	Minimize Extent of Disturbed Area
Disturbed Areas not Subject to Traffic	X	X	X	X	X			X
Disturbed Areas Subject to Traffic			X	X	X	X		X
Material Stockpiles		X	X	X			X	X
Demolition			X			X	X	
Clearing/Excavation			X	X				X
Truck Traffic on Unpaved Roads			X	X	X	X	X	
Tracking					X	X		

Additional preventive measures include:

- Schedule construction activities to minimize exposed area (see EC-1, Scheduling).
- Quickly treat exposed soils using water, mulching, chemical dust suppressants, or stone/gravel layering.
- Identify and stabilize key access points prior to commencement of construction.
- Minimize the impact of dust by anticipating the direction of prevailing winds.
- Restrict construction traffic to stabilized roadways within the project site, as practicable.
- Water should be applied by means of pressure-type distributors or pipelines equipped with a spray system or hoses and nozzles that will ensure even distribution.
- All distribution equipment should be equipped with a positive means of shutoff.
- Unless water is applied by means of pipelines, at least one mobile unit should be available at all times to apply water or dust palliative to the project.
- If reclaimed waste water is used, the sources and discharge must meet California Department of Health Services water reclamation criteria and the Regional Water Quality

Control Board (RWQCB) requirements. Non-potable water should not be conveyed in tanks or drain pipes that will be used to convey potable water and there should be no connection between potable and non-potable supplies. Non-potable tanks, pipes, and other conveyances should be marked, "NON-POTABLE WATER - DO NOT DRINK."

- Pave or chemically stabilize access points where unpaved traffic surfaces adjoin paved roads.
- Provide covers for haul trucks transporting materials that contribute to dust.
- Provide for rapid clean up of sediments deposited on paved roads. Furnish stabilized construction road entrances and wheel wash areas.
- Stabilize inactive areas of construction sites using temporary vegetation or chemical stabilization methods.

For chemical stabilization, there are many products available for chemically stabilizing gravel roadways and stockpiles. If chemical stabilization is used, the chemicals should not create any adverse effects on stormwater, plant life, or groundwater and should meet all applicable regulatory requirements.

Costs

Installation costs for water and chemical dust suppression vary based on the method used and the length of effectiveness. Annual costs may be high since some of these measures are effective for only a few hours to a few days.

Inspection and Maintenance

- Inspect and verify that activity-based BMPs are in place prior to the commencement of associated activities.
- BMPs must be inspected in accordance with General Permit requirements for the associated project type and risk level. It is recommended that at a minimum, BMPs be inspected weekly, prior to forecasted rain events, daily during extended rain events, and after the conclusion of rain events.
- Check areas protected to ensure coverage.
- Most water-based dust control measures require frequent application, often daily or even multiple times per day. Obtain vendor or independent information on longevity of chemical dust suppressants.

References

Best Management Practices and Erosion Control Manual for Construction Sites, Flood Control District of Maricopa County, Arizona, September 1992.

California Air Pollution Control Laws, California Air Resources Board, updated annually.

Construction Manual, Chapter 4, Section 10, "Dust Control"; Section 17, "Watering"; and Section 18, "Dust Palliative", California Department of Transportation (Caltrans), July 2001.

Prospects for Attaining the State Ambient Air Quality Standards for Suspended Particulate Matter (PM₁₀), Visibility Reducing Particles, Sulfates, Lead, and Hydrogen Sulfide, California Air Resources Board, April 1991.

Stormwater Quality Handbooks Construction Site Best Management Practices (BMPs) Manual, State of California Department of Transportation (Caltrans), March 2003.

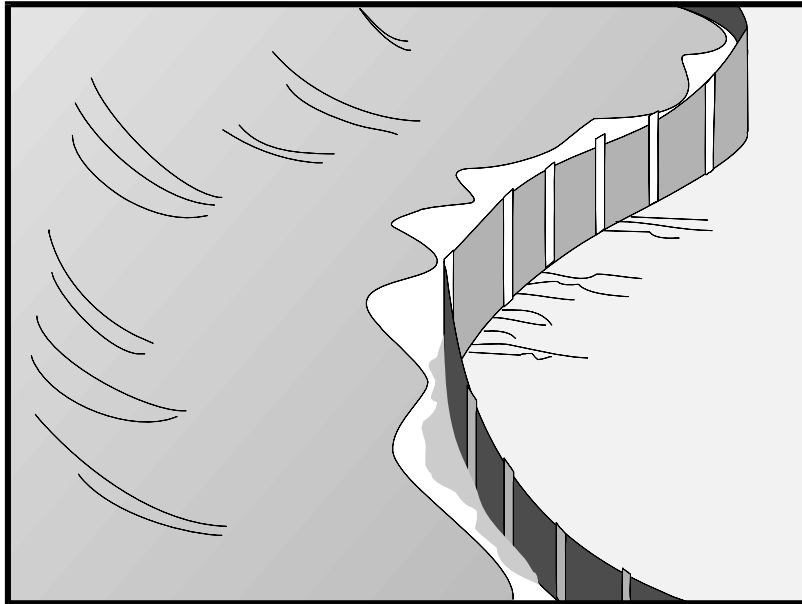

Description and Purpose

A silt fence is made of a woven geotextile that has been entrenched, attached to supporting poles, and sometimes backed by a plastic or wire mesh for support. The silt fence detains sediment-laden water, promoting sedimentation behind the fence.

Suitable Applications

Silt fences are suitable for perimeter control, placed below areas where sheet flows discharge from the site. They could also be used as interior controls below disturbed areas where runoff may occur in the form of sheet and rill erosion and around inlets within disturbed areas (SE-10). Silt fences are generally ineffective in locations where the flow is concentrated and are only applicable for sheet or overland flows. Silt fences are most effective when used in combination with erosion controls. Suitable applications include:

- Along the perimeter of a project.
- Below the toe or down slope of exposed and erodible slopes.
- Along streams and channels.
- Around temporary spoil areas and stockpiles.
- Around inlets.
- Below other small cleared areas.

Categories

EC	Erosion Control	
SE	Sediment Control	<input checked="" type="checkbox"/>
TC	Tracking Control	
WE	Wind Erosion Control	
NS	Non-Stormwater Management Control	
WM	Waste Management and Materials Pollution Control	

Legend:

- Primary Category**
- Secondary Category**

Targeted Constituents

Sediment	<input checked="" type="checkbox"/>
Nutrients	
Trash	
Metals	
Bacteria	
Oil and Grease	
Organics	

Potential Alternatives

- SE-5 Fiber Rolls
- SE-6 Gravel Bag Berm
- SE-8 Sandbag Barrier
- SE-10 Storm Drain Inlet Protection
- SE-14 Biofilter Bags



Limitations

- Do not use in streams, channels, drain inlets, or anywhere flow is concentrated.
- Do not use in locations where ponded water may cause a flooding hazard. Runoff typically ponds temporarily on the upstream side of silt fence.
- Do not use silt fence to divert water flows or place across any contour line. Fences not constructed on a level contour, or fences used to divert flow will concentrate flows resulting in additional erosion and possibly overtopping or failure of the silt fence.
- Improperly installed fences are subject to failure from undercutting, overtopping, or collapsing.
- Not effective unless trenched and keyed in.
- Not intended for use as mid-slope protection on slopes greater than 4:1 (H:V).
- Do not use on slopes subject to creeping, slumping, or landslides.

Implementation

General

A silt fence is a temporary sediment barrier consisting of woven geotextile stretched across and attached to supporting posts, trenched-in, and, depending upon the strength of fabric used, supported with plastic or wire mesh fence. Silt fences trap sediment by intercepting and detaining small amounts of sediment-laden runoff from disturbed areas in order to promote sedimentation behind the fence.

The following layout and installation guidance can improve performance and should be followed:

- Use principally in areas where sheet flow occurs.
- Install along a level contour, so water does not pond more than 1.5 ft at any point along the silt fence.
- The maximum length of slope draining to any point along the silt fence should be 200 ft or less.
- The maximum slope perpendicular to the fence line should be 1:1.
- Provide sufficient room for runoff to pond behind the fence and to allow sediment removal equipment to pass between the silt fence and toes of slopes or other obstructions. About 1200 ft² of ponding area should be provided for every acre draining to the fence.
- Turn the ends of the filter fence uphill to prevent stormwater from flowing around the fence.
- Leave an undisturbed or stabilized area immediately down slope from the fence where feasible.

- Silt fences should remain in place until the disturbed area is permanently stabilized, after which, the silt fence should be removed and properly disposed.
- Silt fence should be used in combination with erosion source controls up slope in order to provide the most effective sediment control.
- Be aware of local regulations regarding the type and installation requirements of silt fence, which may differ from those presented in this fact sheet.

Design and Layout

The fence should be supported by a plastic or wire mesh if the fabric selected does not have sufficient strength and bursting strength characteristics for the planned application (as recommended by the fabric manufacturer). Woven geotextile material should contain ultraviolet inhibitors and stabilizers to provide a minimum of six months of expected usable construction life at a temperature range of 0 °F to 120 °F.

- Layout in accordance with attached figures.
- For slopes steeper than 2:1 (H:V) and that contain a high number of rocks or large dirt clods that tend to dislodge, it may be necessary to install additional protection immediately adjacent to the bottom of the slope, prior to installing silt fence. Additional protection may be a chain link fence or a cable fence.
- For slopes adjacent to sensitive receiving waters or Environmentally Sensitive Areas (ESAs), silt fence should be used in conjunction with erosion control BMPs.

Standard vs. Heavy Duty Silt Fence

Standard Silt Fence

- Generally applicable in cases where the slope of area draining to the silt fence is 4:1 (H:V) or less.
- Used for shorter durations, typically 5 months or less
- Area draining to fence produces moderate sediment loads.

Heavy Duty Silt Fence

- Use is generally limited to 8 months or less.
- Area draining to fence produces moderate sediment loads.
- Heavy duty silt fence usually has 1 or more of the following characteristics, not possessed by standard silt fence.
 - Fence fabric has higher tensile strength.
 - Fabric is reinforced with wire backing or additional support.
 - Posts are spaced closer than pre-manufactured, standard silt fence products.
 - Posts are metal (steel or aluminum)

Materials

Standard Silt Fence

- Silt fence material should be woven geotextile with a minimum width of 36 in. and a minimum tensile strength of 100 lb force. The fabric should conform to the requirements in ASTM designation D4632 and should have an integral reinforcement layer. The

reinforcement layer should be a polypropylene, or equivalent, net provided by the manufacturer. The permittivity of the fabric should be between 0.1 sec^{-1} and 0.15 sec^{-1} in conformance with the requirements in ASTM designation D4491.

- Wood stakes should be commercial quality lumber of the size and shape shown on the plans. Each stake should be free from decay, splits or cracks longer than the thickness of the stake or other defects that would weaken the stakes and cause the stakes to be structurally unsuitable.
- Staples used to fasten the fence fabric to the stakes should be not less than 1.75 in. long and should be fabricated from 15 gauge or heavier wire. The wire used to fasten the tops of the stakes together when joining two sections of fence should be 9 gauge or heavier wire. Galvanizing of the fastening wire will not be required.

Heavy-Duty Silt Fence

- Some silt fence has a wire backing to provide additional support, and there are products that may use prefabricated plastic holders for the silt fence and use metal posts or bar reinforcement instead of wood stakes. If bar reinforcement is used in lieu of wood stakes, use number four or greater bar. Provide end protection for any exposed bar reinforcement for health and safety purposes.

Installation Guidelines – Traditional Method

Silt fences are to be constructed on a level contour. Sufficient area should exist behind the fence for ponding to occur without flooding or overtopping the fence.

- A trench should be excavated approximately 6 in. wide and 6 in. deep along the line of the proposed silt fence (trenches should not be excavated wider or deeper than necessary for proper silt fence installation).
- Bottom of the silt fence should be keyed-in a minimum of 12 in.
- Posts should be spaced a maximum of 6 ft apart and driven securely into the ground a minimum of 18 in. or 12 in. below the bottom of the trench.
- When standard strength geotextile is used, a plastic or wire mesh support fence should be fastened securely to the upslope side of posts using heavy-duty wire staples at least 1 in. long. The mesh should extend into the trench.
- When extra-strength geotextile and closer post spacing are used, the mesh support fence may be eliminated.
- Woven geotextile should be purchased in a long roll, then cut to the length of the barrier. When joints are necessary, geotextile should be spliced together only at a support post, with a minimum 6 in. overlap and both ends securely fastened to the post.
- The trench should be backfilled with native material and compacted.
- Construct silt fences with a setback of at least 3 ft from the toe of a slope. Where, due to specific site conditions, a 3 ft setback is not available, the silt fence may be constructed at the

toe of the slope, but should be constructed as far from the toe of the slope as practicable. Silt fences close to the toe of the slope will be less effective and more difficult to maintain.

- Construct the length of each reach so that the change in base elevation along the reach does not exceed $1/3$ the height of the barrier; in no case should the reach exceed 500 ft.
- Cross barriers should be a minimum of $1/3$ and a maximum of $1/2$ the height of the linear barrier.
- See typical installation details at the end of this fact sheet.

Installation Guidelines - Static Slicing Method

- Static Slicing is defined as insertion of a narrow blade pulled behind a tractor, similar to a plow blade, at least 10 inches into the soil while at the same time pulling silt geotextile fabric into the ground through the opening created by the blade to the depth of the blade. Once the geotextile is installed, the soil is compacted using tractor tires.
- This method will not work with pre-fabricated, wire backed silt fence.
- Benefits:
 - Ease of installation (most often done with a 2 person crew). In addition, installation using static slicing has been found to be more efficient on slopes, in rocky soils, and in saturated soils.
 - Minimal soil disturbance.
 - Greater level of compaction along fence, leading to higher performance (i.e. greater sediment retention).
 - Uniform installation.
 - Less susceptible to undercutting/undermining.

Costs

- It should be noted that costs vary greatly across regions due to available supplies and labor costs.
- Average annual cost for installation using the traditional silt fence installation method (assumes 6 month useful life) is \$7 per linear foot based on vendor research. Range of cost is \$3.50 - \$9.10 per linear foot.
- In tests, the slicing method required 0.33 man hours per 100 linear feet, while the trenched based systems required as much as 1.01 man hours per linear foot.

Inspection and Maintenance

- BMPs must be inspected in accordance with General Permit requirements for the associated project type and risk level. It is recommended that at a minimum, BMPs be inspected weekly, prior to forecasted rain events, daily during extended rain events, and after the conclusion of rain events.
- Repair undercut silt fences.

- Repair or replace split, torn, slumping, or weathered fabric. The lifespan of silt fence fabric is generally 5 to 8 months.
- Silt fences that are damaged and become unsuitable for the intended purpose should be removed from the site of work, disposed, and replaced with new silt fence barriers.
- Sediment that accumulates in the BMP should be periodically removed in order to maintain BMP effectiveness. Sediment should be removed when the sediment accumulation reaches one-third of the barrier height.
- Silt fences should be left in place until the upstream area is permanently stabilized. Until then, the silt fence should be inspected and maintained regularly.
- Remove silt fence when upgradient areas are stabilized. Fill and compact post holes and anchor trench, remove sediment accumulation, grade fence alignment to blend with adjacent ground, and stabilize disturbed area.

References

Manual of Standards of Erosion and Sediment Control Measures, Association of Bay Area Governments, May 1995.

National Management Measures to Control Nonpoint Source Pollution from Urban Areas, United States Environmental Protection Agency, 2002.

Proposed Guidance Specifying Management Measures for Sources of Nonpoint Pollution in Coastal Waters, Work Group-Working Paper, USEPA, April 1992.

Sedimentation and Erosion Control Practices, and Inventory of Current Practices (Draft), UESPA, 1990.

Southeastern Wisconsin Regional Planning Commission (SWRPC). Costs of Urban Nonpoint Source Water Pollution Control Measures. Technical Report No. 31. Southeastern Wisconsin Regional Planning Commission, Waukesha, WI. 1991

Stormwater Quality Handbooks - Construction Site Best Management Practices (BMPs) Manual, State of California Department of Transportation (Caltrans), March 2003.

Stormwater Management Manual for The Puget Sound Basin, Washington State Department of Ecology, Public Review Draft, 1991.

U.S. Environmental Protection Agency (USEPA). Stormwater Management for Industrial Activities: Developing Pollution Prevention Plans and Best Management Practices. U.S. Environmental Protection Agency, Office of Water, Washington, DC, 1992.

Water Quality Management Plan for the Lake Tahoe Region, Volume II, Handbook of Management Practices, Tahoe Regional Planning Agency, November 1988. Soil Stabilization BMP Research for Erosion and Sediment Controls: Cost Survey Technical Memorandum, State of California Department of Transportation (Caltrans), July 2007.

Erosion and Sediment Control Manual, Oregon Department of Environmental Quality, February 2005.

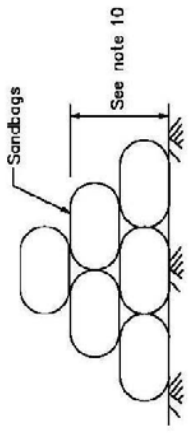
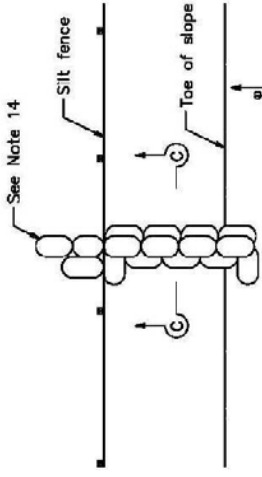
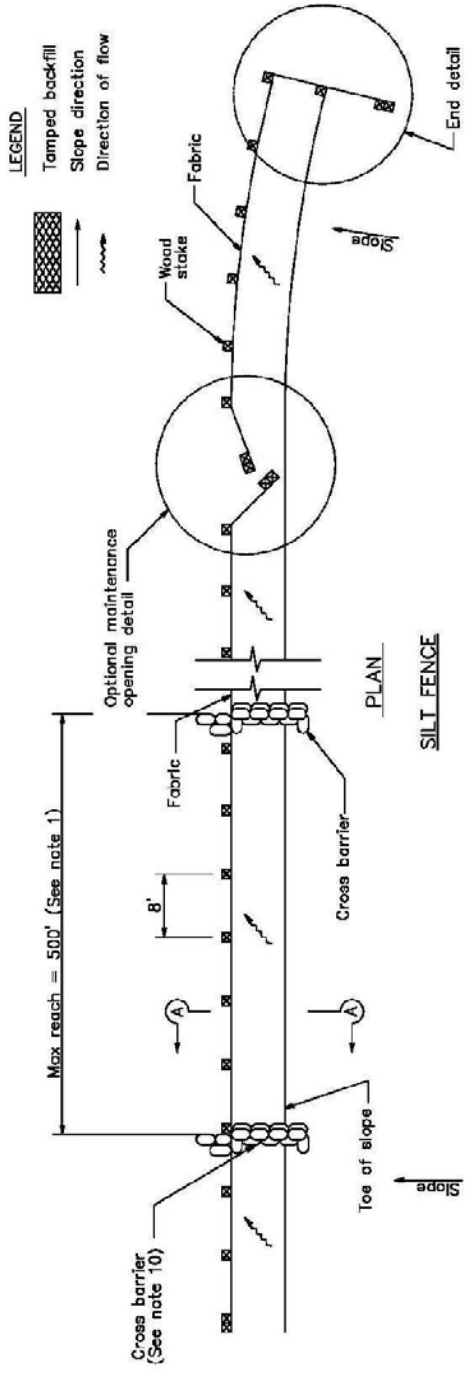

NOTES

1. Construct the length of each reach so that the change in base elevation along the reach does not exceed 1/3 the height of the linear barrier. In no case shall the reach length exceed 500'.
2. The last 8'-0" of fence shall be turned up slope.
3. Stake dimensions are nominal.
4. Dimension may vary to fit field condition.
5. Stakes shall be spaced at 8'-0" maximum and shall be positioned on downstream side of fence.
6. Stakes to overlap and fence fabric to fold around each stake one full turn. Secure fabric to stake with 4 staples.
7. Stakes shall be driven tightly together to prevent potential flow-through of sediment at joint. The tops of the stakes shall be secured with wire.
8. For end stake, fence fabric shall be folded around two stakes are full turn and secured with 4 staples.
9. Minimum 4 staples per stake. Dimensions shown are typical.
10. Cross barriers shall be a minimum of 1/3 and a maximum of 1/2 the height of the linear barrier.
11. Maintenance openings shall be constructed in a manner to ensure sediment remains behind silt fence.
12. Joining sections shall not be placed at sump locations.
13. Sandbag rows and layers shall be offset to eliminate gaps.
14. Add 3-4 bags to cross barrier on downgradient side of silt fence as needed to prevent bypass or undermining and as allowable based on site limits of disturbance.

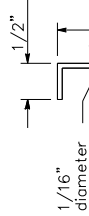

STAPLE DETAIL
(SEE NOTE 9)

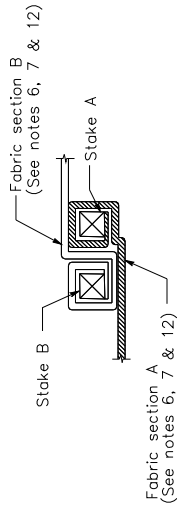

JOINING SECTION DETAIL (TOP VIEW)

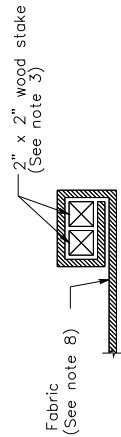

END STAKE DETAIL (TOP VIEW)

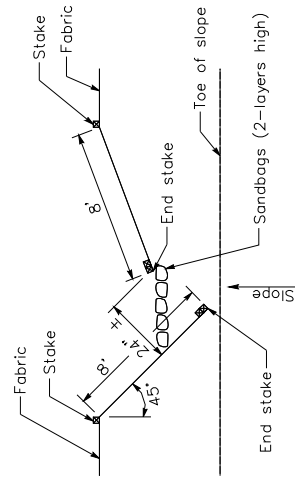

OPTIONAL MAINTENANCE OPENING DETAIL
(SEE NOTE 11)

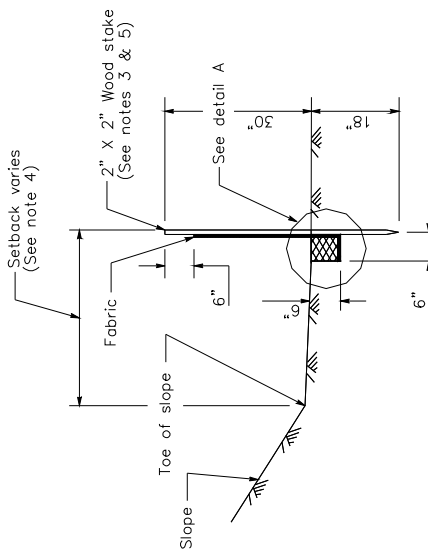

SECTION A-A

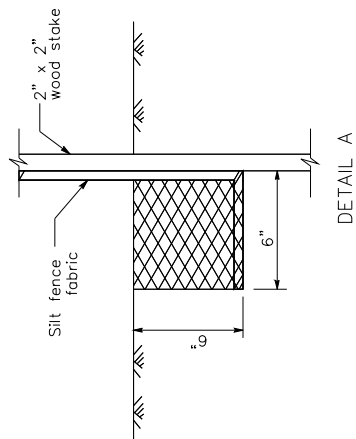

END DETAIL

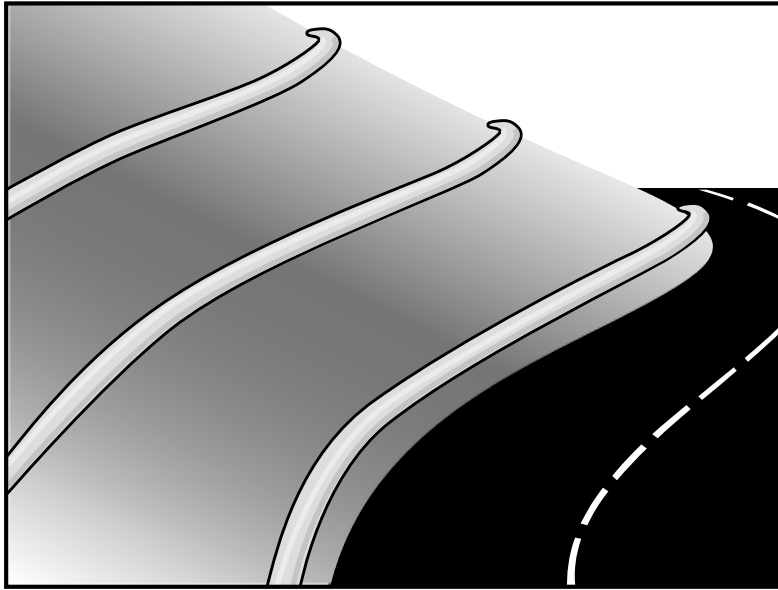

Description and Purpose

A fiber roll consists of straw, coir, or other biodegradable materials bound into a tight tubular roll wrapped by netting, which can be photodegradable or natural. Additionally, gravel core fiber rolls are available, which contain an imbedded ballast material such as gravel or sand for additional weight when staking the rolls are not feasible (such as use as inlet protection). When fiber rolls are placed at the toe and on the face of slopes along the contours, they intercept runoff, reduce its flow velocity, release the runoff as sheet flow, and provide removal of sediment from the runoff (through sedimentation). By interrupting the length of a slope, fiber rolls can also reduce sheet and rill erosion until vegetation is established.

Suitable Applications

Fiber rolls may be suitable:

- Along the toe, top, face, and at grade breaks of exposed and erodible slopes to shorten slope length and spread runoff as sheet flow.
- At the end of a downward slope where it transitions to a steeper slope.
- Along the perimeter of a project.
- As check dams in unlined ditches with minimal grade.
- Down-slope of exposed soil areas.
- At operational storm drains as a form of inlet protection.

Categories

EC	Erosion Control	<input checked="" type="checkbox"/>
SE	Sediment Control	<input checked="" type="checkbox"/>
TC	Tracking Control	
WE	Wind Erosion Control	
NS	Non-Stormwater Management Control	
WM	Waste Management and Materials Pollution Control	

Legend:

- Primary Category**
- Secondary Category**

Targeted Constituents

Sediment	<input checked="" type="checkbox"/>
Nutrients	
Trash	
Metals	
Bacteria	
Oil and Grease	
Organics	

Potential Alternatives

- SE-1 Silt Fence
- SE-6 Gravel Bag Berm
- SE-8 Sandbag Barrier
- SE-14 Biofilter Bags



- Around temporary stockpiles.

Limitations

- Fiber rolls are not effective unless trenched in and staked.
- Not intended for use in high flow situations.
- Difficult to move once saturated.
- If not properly staked and trenched in, fiber rolls could be transported by high flows.
- Fiber rolls have a very limited sediment capture zone.
- Fiber rolls should not be used on slopes subject to creep, slumping, or landslide.
- Rolls typically function for 12-24 months depending upon local conditions.

Implementation

Fiber Roll Materials

- Fiber rolls should be prefabricated.
- Fiber rolls may come manufactured containing polyacrylamide (PAM), a flocculating agent within the roll. Fiber rolls impregnated with PAM provide additional sediment removal capabilities and should be used in areas with fine, clayey or silty soils to provide additional sediment removal capabilities. Monitoring may be required for these installations.
- Fiber rolls are made from weed free rice straw, flax, or a similar agricultural material bound into a tight tubular roll by netting.
- Typical fiber rolls vary in diameter from 9 in. to 20 in. Larger diameter rolls are available as well.

Installation

- Locate fiber rolls on level contours spaced as follows:
 - Slope inclination of 4:1 (H:V) or flatter: Fiber rolls should be placed at a maximum interval of 20 ft.
 - Slope inclination between 4:1 and 2:1 (H:V): Fiber Rolls should be placed at a maximum interval of 15 ft. (a closer spacing is more effective).
 - Slope inclination 2:1 (H:V) or greater: Fiber Rolls should be placed at a maximum interval of 10 ft. (a closer spacing is more effective).
- Prepare the slope before beginning installation.
- Dig small trenches across the slope on the contour. The trench depth should be $\frac{1}{4}$ to $\frac{1}{3}$ of the thickness of the roll, and the width should equal the roll diameter, in order to provide area to backfill the trench.

- It is critical that rolls are installed perpendicular to water movement, and parallel to the slope contour.
- Start building trenches and installing rolls from the bottom of the slope and work up.
- It is recommended that pilot holes be driven through the fiber roll. Use a straight bar to drive holes through the roll and into the soil for the wooden stakes.
- Turn the ends of the fiber roll up slope to prevent runoff from going around the roll.
- Stake fiber rolls into the trench.
 - Drive stakes at the end of each fiber roll and spaced 4 ft maximum on center.
 - Use wood stakes with a nominal classification of 0.75 by 0.75 in. and minimum length of 24 in.
- If more than one fiber roll is placed in a row, the rolls should be overlapped, not abutted.
- See typical fiber roll installation details at the end of this fact sheet.

Removal

- Fiber rolls can be left in place or removed depending on the type of fiber roll and application (temporary vs. permanent installation). Typically, fiber rolls encased with plastic netting are used for a temporary application because the netting does not biodegrade. Fiber rolls used in a permanent application are typically encased with a biodegradable material and are left in place. Removal of a fiber roll used in a permanent application can result in greater disturbance.
- Temporary installations should only be removed when up gradient areas are stabilized per General Permit requirements, and/or pollutant sources no longer present a hazard. But, they should also be removed before vegetation becomes too mature so that the removal process does not disturb more soil and vegetation than is necessary.

Costs

Material costs for regular fiber rolls range from \$20 - \$30 per 25 ft roll.

Material costs for PAM impregnated fiber rolls range between 7.00-\$9.00 per linear foot, based upon vendor research.

Inspection and Maintenance

- BMPs must be inspected in accordance with General Permit requirements for the associated project type and risk level. It is recommended that at a minimum, BMPs be inspected weekly, prior to forecasted rain events, daily during extended rain events, and after the conclusion of rain events.
- Repair or replace split, torn, unraveling, or slumping fiber rolls.
- If the fiber roll is used as a sediment capture device, or as an erosion control device to maintain sheet flows, sediment that accumulates in the BMP should be periodically removed

in order to maintain BMP effectiveness. Sediment should be removed when sediment accumulation reaches one-third the designated sediment storage depth.

- If fiber rolls are used for erosion control, such as in a check dam, sediment removal should not be required as long as the system continues to control the grade. Sediment control BMPs will likely be required in conjunction with this type of application.
- Repair any rills or gullies promptly.

References

Stormwater Quality Handbooks - Construction Site Best Management Practices (BMPs) Manual, State of California Department of Transportation (Caltrans), March 2003.

Erosion and Sediment Control Manual, Oregon Department of Environmental Quality, February 2005.

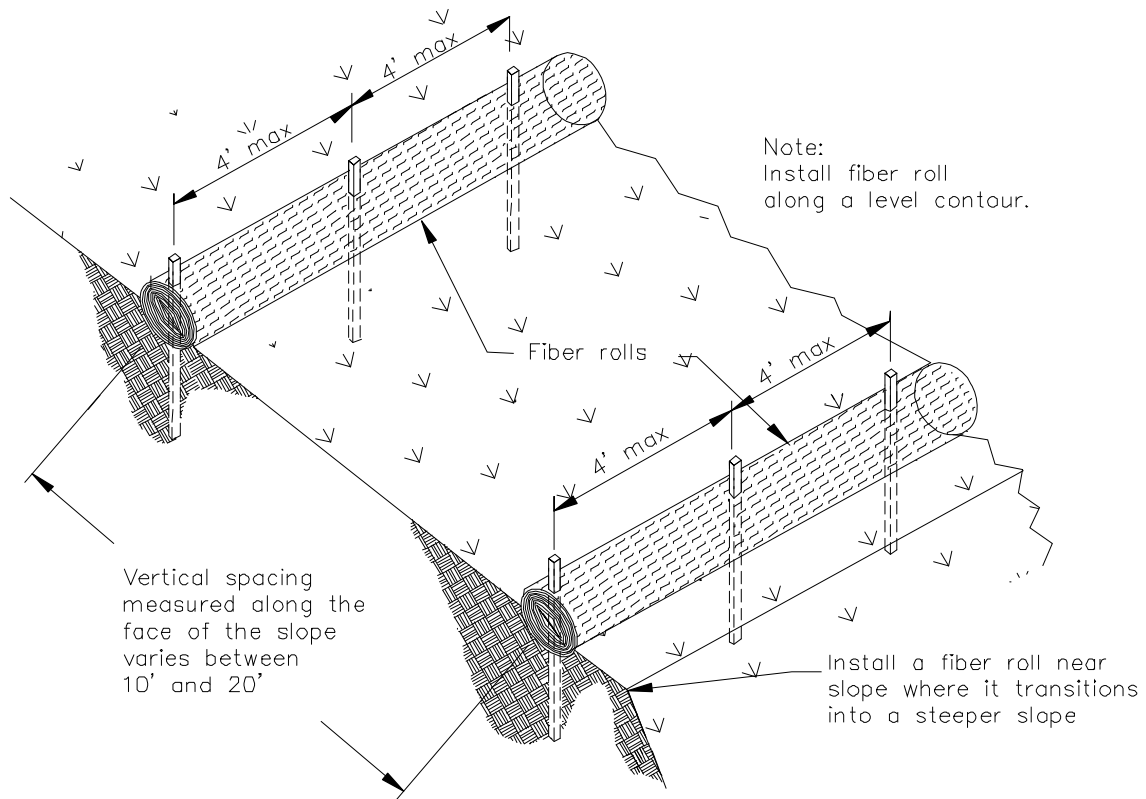

TYPICAL FIBER ROLL INSTALLATION

N.T.S.

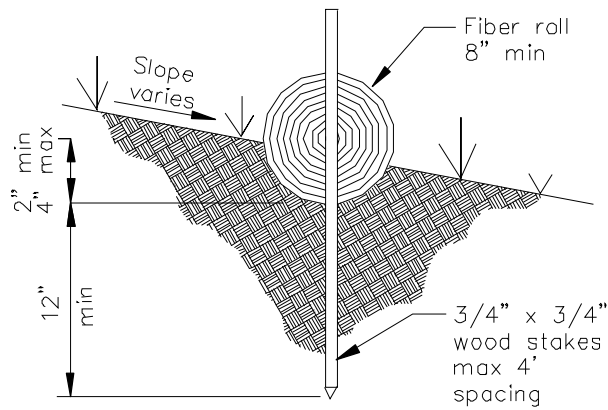

ENTRENCHMENT DETAIL

N.T.S.

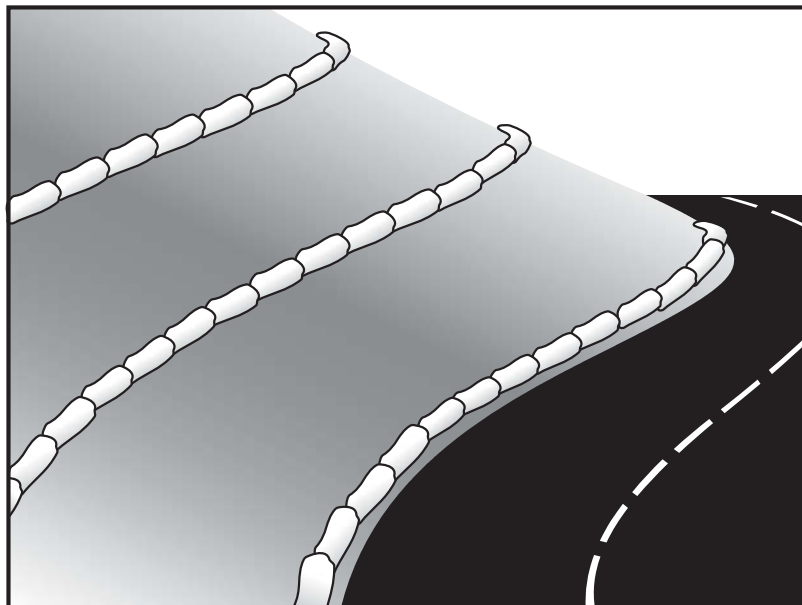

Description and Purpose

A gravel bag berm is a series of gravel-filled bags placed on a level contour to intercept sheet flows. Gravel bags pond sheet flow runoff, allowing sediment to settle out, and release runoff slowly as sheet flow, preventing erosion.

Suitable Applications

Gravel bag berms may be suitable:

- As a linear sediment control measure:
 - Below the toe of slopes and erodible slopes
 - As sediment traps at culvert/pipe outlets
 - Below other small cleared areas
 - Along the perimeter of a site
 - Down slope of exposed soil areas
 - Around temporary stockpiles and spoil areas
 - Parallel to a roadway to keep sediment off paved areas
 - Along streams and channels
- As a linear erosion control measure:
 - Along the face and at grade breaks of exposed and erodible slopes to shorten slope length and spread runoff as sheet flow.

Categories

EC	Erosion Control	<input checked="" type="checkbox"/>
SE	Sediment Control	<input checked="" type="checkbox"/>
TC	Tracking Control	
WE	Wind Erosion Control	
NS	Non-Stormwater Management Control	
WM	Waste Management and Materials Pollution Control	

Legend:

- Primary Category
- Secondary Category

Targeted Constituents

Sediment	<input checked="" type="checkbox"/>
Nutrients	
Trash	
Metals	
Bacteria	
Oil and Grease	
Organics	

Potential Alternatives

- SE-1 Silt Fence
- SE-5 Fiber Roll
- SE-8 Sandbag Barrier
- SE-14 Biofilter Bags



- At the top of slopes to divert runoff away from disturbed slopes.
- As chevrons (small check dams) across mildly sloped construction roads. For use check dam use in channels, see SE-4, Check Dams.

Limitations

- Gravel berms may be difficult to remove.
- Removal problems limit their usefulness in landscaped areas.
- Gravel bag berm may not be appropriate for drainage areas greater than 5 acres.
- Runoff will pond upstream of the berm, possibly causing flooding if sufficient space does not exist.
- Degraded gravel bags may rupture when removed, spilling contents.
- Installation can be labor intensive.
- Durability of gravel bags is somewhat limited and bags may need to be replaced when installation is required for longer than 6 months.
- Easily damaged by construction equipment.
- When used to detain concentrated flows, maintenance requirements increase.

Implementation

General

A gravel bag berm consists of a row of open graded gravel-filled bags placed on a level contour. When appropriately placed, a gravel bag berm intercepts and slows sheet flow runoff, causing temporary ponding. The temporary ponding allows sediment to settle. The open graded gravel in the bags is porous, which allows the ponded runoff to flow slowly through the bags, releasing the runoff as sheet flows. Gravel bag berms also interrupt the slope length and thereby reduce erosion by reducing the tendency of sheet flows to concentrate into rivulets, which erode rills, and ultimately gullies, into disturbed, sloped soils. Gravel bag berms are similar to sand bag barriers, but are more porous. Generally, gravel bag berms should be used in conjunction with temporary soil stabilization controls up slope to provide effective erosion and sediment control.

Design and Layout

- Locate gravel bag berms on level contours.
- When used for slope interruption, the following slope/sheet flow length combinations apply:
 - Slope inclination of 4:1 (H:V) or flatter: Gravel bags should be placed at a maximum interval of 20 ft, with the first row near the slope toe.
 - Slope inclination between 4:1 and 2:1 (H:V): Gravel bags should be placed at a maximum interval of 15 ft. (a closer spacing is more effective), with the first row near the slope toe.

Slope inclination 2:1 (H:V) or greater: Gravel bags should be placed at a maximum interval of 10 ft. (a closer spacing is more effective), with the first row near the slope toe.

- Turn the ends of the gravel bag barriers up slope to prevent runoff from going around the berm.
- Allow sufficient space up slope from the gravel bag berm to allow ponding, and to provide room for sediment storage.
- For installation near the toe of the slope, gravel bag barriers should be set back from the slope toe to facilitate cleaning. Where specific site conditions do not allow for a set-back, the gravel bag barrier may be constructed on the toe of the slope. To prevent flows behind the barrier, bags can be placed perpendicular to a berm to serve as cross barriers.
- Drainage area should not exceed 5 acres.
- In Non-Traffic Areas:
 - Height = 18 in. maximum
 - Top width = 24 in. minimum for three or more layer construction
 - Top width = 12 in. minimum for one or two layer construction
 - Side slopes = 2:1 (H:V) or flatter
- In Construction Traffic Areas:
 - Height = 12 in. maximum
 - Top width = 24 in. minimum for three or more layer construction.
 - Top width = 12 in. minimum for one or two layer construction.
 - Side slopes = 2:1 (H:V) or flatter.
- Butt ends of bags tightly.
- On multiple row, or multiple layer construction, overlap butt joints of adjacent row and row beneath.
- Use a pyramid approach when stacking bags.

Materials

- **Bag Material:** Bags should be woven polypropylene, polyethylene or polyamide fabric or burlap, minimum unit weight of 4 ounces/yd², Mullen burst strength exceeding 300 lb/in² in conformance with the requirements in ASTM designation D3786, and ultraviolet stability exceeding 70% in conformance with the requirements in ASTM designation D4355.

- **Bag Size:** Each gravel-filled bag should have a length of 18 in., width of 12 in., thickness of 3 in., and mass of approximately 33 lbs. Bag dimensions are nominal, and may vary based on locally available materials.
- **Fill Material:** Fill material should be 0.5 to 1 in. crushed rock, clean and free from clay, organic matter, and other deleterious material, or other suitable open graded, non-cohesive, porous gravel.

Costs

Material costs for gravel bags are average and are dependent upon material availability. \$2.50-3.00 per filled gravel bag is standard based upon vendor research.

Inspection and Maintenance

- BMPs must be inspected in accordance with General Permit requirements for the associated project type and risk level. It is recommended that at a minimum, BMPs be inspected weekly, prior to forecasted rain events, daily during extended rain events, and after the conclusion of rain events.
- Gravel bags exposed to sunlight will need to be replaced every two to three months due to degrading of the bags.
- Reshape or replace gravel bags as needed.
- Repair washouts or other damage as needed.
- Sediment that accumulates in the BMP should be periodically removed in order to maintain BMP effectiveness. Sediment should be removed when the sediment accumulation reaches one-third of the barrier height.
- Remove gravel bag berms when no longer needed and recycle gravel fill whenever possible and properly dispose of bag material. Remove sediment accumulation and clean, re-grade, and stabilize the area.

References

Handbook of Steel Drainage and Highway Construction, American Iron and Steel Institute, 1983.

Stormwater Quality Handbooks - Construction Site Best Management Practices (BMPs) Manual, State of California Department of Transportation (Caltrans), March 2003.

Stormwater Pollution Plan Handbook, First Edition, State of California, Department of Transportation Division of New Technology, Materials and Research, October 1992.

Erosion and Sediment Control Manual, Oregon Department of Environmental Quality, February 2005.



Description and Purpose

Street sweeping and vacuuming includes use of self-propelled and walk-behind equipment to remove sediment from streets and roadways, and to clean paved surfaces in preparation for final paving. Sweeping and vacuuming prevents sediment from the project site from entering storm drains or receiving waters.

Suitable Applications

Sweeping and vacuuming are suitable anywhere sediment is tracked from the project site onto public or private paved streets and roads, typically at points of egress. Sweeping and vacuuming are also applicable during preparation of paved surfaces for final paving.

Limitations

Sweeping and vacuuming may not be effective when sediment is wet or when tracked soil is caked (caked soil may need to be scraped loose).

Implementation

- Controlling the number of points where vehicles can leave the site will allow sweeping and vacuuming efforts to be focused, and perhaps save money.
- Inspect potential sediment tracking locations daily.
- Visible sediment tracking should be swept or vacuumed on a daily basis.
- Do not use kick brooms or sweeper attachments. These tend to spread the dirt rather than remove it.

Categories

EC	Erosion Control	
SE	Sediment Control	<input checked="" type="checkbox"/>
TC	Tracking Control	<input checked="" type="checkbox"/>
WE	Wind Erosion Control	
NS	Non-Stormwater Management Control	
WM	Waste Management and Materials Pollution Control	

Legend:

- Primary Objective
- Secondary Objective

Targeted Constituents

Sediment	<input checked="" type="checkbox"/>
Nutrients	
Trash	<input checked="" type="checkbox"/>
Metals	
Bacteria	
Oil and Grease	<input checked="" type="checkbox"/>
Organics	

Potential Alternatives

None



- If not mixed with debris or trash, consider incorporating the removed sediment back into the project

Costs

Rental rates for self-propelled sweepers vary depending on hopper size and duration of rental. Expect rental rates from \$58/hour (3 yd³ hopper) to \$88/hour (9 yd³ hopper), plus operator costs. Hourly production rates vary with the amount of area to be swept and amount of sediment. Match the hopper size to the area and expect sediment load to minimize time spent dumping.

Inspection and Maintenance

- Inspect BMPs prior to forecast rain, daily during extended rain events, after rain events, weekly during the rainy season, and at two-week intervals during the non-rainy season.
- When actively in use, points of ingress and egress must be inspected daily.
- When tracked or spilled sediment is observed outside the construction limits, it must be removed at least daily. More frequent removal, even continuous removal, may be required in some jurisdictions.
- Be careful not to sweep up any unknown substance or any object that may be potentially hazardous.
- Adjust brooms frequently; maximize efficiency of sweeping operations.
- After sweeping is finished, properly dispose of sweeper wastes at an approved dumpsite.

References

Stormwater Quality Handbooks - Construction Site Best Management Practices (BMPs) Manual, State of California Department of Transportation (Caltrans), November 2000.

Labor Surcharge and Equipment Rental Rates, State of California Department of Transportation (Caltrans), April 1, 2002 – March 31, 2003.

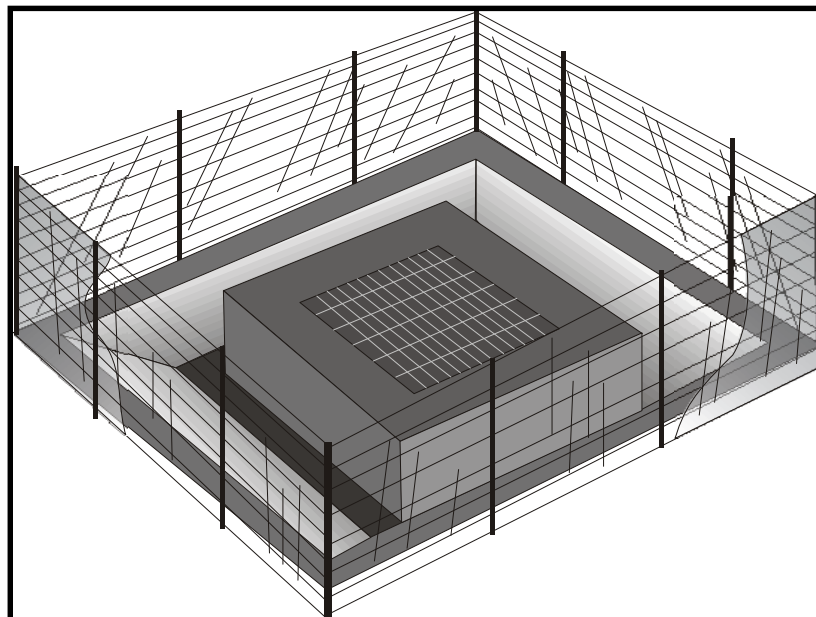

Description and Purpose

Storm drain inlet protection consists of a sediment filter or an impounding area in, around or upstream of a storm drain, drop inlet, or curb inlet. Storm drain inlet protection measures temporarily pond runoff before it enters the storm drain, allowing sediment to settle. Some filter configurations also remove sediment by filtering, but usually the ponding action results in the greatest sediment reduction. Temporary geotextile storm drain inserts attach underneath storm drain grates to capture and filter storm water.

Suitable Applications

Every storm drain inlet receiving runoff from unstabilized or otherwise active work areas should be protected. Inlet protection should be used in conjunction with other erosion and sediment controls to prevent sediment-laden stormwater and non-stormwater discharges from entering the storm drain system.

Limitations

- Drainage area should not exceed 1 acre.
- In general straw bales should not be used as inlet protection.
- Requires an adequate area for water to pond without encroaching into portions of the roadway subject to traffic.

Categories

EC	Erosion Control	
SE	Sediment Control	<input checked="" type="checkbox"/>
TC	Tracking Control	
WE	Wind Erosion Control	
NS	Non-Stormwater Management Control	
WM	Waste Management and Materials Pollution Control	

Legend:

- Primary Category
- Secondary Category

Targeted Constituents

Sediment	<input checked="" type="checkbox"/>
Nutrients	
Trash	<input checked="" type="checkbox"/>
Metals	
Bacteria	
Oil and Grease	
Organics	

Potential Alternatives

- SE-1 Silt Fence
- SE-5 Fiber Rolls
- SE-6 Gravel Bag Berm
- SE-8 Sandbag Barrier
- SE-14 Biofilter Bags



- Sediment removal may be inadequate to prevent sediment discharges in high flow conditions or if runoff is heavily sediment laden. If high flow conditions are expected, use other onsite sediment trapping techniques in conjunction with inlet protection.
- Frequent maintenance is required.
- Limit drainage area to 1 acre maximum. For drainage areas larger than 1 acre, runoff should be routed to a sediment-trapping device designed for larger flows. See BMPs SE-2, Sediment Basin, and SE-3, Sediment Traps.
- Excavated drop inlet sediment traps are appropriate where relatively heavy flows are expected, and overflow capability is needed.

Implementation

General

Inlet control measures presented in this handbook should not be used for inlets draining more than one acre. Runoff from larger disturbed areas should be first routed through SE-2, Sediment Basin or SE-3, Sediment Trap and/or used in conjunction with other drainage control, erosion control, and sediment control BMPs to protect the site. Different types of inlet protection are appropriate for different applications depending on site conditions and the type of inlet. Alternative methods are available in addition to the methods described/shown herein such as prefabricated inlet insert devices, or gutter protection devices.

Design and Layout

Identify existing and planned storm drain inlets that have the potential to receive sediment-laden surface runoff. Determine if storm drain inlet protection is needed and which method to use.

- The key to successful and safe use of storm drain inlet protection devices is to know where runoff that is directed toward the inlet to be protected will pond or be diverted as a result of installing the protection device.
 - Determine the acceptable location and extent of ponding in the vicinity of the drain inlet. The acceptable location and extent of ponding will influence the type and design of the storm drain inlet protection device.
 - Determine the extent of potential runoff diversion caused by the storm drain inlet protection device. Runoff ponded by inlet protection devices may flow around the device and towards the next downstream inlet. In some cases, this is acceptable; in other cases, serious erosion or downstream property damage can be caused by these diversions. The possibility of runoff diversions will influence whether or not storm drain inlet protection is suitable; and, if suitable, the type and design of the device.
- The location and extent of ponding, and the extent of diversion, can usually be controlled through appropriate placement of the inlet protection device. In some cases, moving the inlet protection device a short distance upstream of the actual inlet can provide more efficient sediment control, limit ponding to desired areas, and prevent or control diversions.

- Six types of inlet protection are presented below. However, it is recognized that other effective methods and proprietary devices exist and may be selected.
 - Silt Fence: Appropriate for drainage basins with less than a 5% slope, sheet flows, and flows under 0.5 cfs.
 - Excavated Drop Inlet Sediment Trap: An excavated area around the inlet to trap sediment (SE-3).
 - Gravel bag barrier: Used to create a small sediment trap upstream of inlets on sloped, paved streets. Appropriate for sheet flow or when concentrated flow may exceed 0.5 cfs, and where overtopping is required to prevent flooding.
 - Block and Gravel Filter: Appropriate for flows greater than 0.5 cfs.
 - Temporary Geotextile Storm drain Inserts: Different products provide different features. Refer to manufacturer details for targeted pollutants and additional features.
 - Biofilter Bag Barrier: Used to create a small retention area upstream of inlets and can be located on pavement or soil. Biofilter bags slowly filter runoff allowing sediment to settle out. Appropriate for flows under 0.5 cfs.
- Select the appropriate type of inlet protection and design as referred to or as described in this fact sheet.
- Provide area around the inlet for water to pond without flooding structures and property.
- Grates and spaces around all inlets should be sealed to prevent seepage of sediment-laden water.
- Excavate sediment sumps (where needed) 1 to 2 ft with 2:1 side slopes around the inlet.

Installation

- **DI Protection Type 1 - Silt Fence** - Similar to constructing a silt fence; see BMP SE-1, Silt Fence. Do not place fabric underneath the inlet grate since the collected sediment may fall into the drain inlet when the fabric is removed or replaced and water flow through the grate will be blocked resulting in flooding. See typical Type 1 installation details at the end of this fact sheet.
 1. Excavate a trench approximately 6 in. wide and 6 in. deep along the line of the silt fence inlet protection device.
 2. Place 2 in. by 2 in. wooden stakes around the perimeter of the inlet a maximum of 3 ft apart and drive them at least 18 in. into the ground or 12 in. below the bottom of the trench. The stakes should be at least 48 in.
 3. Lay fabric along bottom of trench, up side of trench, and then up stakes. See SE-1, Silt Fence, for details. The maximum silt fence height around the inlet is 24 in.
 4. Staple the filter fabric (for materials and specifications, see SE-1, Silt Fence) to wooden stakes. Use heavy-duty wire staples at least 1 in. in length.

5. Backfill the trench with gravel or compacted earth all the way around.
- **DI Protection Type 2 - Excavated Drop Inlet Sediment Trap** - Install filter fabric fence in accordance with DI Protection Type 1. Size excavated trap to provide a minimum storage capacity calculated at the rate 67 yd³/acre of drainage area. See typical Type 2 installation details at the end of this fact sheet.
 - **DI Protection Type 3 - Gravel bag** - Flow from a severe storm should not overtop the curb. In areas of high clay and silts, use filter fabric and gravel as additional filter media. Construct gravel bags in accordance with SE-6, Gravel Bag Berm. Gravel bags should be used due to their high permeability. See typical Type 3 installation details at the end of this fact sheet.
 1. Construct on gently sloping street.
 2. Leave room upstream of barrier for water to pond and sediment to settle.
 3. Place several layers of gravel bags – overlapping the bags and packing them tightly together.
 4. Leave gap of one bag on the top row to serve as a spillway. Flow from a severe storm (e.g., 10 year storm) should not overtop the curb.
 - **DI Protection Type 4 – Block and Gravel Filter** - Block and gravel filters are suitable for curb inlets commonly used in residential, commercial, and industrial construction. See typical Type 4 installation details at the end of this fact sheet.
 1. Place hardware cloth or comparable wire mesh with 0.5 in. openings over the drop inlet so that the wire extends a minimum of 1 ft beyond each side of the inlet structure. If more than one strip is necessary, overlap the strips. Place woven geotextile over the wire mesh.
 2. Place concrete blocks lengthwise on their sides in a single row around the perimeter of the inlet, so that the open ends face outward, not upward. The ends of adjacent blocks should abut. The height of the barrier can be varied, depending on design needs, by stacking combinations of blocks that are 4 in., 8 in., and 12 in. wide. The row of blocks should be at least 12 in. but no greater than 24 in. high.
 3. Place wire mesh over the outside vertical face (open end) of the concrete blocks to prevent stone from being washed through the blocks. Use hardware cloth or comparable wire mesh with 0.5 in. opening.
 4. Pile washed stone against the wire mesh to the top of the blocks. Use 0.75 to 3 in.
 - **DI Protection Type 5 – Temporary Geotextile Insert (proprietary)** – Many types of temporary inserts are available. Most inserts fit underneath the grate of a drop inlet or inside of a curb inlet and are fastened to the outside of the grate or curb. These inserts are removable and many can be cleaned and reused. Installation of these inserts differs between manufacturers. Please refer to manufacturer instruction for installation of proprietary devices.

- **DI Protection Type 6 - Biofilter bags** – Biofilter bags may be used as a substitute for gravel bags in low-flow situations. Biofilter bags should conform to specifications detailed in SE-14, Biofilter bags.
 1. Construct in a gently sloping area.
 2. Biofilter bags should be placed around inlets to intercept runoff flows.
 3. All bag joints should overlap by 6 in.
 4. Leave room upstream for water to pond and for sediment to settle out.
 5. Stake bags to the ground as described in the following detail. Stakes may be omitted if bags are placed on a paved surface.

Costs

- Average annual cost for installation and maintenance of DI Type 1-4 and 6 (one year useful life) is \$200 per inlet.
- Temporary geotextile inserts are proprietary and cost varies by region. These inserts can often be reused and may have greater than 1 year of use if maintained and kept undamaged. Average cost per insert ranges from \$50-75 plus installation, but costs can exceed \$100. This cost does not include maintenance.

Inspection and Maintenance

- BMPs must be inspected in accordance with General Permit requirements for the associated project type and risk level. It is recommended that at a minimum, BMPs be inspected weekly, prior to forecasted rain events, daily during extended rain events, and after the conclusion of rain events.
- Silt Fences. If the fabric becomes clogged, torn, or degrades, it should be replaced. Make sure the stakes are securely driven in the ground and are in good shape (i.e., not bent, cracked, or splintered, and are reasonably perpendicular to the ground). Replace damaged stakes. At a minimum, remove the sediment behind the fabric fence when accumulation reaches one-third the height of the fence or barrier height.
- Gravel Filters. If the gravel becomes clogged with sediment, it should be carefully removed from the inlet and either cleaned or replaced. Since cleaning gravel at a construction site may be difficult, consider using the sediment-laden stone as fill material and put fresh stone around the inlet. Inspect bags for holes, gashes, and snags, and replace bags as needed. Check gravel bags for proper arrangement and displacement.
- Sediment that accumulates in the BMP should be periodically removed in order to maintain BMP effectiveness. Sediment should be removed when the sediment accumulation reaches one-third of the barrier height.
- Inspect and maintain temporary geotextile insert devices according to manufacturer's specifications.
- Remove storm drain inlet protection once the drainage area is stabilized.

- Clean and regrade area around the inlet and clean the inside of the storm drain inlet, as it should be free of sediment and debris at the time of final inspection.

References

Stormwater Quality Handbooks - Construction Site Best Management Practices (BMPs) Manual, State of California Department of Transportation (Caltrans), March 2003.

Stormwater Management Manual for The Puget Sound Basin, Washington State Department of Ecology, Public Review Draft, 1991.

Erosion and Sediment Control Manual, Oregon Department of Environmental Quality, February 2005.

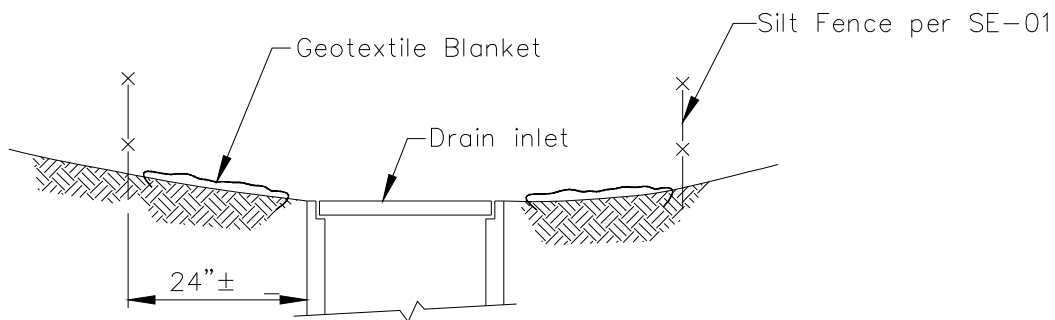

SECTION A-A

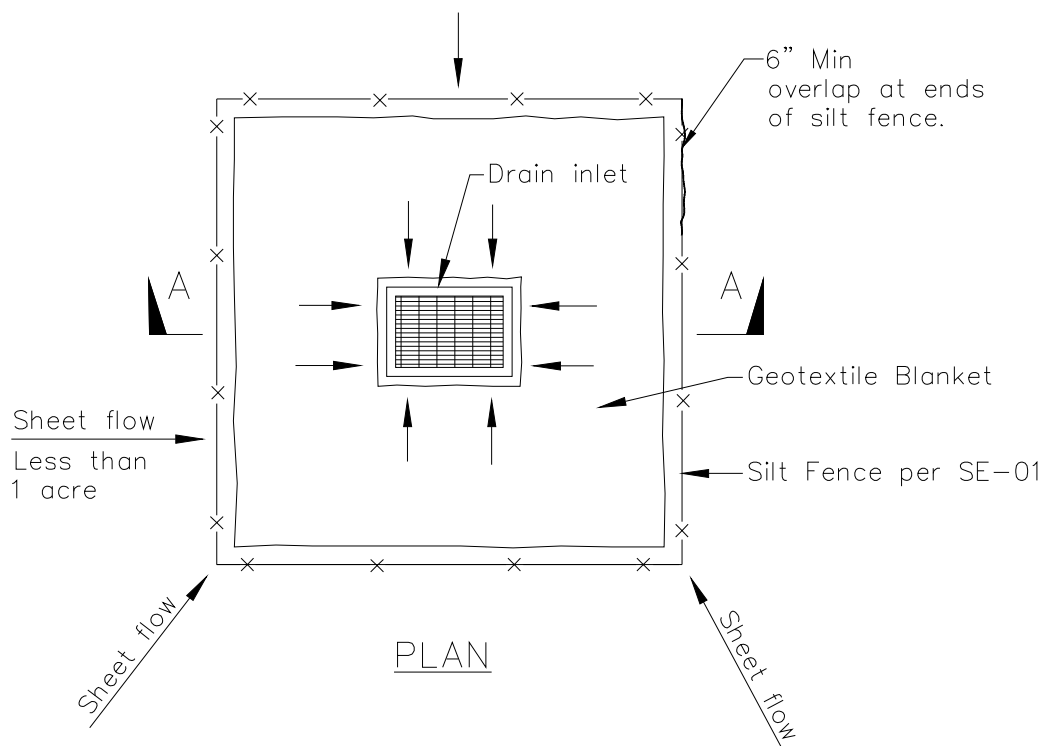

PLAN

DI PROTECTION TYPE 1
NOT TO SCALE

NOTES:

1. For use in areas where grading has been completed and final soil stabilization and seeding are pending.
2. Not applicable in paved areas.
3. Not applicable with concentrated flows.

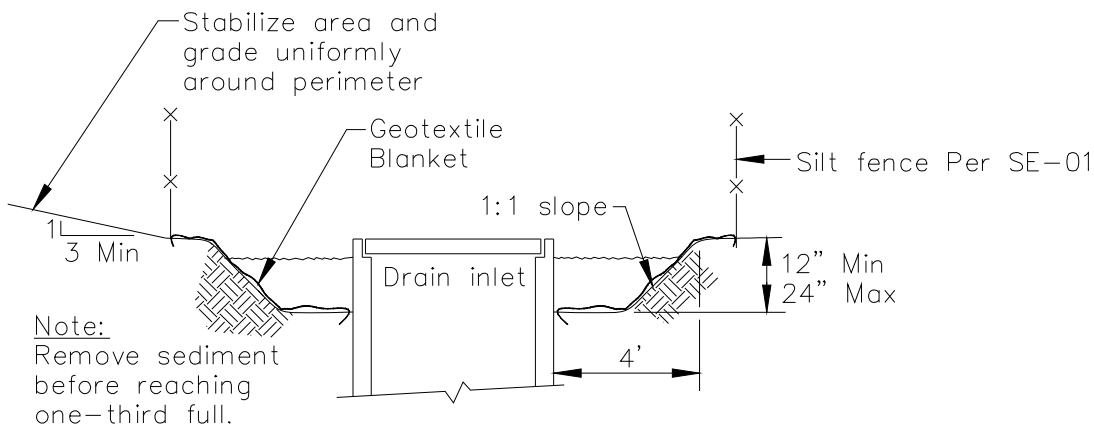

Section A-A

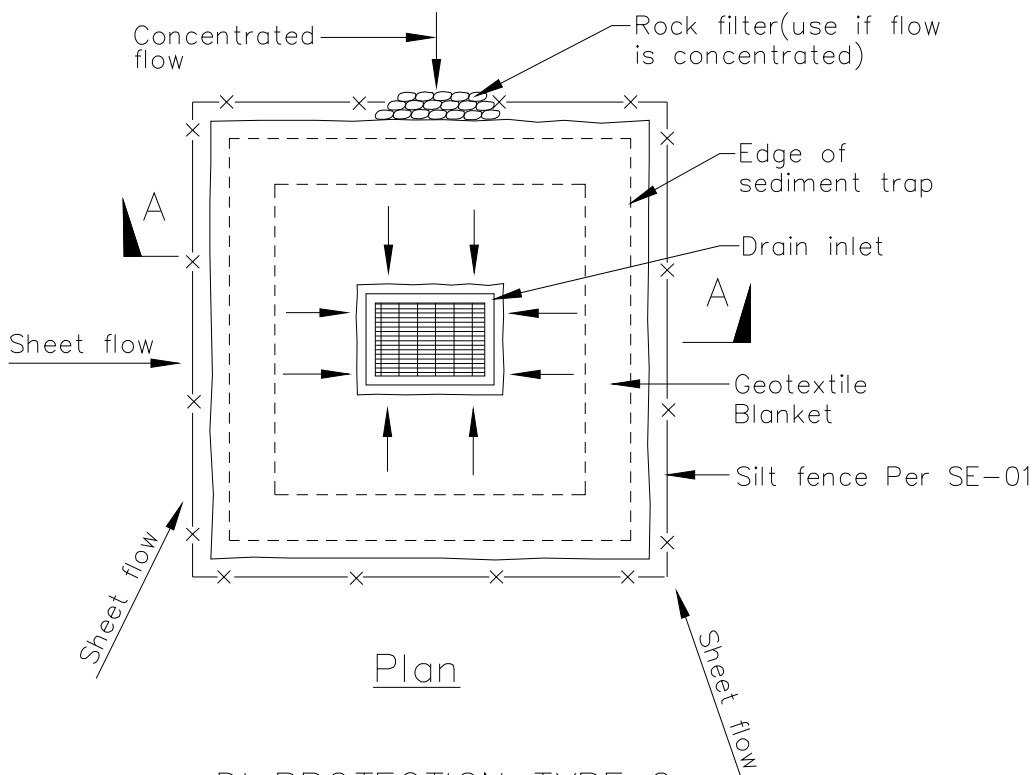

Plan

DI PROTECTION TYPE 2
NOT TO SCALE

Notes

1. For use in cleared and grubbed and in graded areas.
2. Shape basin so that longest inflow area faces longest length of trap.
3. For concentrated flows, shape basin in 2:1 ratio with length oriented towards direction of flow.

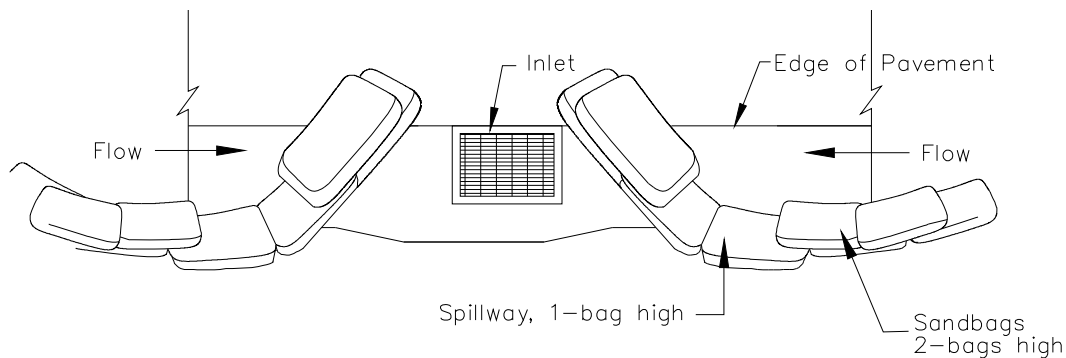

TYPICAL PROTECTION FOR INLET ON SUMP

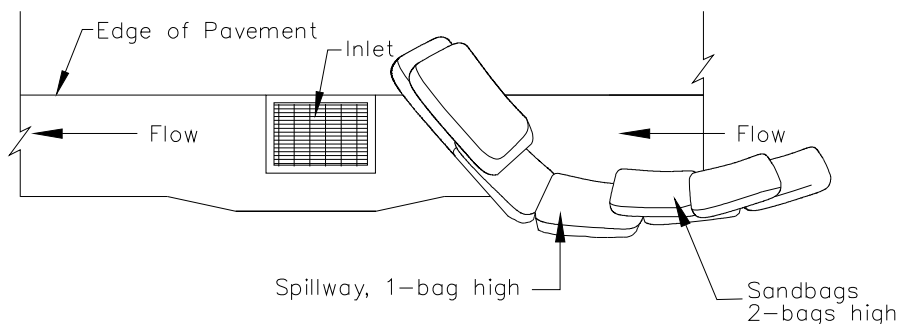

TYPICAL PROTECTION FOR INLET ON GRADE

NOTES:

1. Intended for short-term use.
2. Use to inhibit non-storm water flow.
3. Allow for proper maintenance and cleanup.
4. Bags must be removed after adjacent operation is completed
5. Not applicable in areas with high silts and clays without filter fabric.

DI PROTECTION TYPE 3
NOT TO SCALE

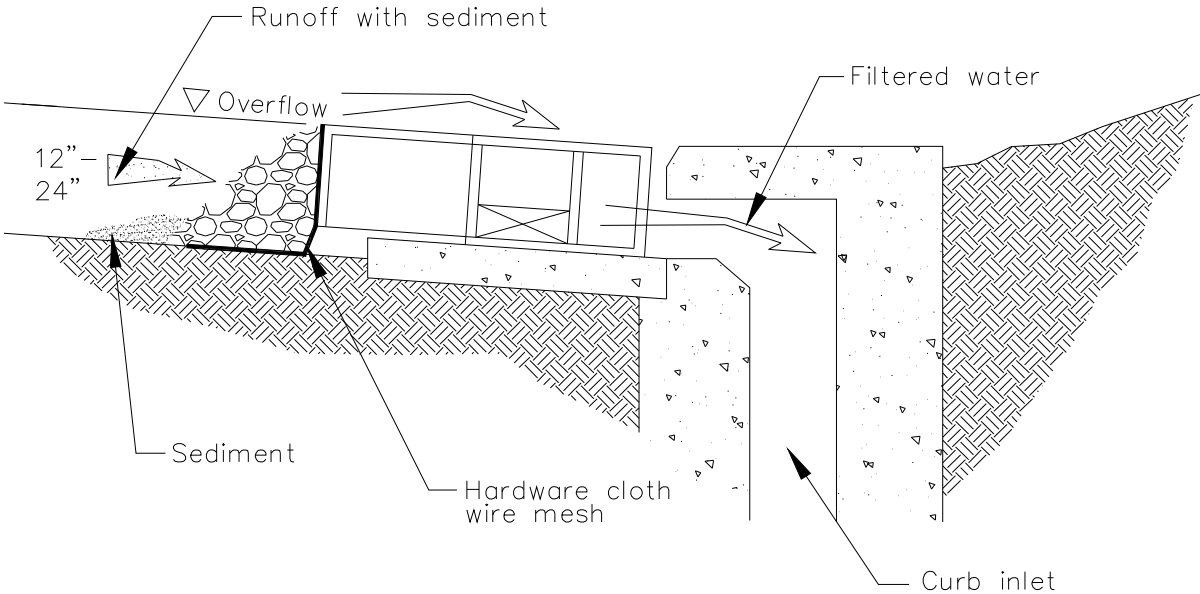
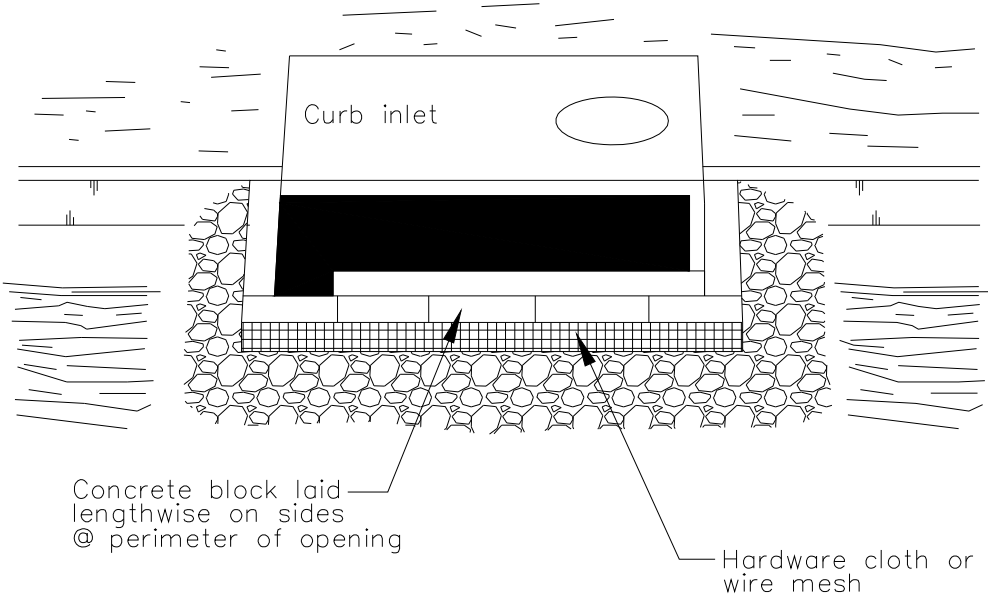

DI PROTECTION – TYPE 4
NOT TO SCALE

Section 4 Non-Stormwater Management and Material Management BMPs

4.1 Non-Stormwater Management BMPs

The [discharge](#) of materials other than [stormwater](#) and authorized [non-stormwater discharges](#) is prohibited by NPDES regulations as well as other local codes and ordinances. It is recognized that certain authorized non-stormwater discharges may be necessary for the completion of construction projects. Such discharges include but are not limited to irrigation of vegetative [erosion control](#) measures, and pipe flushing and testing.

Non-stormwater management [BMPs](#) are [source control BMPs](#) that prevent pollution by limiting or reducing potential [pollutants](#) at their source or eliminating off-site discharge. These practices involve day-to-day operations of the construction site and are usually under the control of the contractor. These BMPs are also referred to as “good housekeeping practices” which involve keeping a clean, orderly construction site.

Non-stormwater management BMPs also include procedures and practices designed to minimize or eliminate the discharge of pollutants from vehicle and equipment cleaning, fueling, and maintenance operations to stormwater drainage systems or to watercourses.

Table 4-1 lists the non-stormwater management BMPs. All these BMPs must be implemented depending on the conditions and applicability of deployment described as part of the BMP. The key to implementing these BMPs is to maintain a clean site and keep water, runoff, and run-on away from potential pollutants, including bare soil. In general, conduct construction activities so that: potential pollutants are not discharged directly to drainage systems; generation of potential pollutants is limited; and pollutants that are generated are contained and cleaned up immediately and are therefore not available for later discharge. These BMPs are fundamental to water quality protection and all sites must implement non-stormwater BMPs appropriate for the construction activities being performed.

It is recommended that owners and contractors be vigilant regarding implementation of these BMPs, including making their implementation a condition of continued employment, and part

Table 4-1 Non-Stormwater Management BMPs

BMP#	BMP Name
NS-1	Water Conservation Practices
NS-2	Dewatering Operations ¹
NS-3	Paving and Grinding Operations ¹
NS-4	Temporary Stream Crossing
NS-5	Clear Water Diversion
NS-6	Illicit Connection/Discharge
NS-7	Potable Water/Irrigation
NS-8	Vehicle and Equipment Cleaning
NS-9	Vehicle and Equipment Fueling
NS-10	Vehicle and Equipment Maintenance
NS-11	Pile Driving Operations
NS-12	Concrete Curing ¹
NS-13	Concrete Finishing ¹
NS-14	Material and Equipment Use
NS-15	Demolition Adjacent to Water
NS-16	Temporary Batch Plants ¹
1) BMP fact sheet updated in 2009	

of all prime and subcontract agreements. By doing so, the chance of inadvertent violation by an uncaring individual can be prevented, potentially saving thousands of dollars in fines and project delays. Also, if procedures are not properly implemented and/or if BMPs are compromised then the discharge may be subject to additional sampling and analysis requirements for non-visible pollutants contained in the [General Permit](#). (See section 2.5.5 of this handbook.)

4.2 Waste Management & Materials Pollution Control BMPs

[Waste management](#) and materials pollution control BMPs, like non-stormwater management BMPs, are source control BMPs that prevent pollution by limiting or reducing potential pollutants at their source before they come in contact with stormwater. These BMPs also involve day-to-day operations of the construction site, and are under the control of the contractor, and are additional “good housekeeping practices” which involve keeping a clean, orderly construction site. These BMPs are fundamental to water quality protection and all sites must implement waste management and/or materials pollution control non-stormwater BMPs appropriate for the construction activities being performed.

Waste management consists of implementing procedural and structural BMPs for handling, storing, and disposing of wastes generated by a construction project to prevent the release of waste materials into stormwater runoff or discharges through proper management of the following types of wastes:

- Solid
- Sanitary
- Concrete
- Hazardous
- Equipment-related wastes

Materials pollution control (also called materials handling) consists of implementing procedural and structural BMPs in the handling of, storing, and the using of construction materials. The BMPs are intended to prevent the release of pollutants during stormwater and non-stormwater discharges. The objective is to prevent or reduce the opportunity for contamination of stormwater runoff from construction materials by covering and/or providing [secondary containment](#) of storage areas and/or by taking adequate precautions when handling materials.

Table 4-2 Waste Management & Materials Pollution Control BMPs

BMP#	BMP Name
WM-1	Material Delivery and Storage ¹
WM-2	Material Use ¹
WM-3	Stockpile Management ¹
WM-4	Spill Prevention and Control
WM-5	Solid Waste Management
WM-6	Hazardous Waste Management
WM-7	Contaminated Soil Management
WM-8	Concrete Waste Management ¹
WM-9	Sanitary/ Septic Waste Management ¹
WM-10	Liquid Waste Management ¹
1) BMP fact sheet updated in 2009	

These controls must be implemented for all applicable activities, material usage, and site conditions. The discharge of construction materials or wastes from a site is prohibited.

Table 4-2 lists the waste management and materials pollution control BMPs. It is important to note that these BMPs should be implemented depending on the conditions/applicability of deployment described as part of the BMP.

4.3 Fact Sheet Format

A BMP fact sheet is a short document that presents detailed information about a particular BMP. Typically each fact sheet contains the information outlined in Figure 4-1. Completed fact sheets for each of the above activities are provided in Section 4.4.

The fact sheets also contain side bar presentations with information on BMP categories, targeted constituents, removal effectiveness, and potential alternatives.

4.4 BMP Fact Sheets

BMP Fact Sheets for non-stormwater management and waste management and materials pollution control follow. The BMP fact sheets are individually page numbered and are suitable for inclusions in SWPPPs.

Copies of the fact sheets can be individually downloaded from the CASQA BMP Handbook website at <http://www.casqa.org>.

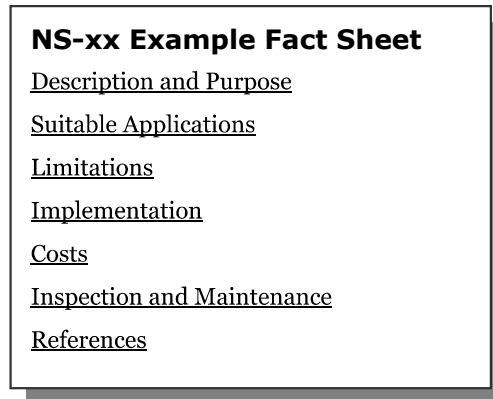
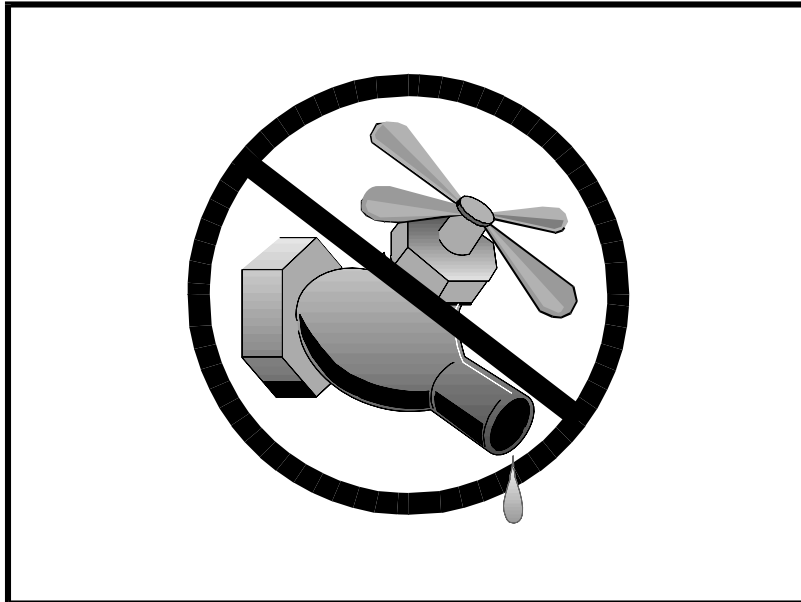

Figure 4-1
Example Fact Sheet



Description and Purpose

Water conservation practices are activities that use water during the construction of a project in a manner that avoids causing erosion and the transport of pollutants offsite. These practices can reduce or eliminate non-stormwater discharges.

Suitable Applications

Water conservation practices are suitable for all construction sites where water is used, including piped water, metered water, trucked water, and water from a reservoir.

Limitations

- None identified.

Implementation

- Keep water equipment in good working condition.
- Stabilize water truck filling area.
- Repair water leaks promptly.
- Washing of vehicles and equipment on the construction site is discouraged.
- Avoid using water to clean construction areas. If water must be used for cleaning or surface preparation, surface should be swept and vacuumed first to remove dirt. This will minimize amount of water required.
- Direct construction water runoff to areas where it can soak

Categories

EC	Erosion Control	<input checked="" type="checkbox"/>
SE	Sediment Control	<input checked="" type="checkbox"/>
TC	Tracking Control	
WE	Wind Erosion Control	
NS	Non-Stormwater Management Control	<input checked="" type="checkbox"/>
WM	Waste Management and Materials Pollution Control	

Legend:

- Primary Objective**
- Secondary Objective**

Targeted Constituents

Sediment	<input checked="" type="checkbox"/>
Nutrients	
Trash	
Metals	
Bacteria	
Oil and Grease	
Organics	

Potential Alternatives

None



into the ground or be collected and reused.

- Authorized non-stormwater discharges to the storm drain system, channels, or receiving waters are acceptable with the implementation of appropriate BMPs.
- Lock water tank valves to prevent unauthorized use.

Costs

The cost is small to none compared to the benefits of conserving water.

Inspection and Maintenance

- Inspect and verify that activity based BMPs are in place prior to the commencement of authorized non-stormwater discharges.
- Inspect BMPs subject to non-stormwater discharges daily while non-stormwater discharges are occurring.
- Repair water equipment as needed to prevent unintended discharges.
 - Water trucks
 - Water reservoirs (water buffalos)
 - Irrigation systems
 - Hydrant connections

References

Stormwater Quality Handbooks - Construction Site Best Management Practices (BMPs) Manual, State of California Department of Transportation (Caltrans), November 2000.

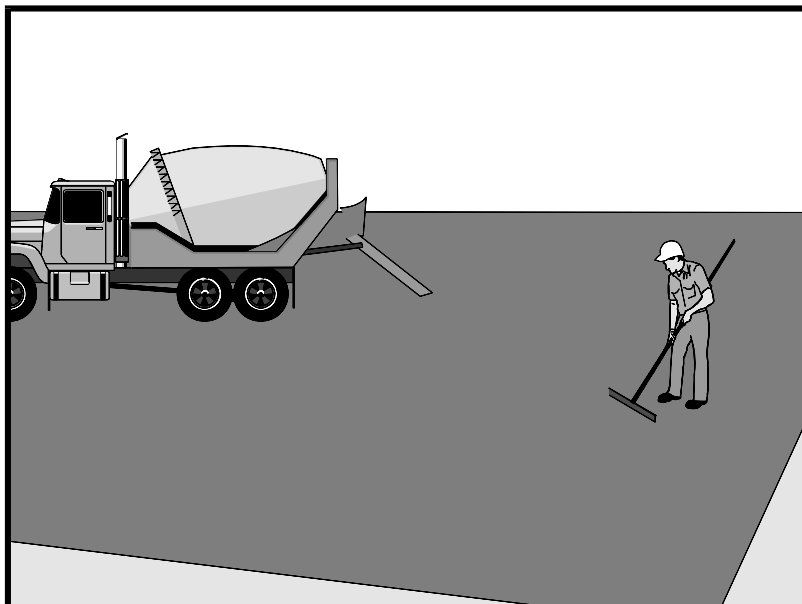

Categories

EC	Erosion Control	
SE	Sediment Control	
TC	Tracking Control	
WE	Wind Erosion Control	
NS	Non-Stormwater Management Control	<input checked="" type="checkbox"/>
WM	Waste Management and Materials Pollution Control	<input checked="" type="checkbox"/>

Legend:

- Primary Category
- Secondary Category

Targeted Constituents

Sediment	<input checked="" type="checkbox"/>
Nutrients	
Trash	
Metals	
Bacteria	
Oil and Grease	<input checked="" type="checkbox"/>
Organics	

Potential Alternatives

None

Description and Purpose

Prevent or reduce the discharge of pollutants from paving operations, using measures to prevent runoff and runoff pollution, properly disposing of wastes, and training employees and subcontractors.

The General Permit incorporates Numeric Effluent Limits (NEL) and Numeric Action Levels (NAL) for pH and turbidity (see Section 2 of this handbook to determine your project's risk level and if you are subject to these requirements).

Many types of construction materials associated with paving and grinding operations, including mortar, concrete, and cement and their associated wastes have basic chemical properties that can raise pH levels outside of the permitted range. Additional care should be taken when managing these materials to prevent them from coming into contact with stormwater flows, which could lead to exceedances of the General Permit requirements.

Suitable Applications

These procedures are implemented where paving, surfacing, resurfacing, or sawcutting, may pollute stormwater runoff or discharge to the storm drain system or watercourses.

Limitations

- Paving opportunities may be limited during wet weather.
- Discharges of freshly paved surfaces may raise pH to environmentally harmful levels and trigger permit violations.



Implementation

General

- Avoid paving during the wet season when feasible.
- Reschedule paving and grinding activities if rain is forecasted.
- Train employees and sub-contractors in pollution prevention and reduction.
- Store materials away from drainage courses to prevent stormwater runoff (see WM-1, Material Delivery and Storage).
- Protect drainage courses, particularly in areas with a grade, by employing BMPs to divert runoff or to trap and filter sediment.
- Stockpile material removed from roadways away from drain inlets, drainage ditches, and watercourses. These materials should be stored consistent with WM-3, Stockpile Management.
- Disposal of PCC (Portland cement concrete) and AC (asphalt concrete) waste should be in conformance with WM-8, Concrete Waste Management.

Saw Cutting, Grinding, and Pavement Removal

- Shovel or vacuum saw-cut slurry and remove from site. Cover or barricade storm drains during saw cutting to contain slurry.
- When paving involves AC, the following steps should be implemented to prevent the discharge of grinding residue, uncompacted or loose AC, tack coats, equipment cleaners, or unrelated paving materials:
 - AC grindings, pieces, or chunks used in embankments or shoulder backing should not be allowed to enter any storm drains or watercourses. Install inlet protection and perimeter controls until area is stabilized (i.e. cutting, grinding or other removal activities are complete and loose material has been properly removed and disposed of) or permanent controls are in place. Examples of temporary perimeter controls can be found in EC-9, Earth Dikes and Drainage Swales; SE-1, Silt Fence; SE-5, Fiber Rolls, or SE-13 Compost Socks and Berms
 - Collect and remove all broken asphalt and recycle when practical. Old or spilled asphalt should be recycled or disposed of properly.
- Do not allow saw-cut slurry to enter storm drains or watercourses. Residue from grinding operations should be picked up by a vacuum attachment to the grinding machine, or by sweeping, should not be allowed to flow across the pavement, and should not be left on the surface of the pavement. See also WM-8, Concrete Waste Management, and WM-10, Liquid Waste Management.
- Pavement removal activities should not be conducted in the rain.
- Collect removed pavement material by mechanical or manual methods. This material may be recycled for use as shoulder backing or base material.

- If removed pavement material cannot be recycled, transport the material back to an approved storage site.

Asphaltic Concrete Paving

- If paving involves asphaltic cement concrete, follow these steps:
 - Do not allow sand or gravel placed over new asphalt to wash into storm drains, streets, or creeks. Vacuum or sweep loose sand and gravel and properly dispose of this waste by referring to WM-5, Solid Waste Management.
 - Old asphalt should be disposed of properly. Collect and remove all broken asphalt from the site and recycle whenever possible.

Portland Cement Concrete Paving

- Do not wash sweepings from exposed aggregate concrete into a storm drain system. Collect waste materials by dry methods, such as sweeping or shoveling, and return to aggregate base stockpile or dispose of properly. Allow aggregate rinse to settle. Then, either allow rinse water to dry in a temporary pit as described in WM-8, Concrete Waste Management, or pump the water to the sanitary sewer if authorized by the local wastewater authority.

Sealing Operations

- During chip seal application and sweeping operations, petroleum or petroleum covered aggregate should not be allowed to enter any storm drain or water courses. Apply temporary perimeter controls until structure is stabilized (i.e. all sealing operations are complete and cured and loose materials have been properly removed and disposed).
- Inlet protection (SE-10, Storm Drain Inlet Protection) should be used during application of seal coat, tack coat, slurry seal, and fog seal.
- Seal coat, tack coat, slurry seal, or fog seal should not be applied if rainfall is predicted to occur during the application or curing period.

Paving Equipment

- Leaks and spills from paving equipment can contain toxic levels of heavy metals and oil and grease. Place drip pans or absorbent materials under paving equipment when not in use. Clean up spills with absorbent materials and dispose of in accordance with the applicable regulations. See NS-10, Vehicle and Equipment Maintenance, WM-4, Spill Prevention and Control, and WM-10, Liquid Waste Management.
- Substances used to coat asphalt transport trucks and asphalt spreading equipment should not contain soap and should be non-foaming and non-toxic.
- Paving equipment parked onsite should be parked over plastic to prevent soil contamination.
- Clean asphalt coated equipment offsite whenever possible. When cleaning dry, hardened asphalt from equipment, manage hardened asphalt debris as described in WM-5, Solid Waste Management. Any cleaning onsite should follow NS-8, Vehicle and Equipment Cleaning.

Thermoplastic Striping

- Thermoplastic striper and pre-heater equipment shutoff valves should be inspected to ensure that they are working properly to prevent leaking thermoplastic from entering drain inlets, the stormwater drainage system, or watercourses.
- Pre-heaters should be filled carefully to prevent splashing or spilling of hot thermoplastic. Leave six inches of space at the top of the pre-heater container when filling thermoplastic to allow room for material to move.
- Do not pre-heat, transfer, or load thermoplastic near drain inlets or watercourses.
- Clean truck beds daily of loose debris and melted thermoplastic. When possible, recycle thermoplastic material.

Raised/Recessed Pavement Marker Application and Removal

- Do not transfer or load bituminous material near drain inlets, the stormwater drainage system, or watercourses.
- Melting tanks should be loaded with care and not filled to beyond six inches from the top to leave room for splashing.
- When servicing or filling melting tanks, ensure all pressure is released before removing lids to avoid spills.
- On large-scale projects, use mechanical or manual methods to collect excess bituminous material from the roadway after removal of markers.

Costs

- All of the above are low cost measures.

Inspection and Maintenance

- Inspect and verify that activity-based BMPs are in place prior to the commencement of paving and grinding operations.
- BMPs must be inspected in accordance with General Permit requirements for the associated project type and risk level. It is recommended that at a minimum, BMPs be inspected weekly, prior to forecasted rain events, daily during extended rain events, and after the conclusion of rain events.
- Sample stormwater runoff required by the General Permit.
- Keep ample supplies of drip pans or absorbent materials onsite.
- Inspect and maintain machinery regularly to minimize leaks and drips.

References

Blueprint for a Clean Bay: Best Management Practices to Prevent Stormwater Pollution from Construction Related Activities; Santa Clara Valley Nonpoint Source Pollution Control Program, 1995.

Hot Mix Asphalt-Paving Handbook AC 150/5370-14, Appendix I, U.S. Army Corps of Engineers, July 1991.

Stormwater Quality Handbooks - Construction Site Best Management Practices (BMPs) Manual, State of California Department of Transportation (Caltrans), March 2003.

Erosion and Sediment Control Manual, Oregon Department of Environmental Quality, February 2005.

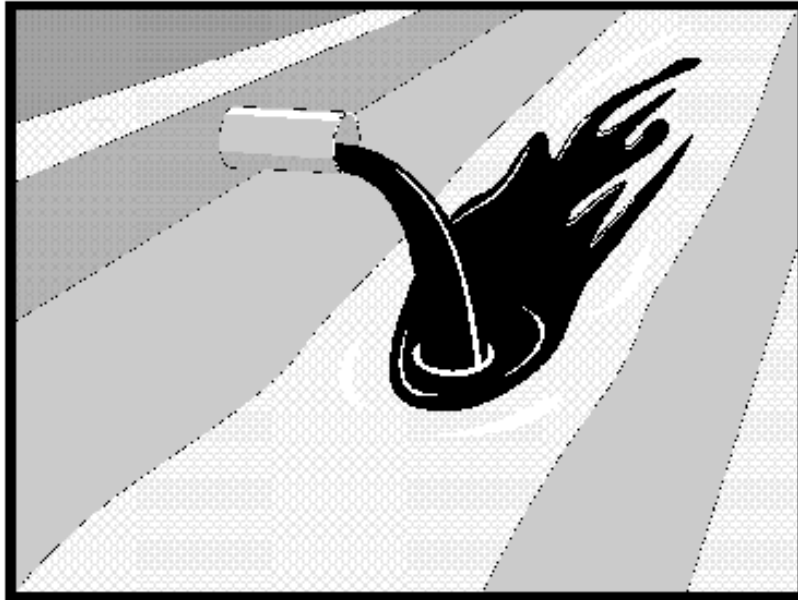

Description and Purpose

Procedures and practices designed for construction contractors to recognize illicit connections or illegally dumped or discharged materials on a construction site and report incidents.

Suitable Applications

This best management practice (BMP) applies to all construction projects. Illicit connection/discharge and reporting is applicable anytime an illicit connection or discharge is discovered or illegally dumped material is found on the construction site.

Limitations

Illicit connections and illegal discharges or dumping, for the purposes of this BMP, refer to discharges and dumping caused by parties other than the contractor. If pre-existing hazardous materials or wastes are known to exist onsite, they should be identified in the SWPPP and handled as set forth in the SWPPP.

Implementation

Planning

- Review the SWPPP. Pre-existing areas of contamination should be identified and documented in the SWPPP.
- Inspect site before beginning the job for evidence of illicit connections, illegal dumping or discharges. Document any pre-existing conditions and notify the owner.
- Inspect site regularly during project execution for evidence

Categories

EC	Erosion Control	
SE	Sediment Control	
TC	Tracking Control	
WE	Wind Erosion Control	
NS	Non-Stormwater Management Control	<input checked="" type="checkbox"/>
WM	Waste Management and Materials Pollution Control	

Legend:

- Primary Objective
- Secondary Objective

Targeted Constituents

Sediment	
Nutrients	<input checked="" type="checkbox"/>
Trash	<input checked="" type="checkbox"/>
Metals	<input checked="" type="checkbox"/>
Bacteria	<input checked="" type="checkbox"/>
Oil and Grease	<input checked="" type="checkbox"/>
Organics	<input checked="" type="checkbox"/>

Potential Alternatives

None



of illicit connections, illegal dumping or discharges.

- Observe site perimeter for evidence for potential of illicitly discharged or illegally dumped material, which may enter the job site.

Identification of Illicit Connections and Illegal Dumping or Discharges

- **General** – unlabeled and unidentifiable material should be treated as hazardous.
- **Solids** - Look for debris, or rubbish piles. Solid waste dumping often occurs on roadways with light traffic loads or in areas not easily visible from the traveled way.
- **Liquids** - signs of illegal liquid dumping or discharge can include:
 - Visible signs of staining or unusual colors to the pavement or surrounding adjacent soils
 - Pungent odors coming from the drainage systems
 - Discoloration or oily substances in the water or stains and residues detained within ditches, channels or drain boxes
 - Abnormal water flow during the dry weather season
- **Urban Areas** - Evidence of illicit connections or illegal discharges is typically detected at storm drain outfall locations or at manholes. Signs of an illicit connection or illegal discharge can include:
 - Abnormal water flow during the dry weather season
 - Unusual flows in sub drain systems used for dewatering
 - Pungent odors coming from the drainage systems
 - Discoloration or oily substances in the water or stains and residues detained within ditches, channels or drain boxes
 - Excessive sediment deposits, particularly adjacent to or near active offsite construction projects
- **Rural Areas** - Illicit connections or illegal discharges involving irrigation drainage ditches are detected by visual inspections. Signs of an illicit discharge can include:
 - Abnormal water flow during the non-irrigation season
 - Non-standard junction structures
 - Broken concrete or other disturbances at or near junction structures

Reporting

Notify the owner of any illicit connections and illegal dumping or discharge incidents at the time of discovery. For illicit connections or discharges to the storm drain system, notify the local stormwater management agency. For illegal dumping, notify the local law enforcement agency.

Cleanup and Removal

The responsibility for cleanup and removal of illicit or illegal dumping or discharges will vary by location. Contact the local stormwater management agency for further information.

Costs

Costs to look for and report illicit connections and illegal discharges and dumping are low. The best way to avoid costs associated with illicit connections and illegal discharges and dumping is to keep the project perimeters secure to prevent access to the site, to observe the site for vehicles that should not be there, and to document any waste or hazardous materials that exist onsite before taking possession of the site.

Inspection and Maintenance

- Inspect and verify that activity-based BMPs are in place prior to the commencement of associated activities. While activities associated with the BMP are under way, inspect weekly during the rainy season and at two-week intervals in the non-rainy season to verify continued BMP implementation.
- Inspect the site regularly to check for any illegal dumping or discharge.
- Prohibit employees and subcontractors from disposing of non-job related debris or materials at the construction site.
- Notify the owner of any illicit connections and illegal dumping or discharge incidents at the time of discovery.

References

Blueprint for a Clean Bay: Best Management Practices to Prevent Stormwater Pollution from Construction Related Activities; Santa Clara Valley Nonpoint Source Pollution Control Program, 1995.

Stormwater Quality Handbooks - Construction Site Best Management Practices (BMPs) Manual, State of California Department of Transportation (Caltrans), November 2000.

Stormwater Management for Construction Activities, Developing Pollution Prevention Plans and Best Management Practices, EPA 832-R-92005; USEPA, April 1992.

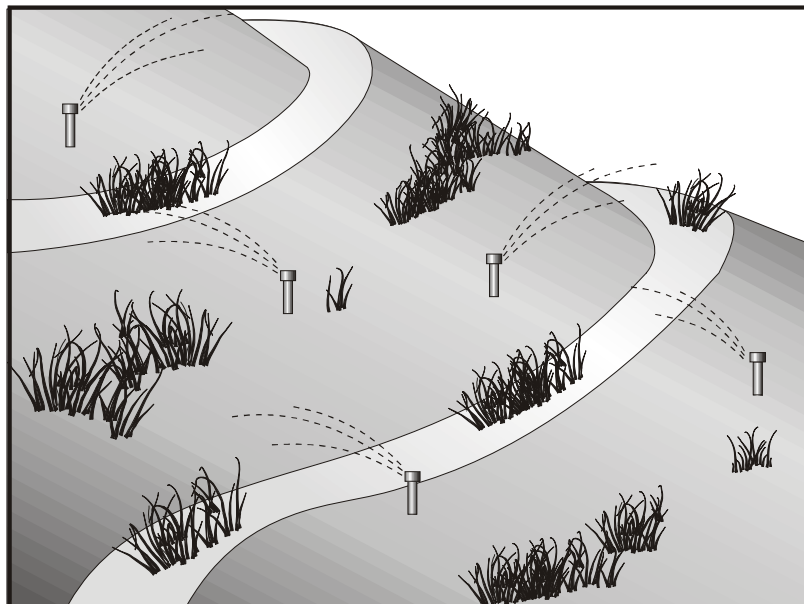

Description and Purpose

Potable Water/Irrigation consists of practices and procedures to manage the discharge of potential pollutants generated during discharges from irrigation water lines, landscape irrigation, lawn or garden watering, planned and unplanned discharges from potable water sources, water line flushing, and hydrant flushing.

Suitable Applications

Implement this BMP whenever potable water or irrigation water discharges occur at or enter a construction site.

Limitations

None identified.

Implementation

- Direct water from offsite sources around or through a construction site, where feasible, in a way that minimizes contact with the construction site.
- Discharges from water line flushing should be reused for landscaping purposes where feasible.
- Shut off the water source to broken lines, sprinklers, or valves as soon as possible to prevent excess water flow.
- Protect downstream stormwater drainage systems and watercourses from water pumped or bailed from trenches excavated to repair water lines.
- Inspect irrigated areas within the construction limits for

Categories

EC	Erosion Control	
SE	Sediment Control	
TC	Tracking Control	
WE	Wind Erosion Control	
NS	Non-Stormwater Management Control	<input checked="" type="checkbox"/>
WM	Waste Management and Materials Pollution Control	

Legend:

- Primary Objective
- Secondary Objective

Targeted Constituents

Sediment	<input checked="" type="checkbox"/>
Nutrients	<input checked="" type="checkbox"/>
Trash	
Metals	<input checked="" type="checkbox"/>
Bacteria	
Oil and Grease	
Organics	<input checked="" type="checkbox"/>

Potential Alternatives

None



excess watering. Adjust watering times and schedules to ensure that the appropriate amount of water is being used and to minimize runoff. Consider factors such as soil structure, grade, time of year, and type of plant material in determining the proper amounts of water for a specific area.

Costs

Cost to manage potable water and irrigation are low and generally considered to be a normal part of related activities.

Inspection and Maintenance

- Inspect and verify that activity-based BMPs are in place prior to the commencement of associated activities. While activities associated with the BMP are under way, inspect weekly during the rainy season and at two-week intervals in the non-rainy season to verify continued BMP implementation.
- Inspect BMPs subject to non-stormwater discharges daily while non-stormwater discharges occur.
- Repair broken water lines as soon as possible.
- Inspect irrigated areas regularly for signs of erosion and/or discharge.

References

Blueprint for a Clean Bay: Best Management Practices to Prevent Stormwater Pollution from Construction Related Activities; Santa Clara Valley Nonpoint Source Pollution Control Program, 1995.

Stormwater Quality Handbooks - Construction Site Best Management Practices (BMPs) Manual, State of California Department of Transportation (Caltrans), November 2000.

Stormwater Management for Construction Activities, Developing Pollution Prevention Plans and Best Management Practices, EPA 832-R-92005; USEPA, April 1992.

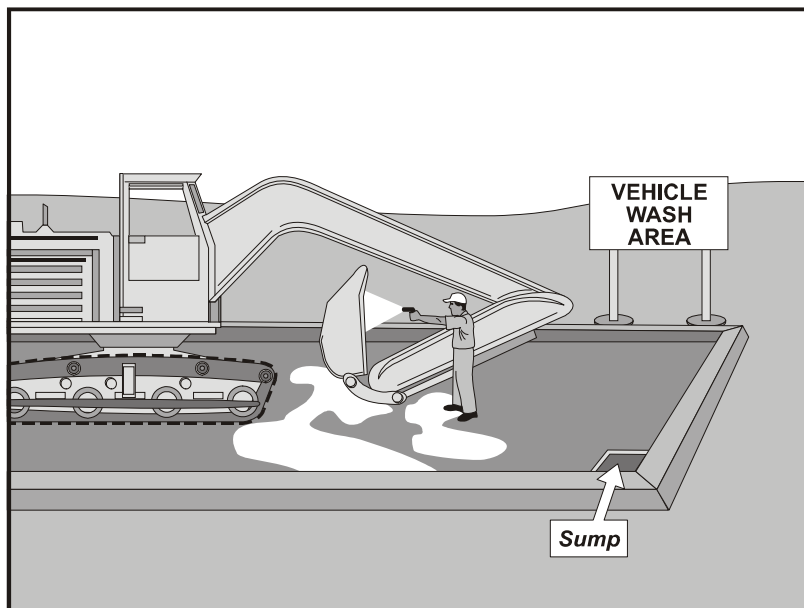

Description and Purpose

Vehicle and equipment cleaning procedures and practices eliminate or reduce the discharge of pollutants to stormwater from vehicle and equipment cleaning operations. Procedures and practices include but are not limited to: using offsite facilities; washing in designated, contained areas only; eliminating discharges to the storm drain by infiltrating the wash water; and training employees and subcontractors in proper cleaning procedures.

Suitable Applications

These procedures are suitable on all construction sites where vehicle and equipment cleaning is performed.

Limitations

Even phosphate-free, biodegradable soaps have been shown to be toxic to fish before the soap degrades. Sending vehicles/equipment offsite should be done in conjunction with TC-1, Stabilized Construction Entrance/Exit.

Implementation

Other options to washing equipment onsite include contracting with either an offsite or mobile commercial washing business. These businesses may be better equipped to handle and dispose of the wash waters properly. Performing this work offsite can also be economical by eliminating the need for a separate washing operation onsite.

If washing operations are to take place onsite, then:

Categories

EC	Erosion Control	
SE	Sediment Control	
TC	Tracking Control	
WE	Wind Erosion Control	
NS	Non-Stormwater Management Control	<input checked="" type="checkbox"/>
WM	Waste Management and Materials Pollution Control	

Legend:

- Primary Objective
- Secondary Objective

Targeted Constituents

Sediment	<input checked="" type="checkbox"/>
Nutrients	<input checked="" type="checkbox"/>
Trash	
Metals	
Bacteria	
Oil and Grease	<input checked="" type="checkbox"/>
Organics	<input checked="" type="checkbox"/>

Potential Alternatives

None



- Use phosphate-free, biodegradable soaps.
- Educate employees and subcontractors on pollution prevention measures.
- Do not permit steam cleaning onsite. Steam cleaning can generate significant pollutant concentrates.
- Cleaning of vehicles and equipment with soap, solvents or steam should not occur on the project site unless resulting wastes are fully contained and disposed of. Resulting wastes should not be discharged or buried, and must be captured and recycled or disposed according to the requirements of WM-10, Liquid Waste Management or WM-6, Hazardous Waste Management, depending on the waste characteristics. Minimize use of solvents. Use of diesel for vehicle and equipment cleaning is prohibited.
- All vehicles and equipment that regularly enter and leave the construction site must be cleaned offsite.
- When vehicle and equipment washing and cleaning must occur onsite, and the operation cannot be located within a structure or building equipped with appropriate disposal facilities, the outside cleaning area should have the following characteristics:
 - Located away from storm drain inlets, drainage facilities, or watercourses
 - Paved with concrete or asphalt and bermed to contain wash waters and to prevent runoff
 - Configured with a sump to allow collection and disposal of wash water
 - No discharge of wash waters to storm drains or watercourses
 - Used only when necessary
- When cleaning vehicles and equipment with water:
 - Use as little water as possible. High-pressure sprayers may use less water than a hose and should be considered
 - Use positive shutoff valve to minimize water usage
 - Facility wash racks should discharge to a sanitary sewer, recycle system or other approved discharge system and must not discharge to the storm drainage system, watercourses, or to groundwater

Costs

Cleaning vehicles and equipment at an offsite facility may reduce overall costs for vehicle and equipment cleaning by eliminating the need to provide similar services onsite. When onsite cleaning is needed, the cost to establish appropriate facilities is relatively low on larger, long-duration projects, and moderate to high on small, short-duration projects.

Inspection and Maintenance

- Inspect and verify that activity-based BMPs are in place prior to the commencement of associated activities. While activities associated with the BMP are under way, inspect weekly during the rainy season and at two-week intervals in the non-rainy season to verify continued BMP implementation.
- Inspect BMPs subject to non-stormwater discharges daily while non-stormwater discharges occur.
- Inspection and maintenance is minimal, although some berm repair may be necessary.
- Monitor employees and subcontractors throughout the duration of the construction project to ensure appropriate practices are being implemented.
- Inspect sump regularly and remove liquids and sediment as needed.
- Prohibit employees and subcontractors from washing personal vehicles and equipment on the construction site.

References

Stormwater Quality Handbooks - Construction Site Best Management Practices (BMPs) Manual, State of California Department of Transportation (Caltrans), November 2000.

Swisher, R.D. Surfactant Biodegradation, Marcel Decker Corporation, 1987.

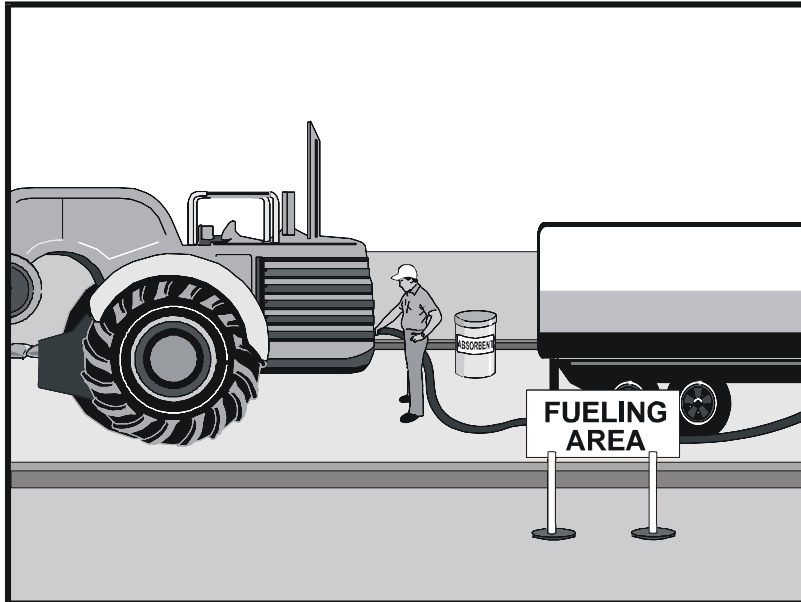

Description and Purpose

Vehicle equipment fueling procedures and practices are designed to prevent fuel spills and leaks, and reduce or eliminate contamination of stormwater. This can be accomplished by using offsite facilities, fueling in designated areas only, enclosing or covering stored fuel, implementing spill controls, and training employees and subcontractors in proper fueling procedures.

Suitable Applications

These procedures are suitable on all construction sites where vehicle and equipment fueling takes place.

Limitations

Onsite vehicle and equipment fueling should only be used where it is impractical to send vehicles and equipment offsite for fueling. Sending vehicles and equipment offsite should be done in conjunction with TC-1, Stabilized Construction Entrance/ Exit.

Implementation

- Use offsite fueling stations as much as possible. These businesses are better equipped to handle fuel and spills properly. Performing this work offsite can also be economical by eliminating the need for a separate fueling area at a site.
- Discourage “topping-off” of fuel tanks.
- Absorbent spill cleanup materials and spill kits should be available in fueling areas and on fueling trucks, and should

Categories

EC	Erosion Control	
SE	Sediment Control	
TC	Tracking Control	
WE	Wind Erosion Control	
NS	Non-Stormwater Management Control	<input checked="" type="checkbox"/>
WM	Waste Management and Materials Pollution Control	

Legend:

- Primary Objective
- Secondary Objective

Targeted Constituents

Sediment	
Nutrients	
Trash	
Metals	
Bacteria	
Oil and Grease	<input checked="" type="checkbox"/>
Organics	

Potential Alternatives

None



be disposed of properly after use.

- Drip pans or absorbent pads should be used during vehicle and equipment fueling, unless the fueling is performed over an impermeable surface in a dedicated fueling area.
- Use absorbent materials on small spills. Do not hose down or bury the spill. Remove the adsorbent materials promptly and dispose of properly.
- Avoid mobile fueling of mobile construction equipment around the site; rather, transport the equipment to designated fueling areas. With the exception of tracked equipment such as bulldozers and large excavators, most vehicles should be able to travel to a designated area with little lost time.
- Train employees and subcontractors in proper fueling and cleanup procedures.
- When fueling must take place onsite, designate an area away from drainage courses to be used. Fueling areas should be identified in the SWPPP.
- Dedicated fueling areas should be protected from stormwater runoff and should be located at least 50 ft away from downstream drainage facilities and watercourses. Fueling must be performed on level-grade areas.
- Protect fueling areas with berms and dikes to prevent runoff, and to contain spills.
- Nozzles used in vehicle and equipment fueling should be equipped with an automatic shutoff to control drips. Fueling operations should not be left unattended.
- Use vapor recovery nozzles to help control drips as well as air pollution where required by Air Quality Management Districts (AQMD).
- Federal, state, and local requirements should be observed for any stationary above ground storage tanks.

Costs

- All of the above measures are low cost except for the capital costs of above ground tanks that meet all local environmental, zoning, and fire codes.

Inspection and Maintenance

- Vehicles and equipment should be inspected each day of use for leaks. Leaks should be repaired immediately or problem vehicles or equipment should be removed from the project site.
- Keep ample supplies of spill cleanup materials onsite.
- Immediately clean up spills and properly dispose of contaminated soil and cleanup materials.

References

Blueprint for a Clean Bay: Best Management Practices to Prevent Stormwater Pollution from Construction Related Activities; Santa Clara Valley Nonpoint Source Pollution Control Program, 1995.

Coastal Nonpoint Pollution Control Program: Program Development and Approval Guidance, Working Group Working Paper; USEPA, April 1992.

Stormwater Quality Handbooks - Construction Site Best Management Practices (BMPs) Manual, State of California Department of Transportation (Caltrans), November 2000.

Stormwater Management for Construction Activities, Developing Pollution Prevention Plans and Best Management Practices, EPA 832-R-92005; USEPA, April 1992.

Vehicle & Equipment Maintenance NS-10

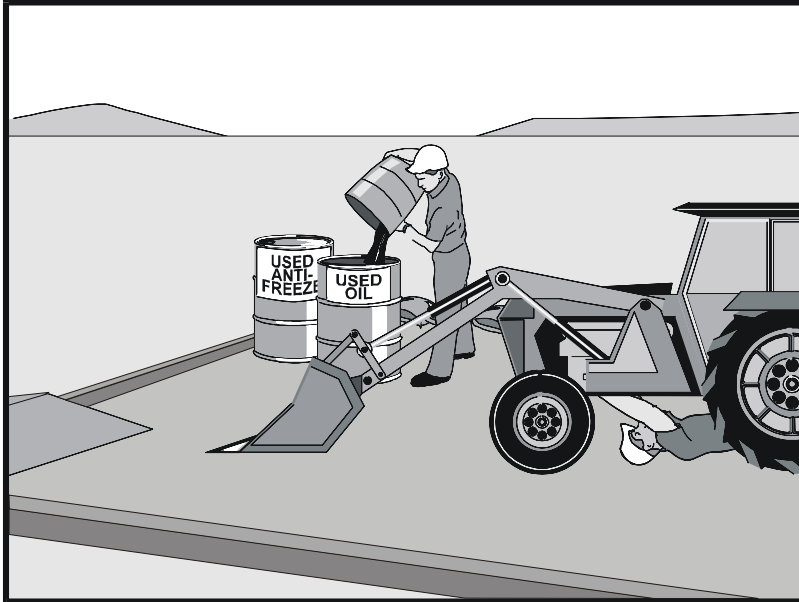

Description and Purpose

Prevent or reduce the contamination of stormwater resulting from vehicle and equipment maintenance by running a “dry and clean site”. The best option would be to perform maintenance activities at an offsite facility. If this option is not available then work should be performed in designated areas only, while providing cover for materials stored outside, checking for leaks and spills, and containing and cleaning up spills immediately. Employees and subcontractors must be trained in proper procedures.

Suitable Applications

These procedures are suitable on all construction projects where an onsite yard area is necessary for storage and maintenance of heavy equipment and vehicles.

Limitations

Onsite vehicle and equipment maintenance should only be used where it is impractical to send vehicles and equipment offsite for maintenance and repair. Sending vehicles/equipment offsite should be done in conjunction with TC-1, Stabilized Construction Entrance/Exit.

Outdoor vehicle or equipment maintenance is a potentially significant source of stormwater pollution. Activities that can contaminate stormwater include engine repair and service, changing or replacement of fluids, and outdoor equipment storage and parking (engine fluid leaks). For further information on vehicle or equipment servicing, see NS-8, Vehicle and Equipment Cleaning, and NS-9, Vehicle and

Categories

EC	Erosion Control	
SE	Sediment Control	
TC	Tracking Control	
WE	Wind Erosion Control	
NS	Non-Stormwater Management Control	<input checked="" type="checkbox"/>
WM	Waste Management and Materials Pollution Control	

Legend:

- Primary Objective
- Secondary Objective

Targeted Constituents

Sediment	
Nutrients	<input checked="" type="checkbox"/>
Trash	<input checked="" type="checkbox"/>
Metals	
Bacteria	
Oil and Grease	<input checked="" type="checkbox"/>
Organics	<input checked="" type="checkbox"/>

Potential Alternatives

None



Vehicle & Equipment Maintenance NS-10

Equipment Fueling.

Implementation

- Use offsite repair shops as much as possible. These businesses are better equipped to handle vehicle fluids and spills properly. Performing this work offsite can also be economical by eliminating the need for a separate maintenance area.
- If maintenance must occur onsite, use designated areas, located away from drainage courses. Dedicated maintenance areas should be protected from stormwater runoff and should be located at least 50 ft from downstream drainage facilities and watercourses.
- Drip pans or absorbent pads should be used during vehicle and equipment maintenance work that involves fluids, unless the maintenance work is performed over an impermeable surface in a dedicated maintenance area.
- Place a stockpile of spill cleanup materials where it will be readily accessible.
- All fueling trucks and fueling areas are required to have spill kits and/or use other spill protection devices.
- Use adsorbent materials on small spills. Remove the absorbent materials promptly and dispose of properly.
- Inspect onsite vehicles and equipment daily at startup for leaks, and repair immediately.
- Keep vehicles and equipment clean; do not allow excessive build-up of oil and grease.
- Segregate and recycle wastes, such as greases, used oil or oil filters, antifreeze, cleaning solutions, automotive batteries, hydraulic and transmission fluids. Provide secondary containment and covers for these materials if stored onsite.
- Train employees and subcontractors in proper maintenance and spill cleanup procedures.
- Drip pans or plastic sheeting should be placed under all vehicles and equipment placed on docks, barges, or other structures over water bodies when the vehicle or equipment is planned to be idle for more than 1 hour.
- For long-term projects, consider using portable tents or covers over maintenance areas if maintenance cannot be performed offsite.
- Consider use of new, alternative greases and lubricants, such as adhesive greases, for chassis lubrication and fifth-wheel lubrication.
- Properly dispose of used oils, fluids, lubricants, and spill cleanup materials.
- Do not place used oil in a dumpster or pour into a storm drain or watercourse.
- Properly dispose of or recycle used batteries.
- Do not bury used tires.

Vehicle & Equipment Maintenance NS-10

- Repair leaks of fluids and oil immediately.

Listed below is further information if you must perform vehicle or equipment maintenance onsite.

Safer Alternative Products

- Consider products that are less toxic or hazardous than regular products. These products are often sold under an “environmentally friendly” label.
- Consider use of grease substitutes for lubrication of truck fifth-wheels. Follow manufacturers label for details on specific uses.
- Consider use of plastic friction plates on truck fifth-wheels in lieu of grease. Follow manufacturers label for details on specific uses.

Waste Reduction

Parts are often cleaned using solvents such as trichloroethylene, trichloroethane, or methylene chloride. Many of these cleaners are listed in California Toxic Rule as priority pollutants. These materials are harmful and must not contaminate stormwater. They must be disposed of as a hazardous waste. Reducing the number of solvents makes recycling easier and reduces hazardous waste management costs. Often, one solvent can perform a job as well as two different solvents. Also, if possible, eliminate or reduce the amount of hazardous materials and waste by substituting non-hazardous or less hazardous materials. For example, replace chlorinated organic solvents with non-chlorinated solvents. Non-chlorinated solvents like kerosene or mineral spirits are less toxic and less expensive to dispose of properly. Check the list of active ingredients to see whether it contains chlorinated solvents. The “chlor” term indicates that the solvent is chlorinated. Also, try substituting a wire brush for solvents to clean parts.

Recycling and Disposal

Separating wastes allows for easier recycling and may reduce disposal costs. Keep hazardous wastes separate, do not mix used oil solvents, and keep chlorinated solvents (like, -trichloroethane) separate from non-chlorinated solvents (like kerosene and mineral spirits). Promptly transfer used fluids to the proper waste or recycling drums. Don't leave full drip pans or other open containers lying around. Provide cover and secondary containment until these materials can be removed from the site.

Oil filters can be recycled. Ask your oil supplier or recycler about recycling oil filters.

Do not dispose of extra paints and coatings by dumping liquid onto the ground or throwing it into dumpsters. Allow coatings to dry or harden before disposal into covered dumpsters.

Store cracked batteries in a non-leaking secondary container. Do this with all cracked batteries, even if you think all the acid has drained out. If you drop a battery, treat it as if it is cracked. Put it into the containment area until you are sure it is not leaking.

Costs

All of the above are low cost measures. Higher costs are incurred to setup and maintain onsite maintenance areas.

Vehicle & Equipment Maintenance NS-10

Inspection and Maintenance

- Inspect and verify that activity-based BMPs are in place prior to the commencement of associated activities. While activities associated with the BMP are under way, inspect weekly during the rainy season and at two-week intervals in the non-rainy season to verify continued BMP implementation.
- Inspect BMPs subject to non-stormwater discharges daily while non-stormwater discharges occur.
- Keep ample supplies of spill cleanup materials onsite.
- Maintain waste fluid containers in leak proof condition.
- Vehicles and equipment should be inspected on each day of use. Leaks should be repaired immediately or the problem vehicle(s) or equipment should be removed from the project site.
- Inspect equipment for damaged hoses and leaky gaskets routinely. Repair or replace as needed.

References

Blueprint for a Clean Bay: Best Management Practices to Prevent Stormwater Pollution from Construction Related Activities; Santa Clara Valley Nonpoint Source Pollution Control Program, 1995.

Coastal Nonpoint Pollution Control Program; Program Development and Approval Guidance, Working Group, Working Paper; USEPA, April 1992.

Stormwater Quality Handbooks - Construction Site Best Management Practices (BMPs) Manual, State of California Department of Transportation (Caltrans), November 2000.

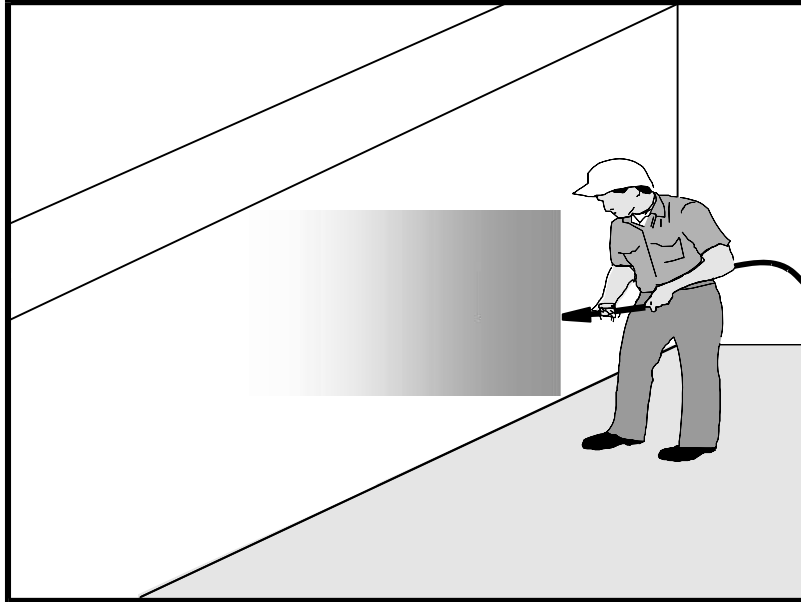

Description and Purpose

Concrete curing is used in the construction of structures such as bridges, retaining walls, pump houses, large slabs, and structured foundations. Concrete curing includes the use of both chemical and water methods.

Concrete and its associated curing materials have basic chemical properties that can raise the pH of water to levels outside of the permitted range. Discharges of stormwater and non-stormwater exposed to concrete during curing may have a high pH and may contain chemicals, metals, and fines. The General Permit incorporates Numeric Effluent Limits (NEL) and Numeric Action Levels (NAL) for pH (see Section 2 of this handbook to determine your project's risk level and if you are subject to these requirements).

Proper procedures and care should be taken when managing concrete curing materials to prevent them from coming into contact with stormwater flows, which could result in a high pH discharge.

Suitable Applications

Suitable applications include all projects where Portland Cement Concrete (PCC) and concrete curing chemicals are placed where they can be exposed to rainfall, runoff from other areas, or where runoff from the PCC will leave the site.

Categories

EC	Erosion Control	
SE	Sediment Control	
TC	Tracking Control	
WE	Wind Erosion Control	
NS	Non-Stormwater Management Control	<input checked="" type="checkbox"/>
WM	Waste Management and Materials Pollution Control	<input checked="" type="checkbox"/>

Legend:

- Primary Category
- Secondary Category

Targeted Constituents

Sediment	<input checked="" type="checkbox"/>
Nutrients	
Trash	
Metals	<input checked="" type="checkbox"/>
Bacteria	
Oil and Grease	<input checked="" type="checkbox"/>
Organics	

Potential Alternatives

None



Limitations

- Runoff contact with concrete waste can raise pH levels in the water to environmentally harmful levels and trigger permit violations.

Implementation

Chemical Curing

- Avoid over spray of curing compounds.
- Minimize the drift by applying the curing compound close to the concrete surface. Apply an amount of compound that covers the surface, but does not allow any runoff of the compound.
- Use proper storage and handling techniques for concrete curing compounds. Refer to WM-1, Material Delivery and Storage.
- Protect drain inlets prior to the application of curing compounds.
- Refer to WM-4, Spill Prevention and Control.

Water Curing for Bridge Decks, Retaining Walls, and other Structures

- Direct cure water away from inlets and watercourses to collection areas for evaporation or other means of removal in accordance with all applicable permits. See WM-8 Concrete Waste Management.
- Collect cure water at the top of slopes and transport to a concrete waste management area in a non-erosive manner. See EC-9 Earth Dikes and Drainage Swales, EC-10, Velocity Dissipation Devices, and EC-11, Slope Drains.
- Utilize wet blankets or a similar method that maintains moisture while minimizing the use and possible discharge of water.

Education

- Educate employees, subcontractors, and suppliers on proper concrete curing techniques to prevent contact with discharge as described herein.
- Arrange for the QSP or the appropriately trained contractor's superintendent or representative to oversee and enforce concrete curing procedures.

Costs

All of the above measures are generally low cost.

Inspection and Maintenance

- Inspect and verify that activity-based BMPs are in place prior to the commencement of associated activities.
- BMPs must be inspected in accordance with General Permit requirements for the associated project type and risk level. It is recommended that at a minimum, BMPs be inspected weekly, prior to forecasted rain events, daily during extended rain events, and after the conclusion of rain events.

- Inspect BMPs subject to non-stormwater discharges daily while non-stormwater discharges occur.
- Sample non-stormwater discharges and stormwater runoff that contacts uncured and partially cured concrete as required by the General Permit.
- Ensure that employees and subcontractors implement appropriate measures for storage, handling, and use of curing compounds.
- Inspect cure containers and spraying equipment for leaks.

References

Blue Print for a Clean Bay-Construction-Related Industries: Best Management Practices for Stormwater Pollution Prevention; Santa Clara Valley Non Point Source Pollution Control Program, 1992.

Stormwater Quality Handbooks - Construction Site Best Management Practices (BMPs) Manual, State of California Department of Transportation (Caltrans), March 2003.

Stormwater Management for Construction Activities, Developing Pollution Prevention Plans and Best Management Practices, EPA 832-R-92005; USEPA, April 1992.

Erosion and Sediment Control Manual, Oregon Department of Environmental Quality, February 2005.

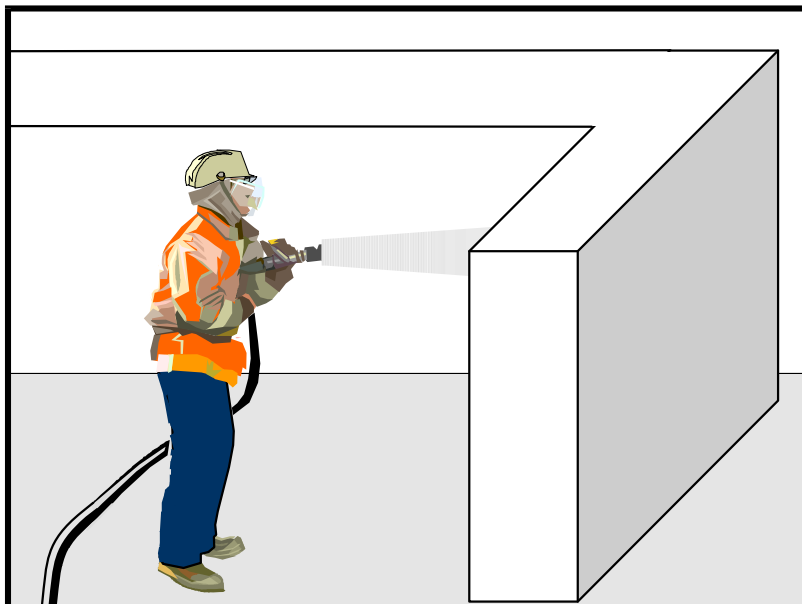

Description and Purpose

Concrete finishing methods are used for bridge deck rehabilitation, paint removal, curing compound removal, and final surface finish appearances. Methods include sand blasting, shot blasting, grinding, or high pressure water blasting. Stormwater and non-stormwater exposed to concrete finishing by-products may have a high pH and may contain chemicals, metals, and fines. Proper procedures and implementation of appropriate BMPs can minimize the impact that concrete-finishing methods may have on stormwater and non-stormwater discharges.

The General Permit incorporates Numeric Effluent Limits (NEL) and Numeric Action Levels (NAL) for pH (see Section 2 of this handbook to determine your project’s risk level and if you are subject to these requirements).

Concrete and its associated curing materials have basic chemical properties that can raise pH levels outside of the permitted range. Additional care should be taken when managing these materials to prevent them from coming into contact with stormwater flows, which could lead to exceedances of the General Permit requirements.

Suitable Applications

These procedures apply to all construction locations where concrete finishing operations are performed.

Categories

EC	Erosion Control	
SE	Sediment Control	
TC	Tracking Control	
WE	Wind Erosion Control	
NS	Non-Stormwater Management Control	<input checked="" type="checkbox"/>
WM	Waste Management and Materials Pollution Control	<input checked="" type="checkbox"/>

Legend:

- Primary Category
- Secondary Category

Targeted Constituents

Sediment	<input checked="" type="checkbox"/>
Nutrients	
Trash	
Metals	<input checked="" type="checkbox"/>
Bacteria	
Oil and Grease	
Organics	<input checked="" type="checkbox"/>

Potential Alternatives

None



Limitations

- Runoff contact with concrete waste can raise pH levels in the water to environmentally harmful levels and trigger permit violations.

Implementation

- Collect and properly dispose of water from high-pressure water blasting operations.
- Collect contaminated water from blasting operations at the top of slopes. Transport or dispose of contaminated water while using BMPs such as those for erosion control. Refer to EC-9, Earth Dikes and Drainage Swales, EC-10, Velocity Dissipation Devices, and EC-11, Slope Drains.
- Direct water from blasting operations away from inlets and watercourses to collection areas for infiltration or other means of removal (dewatering). Refer to NS-2 Dewatering Operations.
- Protect inlets during sandblasting operations. Refer to SE-10, Storm Drain Inlet Protection.
- Refer to WM-8, Concrete Waste Management for disposal of concrete debris.
- Minimize the drift of dust and blast material as much as possible by keeping the blasting nozzle close to the surface.
- When blast residue contains a potentially hazardous waste, refer to WM-6, Hazardous Waste Management.

Education

- Educate employees, subcontractors, and suppliers on proper concrete finishing techniques to prevent contact with discharge as described herein.
- Arrange for the QSP or the appropriately trained contractor's superintendent or representative to oversee and enforce concrete finishing procedures.

Costs

These measures are generally of low cost.

Inspection and Maintenance

- Inspect and verify that activity-based BMPs are in place prior to the commencement of associated activities.
- BMPs must be inspected in accordance with General Permit requirements for the associated project type and risk level. It is recommended that at a minimum, BMPs be inspected weekly, prior to forecasted rain events, daily during extended rain events, and after the conclusion of rain events.
- Inspect BMPs subject to non-stormwater discharges daily while non-stormwater discharges occur.
- Sample non-stormwater discharges and stormwater runoff that contacts concrete dust and debris as required by the General Permit.

- Sweep or vacuum up debris from sandblasting at the end of each shift.
- At the end of each work shift, remove and contain liquid and solid waste from containment structures, if any, and from the general work area.
- Inspect containment structures for damage prior to use and prior to onset of forecasted rain.

References

Blueprint for a Clean Bay: Best Management Practices to Prevent Stormwater Pollution from Construction Related Activities; Santa Clara Valley Nonpoint Source Pollution Control Program, 1995.

Stormwater Quality Handbooks - Construction Site Best Management Practices (BMPs) Manual, State of California Department of Transportation (Caltrans), March 2003.

Stormwater Management for Construction Activities, Developing Pollution Prevention Plans and Best Management Practices, EPA 832-R-92005; USEPA, April 1992.

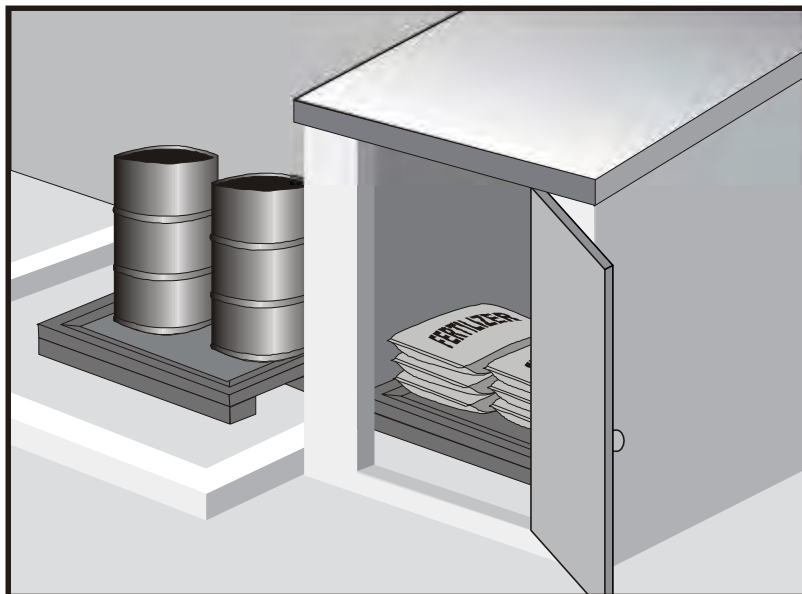

Categories

EC	Erosion Control	
SE	Sediment Control	
TC	Tracking Control	
WE	Wind Erosion Control	
NS	Non-Stormwater Management Control	
WM	Waste Management and Materials Pollution Control	<input checked="" type="checkbox"/>

Legend:

- Primary Category
- Secondary Category

Description and Purpose

Prevent, reduce, or eliminate the discharge of pollutants from material delivery and storage to the stormwater system or watercourses by minimizing the storage of hazardous materials onsite, storing materials in watertight containers and/or a completely enclosed designated area, installing secondary containment, conducting regular inspections, and training employees and subcontractors.

This best management practice covers only material delivery and storage. For other information on materials, see WM-2, Material Use, or WM-4, Spill Prevention and Control. For information on wastes, see the waste management BMPs in this section.

Suitable Applications

These procedures are suitable for use at all construction sites with delivery and storage of the following materials:

- Soil stabilizers and binders
- Pesticides and herbicides
- Fertilizers
- Detergents
- Plaster
- Petroleum products such as fuel, oil, and grease

Targeted Constituents

Sediment	<input checked="" type="checkbox"/>
Nutrients	<input checked="" type="checkbox"/>
Trash	<input checked="" type="checkbox"/>
Metals	<input checked="" type="checkbox"/>
Bacteria	
Oil and Grease	<input checked="" type="checkbox"/>
Organics	<input checked="" type="checkbox"/>

Potential Alternatives

None



- Asphalt and concrete components
- Hazardous chemicals such as acids, lime, glues, adhesives, paints, solvents, and curing compounds
- Concrete compounds
- Other materials that may be detrimental if released to the environment

Limitations

- Space limitation may preclude indoor storage.
- Storage sheds often must meet building and fire code requirements.

Implementation

The following steps should be taken to minimize risk:

- Chemicals must be stored in water tight containers with appropriate secondary containment or in a storage shed.
- When a material storage area is located on bare soil, the area should be lined and bermed.
- Use containment pallets or other practical and available solutions, such as storing materials within newly constructed buildings or garages, to meet material storage requirements.
- Stack erodible landscape material on pallets and cover when not in use.
- Contain all fertilizers and other landscape materials when not in use.
- Temporary storage areas should be located away from vehicular traffic.
- Material Safety Data Sheets (MSDS) should be available on-site for all materials stored that have the potential to effect water quality.
- Construction site areas should be designated for material delivery and storage.
- Material delivery and storage areas should be located away from waterways, if possible.
 - Avoid transport near drainage paths or waterways.
 - Surround with earth berms or other appropriate containment BMP. See EC-9, Earth Dikes and Drainage Swales.
 - Place in an area that will be paved.
- Storage of reactive, ignitable, or flammable liquids must comply with the fire codes of your area. Contact the local Fire Marshal to review site materials, quantities, and proposed storage area to determine specific requirements. See the Flammable and Combustible Liquid Code, NFPA30.
- An up to date inventory of materials delivered and stored onsite should be kept.

- Hazardous materials storage onsite should be minimized.
- Hazardous materials should be handled as infrequently as possible.
- Keep ample spill cleanup supplies appropriate for the materials being stored. Ensure that cleanup supplies are in a conspicuous, labeled area.
- Employees and subcontractors should be trained on the proper material delivery and storage practices.
- Employees trained in emergency spill cleanup procedures must be present when dangerous materials or liquid chemicals are unloaded.
- If significant residual materials remain on the ground after construction is complete, properly remove and dispose of materials and any contaminated soil. See WM-7, Contaminated Soil Management. If the area is to be paved, pave as soon as materials are removed to stabilize the soil.

Material Storage Areas and Practices

- Liquids, petroleum products, and substances listed in 40 CFR Parts 110, 117, or 302 should be stored in approved containers and drums and should not be overfilled. Containers and drums should be placed in temporary containment facilities for storage.
- A temporary containment facility should provide for a spill containment volume able to contain precipitation from a 25 year storm event, plus the greater of 10% of the aggregate volume of all containers or 100% of the capacity of the largest container within its boundary, whichever is greater.
- A temporary containment facility should be impervious to the materials stored therein for a minimum contact time of 72 hours.
- A temporary containment facility should be maintained free of accumulated rainwater and spills. In the event of spills or leaks, accumulated rainwater and spills should be collected and placed into drums. These liquids should be handled as a hazardous waste unless testing determines them to be non-hazardous. All collected liquids or non-hazardous liquids should be sent to an approved disposal site.
- Sufficient separation should be provided between stored containers to allow for spill cleanup and emergency response access.
- Incompatible materials, such as chlorine and ammonia, should not be stored in the same temporary containment facility.
- Materials should be covered prior to, and during rain events.
- Materials should be stored in their original containers and the original product labels should be maintained in place in a legible condition. Damaged or otherwise illegible labels should be replaced immediately.

- Bagged and boxed materials should be stored on pallets and should not be allowed to accumulate on the ground. To provide protection from wind and rain throughout the rainy season, bagged and boxed materials should be covered during non-working days and prior to and during rain events.
- Stockpiles should be protected in accordance with WM-3, Stockpile Management.
- Materials should be stored indoors within existing structures or completely enclosed storage sheds when available.
- Proper storage instructions should be posted at all times in an open and conspicuous location.
- An ample supply of appropriate spill clean up material should be kept near storage areas.
- Also see WM-6, Hazardous Waste Management, for storing of hazardous wastes.

Material Delivery Practices

- Keep an accurate, up-to-date inventory of material delivered and stored onsite.
- Arrange for employees trained in emergency spill cleanup procedures to be present when dangerous materials or liquid chemicals are unloaded.

Spill Cleanup

- Contain and clean up any spill immediately.
- Properly remove and dispose of any hazardous materials or contaminated soil if significant residual materials remain on the ground after construction is complete. See WM-7, Contaminated Soil Management.
- See WM-4, Spill Prevention and Control, for spills of chemicals and/or hazardous materials.
- If spills or leaks of materials occur that are not contained and could discharge to surface waters, non-visible sampling of site discharge may be required. Refer to the General Permit or to your project specific Construction Site Monitoring Plan to determine if and where sampling is required.

Cost

- The largest cost of implementation may be in the construction of a materials storage area that is covered and provides secondary containment.

Inspection and Maintenance

- BMPs must be inspected in accordance with General Permit requirements for the associated project type and risk level. It is recommended that at a minimum, BMPs be inspected weekly, prior to forecasted rain events, daily during extended rain events, and after the conclusion of rain events.
- Keep storage areas clean and well organized, including a current list of all materials onsite.
- Inspect labels on containers for legibility and accuracy.

- Repair or replace perimeter controls, containment structures, covers, and liners as needed to maintain proper function.

References

Blueprint for a Clean Bay: Best Management Practices to Prevent Stormwater Pollution from Construction Related Activities; Santa Clara Valley Nonpoint Source Pollution Control Program, 1995.

Coastal Nonpoint Pollution Control Program: Program Development and Approval Guidance, Working Group Working Paper; USEPA, April 1992.

Stormwater Quality Handbooks - Construction Site Best Management Practices (BMPs) Manual, State of California Department of Transportation (Caltrans), March 2003.

Stormwater Management for Construction Activities; Developing Pollution Prevention Plans and Best Management Practice, EPA 832-R-92005; USEPA, April 1992.

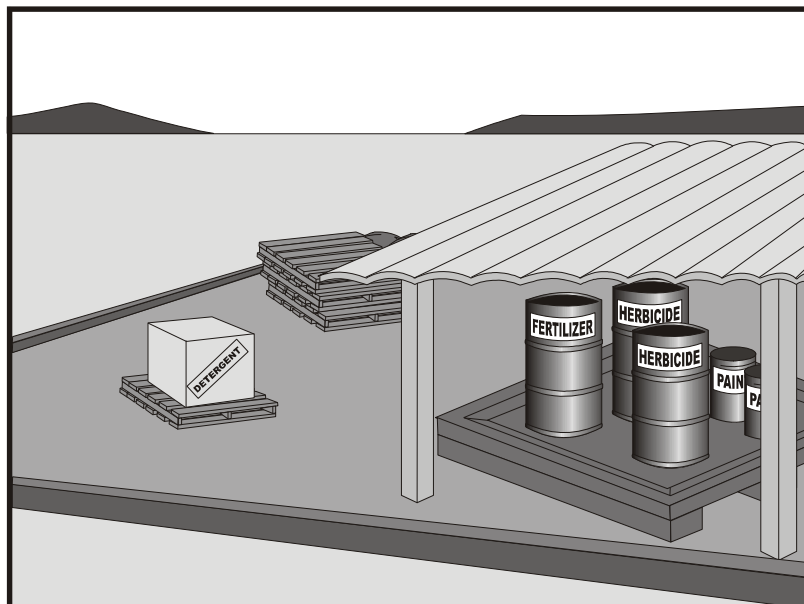

Description and Purpose

Prevent or reduce the discharge of pollutants to the storm drain system or watercourses from material use by using alternative products, minimizing hazardous material use onsite, and training employees and subcontractors.

Suitable Applications

This BMP is suitable for use at all construction projects. These procedures apply when the following materials are used or prepared onsite:

- Pesticides and herbicides
- Fertilizers
- Detergents
- Petroleum products such as fuel, oil, and grease
- Asphalt and other concrete components
- Other hazardous chemicals such as acids, lime, glues, adhesives, paints, solvents, and curing compounds
- Other materials that may be detrimental if released to the environment

Categories

EC	Erosion Control	
SE	Sediment Control	
TC	Tracking Control	
WE	Wind Erosion Control	
NS	Non-Stormwater Management Control	
WM	Waste Management and Materials Pollution Control	<input checked="" type="checkbox"/>

Legend:

- Primary Category
- Secondary Category

Targeted Constituents

Sediment	<input checked="" type="checkbox"/>
Nutrients	<input checked="" type="checkbox"/>
Trash	<input checked="" type="checkbox"/>
Metals	<input checked="" type="checkbox"/>
Bacteria	
Oil and Grease	<input checked="" type="checkbox"/>
Organics	<input checked="" type="checkbox"/>

Potential Alternatives

None



Limitations

Safer alternative building and construction products may not be available or suitable in every instance.

Implementation

The following steps should be taken to minimize risk:

- Minimize use of hazardous materials onsite.
- Follow manufacturer instructions regarding uses, protective equipment, ventilation, flammability, and mixing of chemicals.
- Train personnel who use pesticides. The California Department of Pesticide Regulation and county agricultural commissioners license pesticide dealers, certify pesticide applicators, and conduct onsite inspections.
- The preferred method of termiticide application is soil injection near the existing or proposed structure foundation/slab; however, if not feasible, soil drench application of termiticides should follow EPA label guidelines and the following recommendations (most of which are applicable to most pesticide applications):
 - Do not treat soil that is water-saturated or frozen.
 - Application shall not commence within 24-hours of a predicted precipitation event with a 40% or greater probability. Weather tracking must be performed on a daily basis prior to termiticide application and during the period of termiticide application.
 - Do not allow treatment chemicals to runoff from the target area. Apply proper quantity to prevent excess runoff. Provide containment for and divert stormwater from application areas using berms or diversion ditches during application.
 - Dry season: Do not apply within 10 feet of storm drains. Do not apply within 25 feet of aquatic habitats (such as, but not limited to, lakes; reservoirs; rivers; permanent streams; marshes or ponds; estuaries; and commercial fish farm ponds).
 - Wet season: Do not apply within 50 feet of storm drains or aquatic habitats (such as, but not limited to, lakes; reservoirs; rivers; permanent streams; marshes or ponds; estuaries; and commercial fish farm ponds) unless a vegetative buffer is present (if so, refer to dry season requirements).
 - Do not make on-grade applications when sustained wind speeds are above 10 mph (at application site) at nozzle end height.
 - Cover treatment site prior to a rain event in order to prevent run-off of the pesticide into non-target areas. The treated area should be limited to a size that can be backfilled and/or covered by the end of the work shift. Backfilling or covering of the treated area shall be done by the end of the same work shift in which the application is made.
 - The applicator must either cover the soil him/herself or provide written notification of the above requirement to the contractor on site and to the person commissioning the

application (if different than the contractor). If notice is provided to the contractor or the person commissioning the application, then they are responsible under the Federal Insecticide Fungicide, and Rodenticide Act (FIFRA) to ensure that: 1) if the concrete slab cannot be poured over the treated soil within 24 hours of application, the treated soil is covered with a waterproof covering (such as polyethylene sheeting), and 2) the treated soil is covered if precipitation is predicted to occur before the concrete slab is scheduled to be poured.

- Do not over-apply fertilizers, herbicides, and pesticides. Prepare only the amount needed. Follow the recommended usage instructions. Over-application is expensive and environmentally harmful. Unless on steep slopes, till fertilizers into the soil rather than hydraulic application. Apply surface dressings in several smaller applications, as opposed to one large application, to allow time for infiltration and to avoid excess material being carried offsite by runoff. Do not apply these chemicals before predicted rainfall.
- Train employees and subcontractors in proper material use.
- Supply Material Safety Data Sheets (MSDS) for all materials.
- Dispose of latex paint and paint cans, used brushes, rags, absorbent materials, and drop cloths, when thoroughly dry and are no longer hazardous, with other construction debris.
- Do not remove the original product label; it contains important safety and disposal information. Use the entire product before disposing of the container.
- Mix paint indoors or in a containment area. Never clean paintbrushes or rinse paint containers into a street, gutter, storm drain, or watercourse. Dispose of any paint thinners, residue, and sludge(s) that cannot be recycled, as hazardous waste.
- For water-based paint, clean brushes to the extent practicable, and rinse to a drain leading to a sanitary sewer where permitted, or contain for proper disposal off site. For oil-based paints, clean brushes to the extent practicable, and filter and reuse thinners and solvents.
- Use recycled and less hazardous products when practical. Recycle residual paints, solvents, non-treated lumber, and other materials.
- Use materials only where and when needed to complete the construction activity. Use safer alternative materials as much as possible. Reduce or eliminate use of hazardous materials onsite when practical.
- Document the location, time, chemicals applied, and applicator's name and qualifications.
- Keep an ample supply of spill clean up material near use areas. Train employees in spill clean up procedures.
- Avoid exposing applied materials to rainfall and runoff unless sufficient time has been allowed for them to dry.
- Discontinue use of erodible landscape material within 2 days prior to a forecasted rain event and materials should be covered and/or bermed.

- Provide containment for material use areas such as masons' areas or paint mixing/preparation areas to prevent materials/pollutants from entering stormwater.

Costs

All of the above are low cost measures.

Inspection and Maintenance

- Inspect and verify that activity-based BMPs are in place prior to the commencement of associated activities.
- BMPs must be inspected in accordance with General Permit requirements for the associated project type and risk level. It is recommended that at a minimum, BMPs be inspected weekly, prior to forecasted rain events, daily during extended rain events, and after the conclusion of rain events.
- Ensure employees and subcontractors throughout the job are using appropriate practices.

References

Blueprint for a Clean Bay: Best Management Practices to Prevent Stormwater Pollution from Construction Related Activities; Santa Clara Valley Nonpoint Source Pollution Control Program, 1995.

Coastal Nonpoint Pollution Control Program: Program Development and Approval Guidance, Working Group Working Paper; USEPA, April 1992.

Comments on Risk Assessments Risk Reduction Options for Cypermethrin: Docket No. OPP-2005-0293; California Stormwater Quality Association (CASQA) letter to USEPA, 2006. Environmental Hazard and General Labeling for Pyrethroid Non-Agricultural Outdoor Products, EPA-HQ-OPP-2008-0331-0021; USEPA, 2008.

Stormwater Quality Handbooks - Construction Site Best Management Practices (BMPs) Manual, State of California Department of Transportation (Caltrans), March 2003.

Stormwater Management for Construction Activities; Developing Pollution Prevention Plans and Best Management Practice, EPA 832-R-92005; USEPA, April 1992.

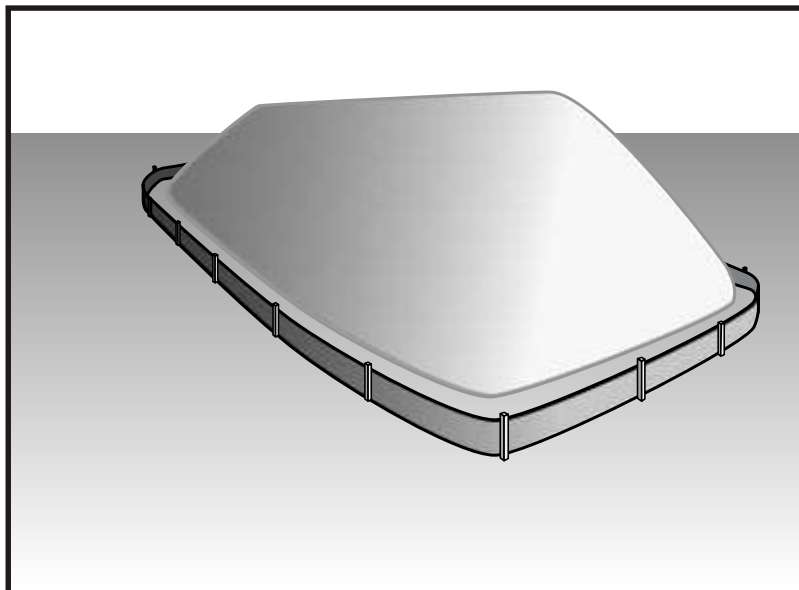

Description and Purpose

Stockpile management procedures and practices are designed to reduce or eliminate air and stormwater pollution from stockpiles of soil, soil amendments, sand, paving materials such as portland cement concrete (PCC) rubble, asphalt concrete (AC), asphalt concrete rubble, aggregate base, aggregate sub base or pre-mixed aggregate, asphalt minder (so called “cold mix” asphalt), and pressure treated wood.

Suitable Applications

Implement in all projects that stockpile soil and other loose materials.

Limitations

- Plastic sheeting as a stockpile protection is temporary and hard to manage in windy conditions. Where plastic is used, consider use of plastic tarps with nylon reinforcement which may be more durable than standard sheeting.
- Plastic sheeting can increase runoff volume due to lack of infiltration and potentially cause perimeter control failure.
- Plastic sheeting breaks down faster in sunlight.
- The use of Plastic materials and photodegradable plastics should be avoided.

Implementation

Protection of stockpiles is a year-round requirement. To properly manage stockpiles:

Categories

EC	Erosion Control	
SE	Sediment Control	<input checked="" type="checkbox"/>
TC	Tracking Control	
WE	Wind Erosion Control	
NS	Non-Stormwater Management Control	<input checked="" type="checkbox"/>
WM	Waste Management and Materials Pollution Control	<input checked="" type="checkbox"/>

Legend:

- Primary Category
- Secondary Category

Targeted Constituents

Sediment	<input checked="" type="checkbox"/>
Nutrients	<input checked="" type="checkbox"/>
Trash	<input checked="" type="checkbox"/>
Metals	<input checked="" type="checkbox"/>
Bacteria	
Oil and Grease	<input checked="" type="checkbox"/>
Organics	<input checked="" type="checkbox"/>

Potential Alternatives

None



- On larger sites, a minimum of 50 ft separation from concentrated flows of stormwater, drainage courses, and inlets is recommended.
- All stockpiles are required to be protected immediately if they are not scheduled to be used within 14 days.
- Protect all stockpiles from stormwater runoff using temporary perimeter sediment barriers such as compost berms (SE-13), temporary silt dikes (SE-12), fiber rolls (SE-5), silt fences (SE-1), sandbags (SE-8), gravel bags (SE-6), or biofilter bags (SE-14). Refer to the individual fact sheet for each of these controls for installation information.
- Implement wind erosion control practices as appropriate on all stockpiled material. For specific information, see WE-1, Wind Erosion Control.
- Manage stockpiles of contaminated soil in accordance with WM-7, Contaminated Soil Management.
- Place bagged materials on pallets and under cover.
- Ensure that stockpile coverings are installed securely to protect from wind and rain.
- Some plastic covers withstand weather and sunlight better than others. Select cover materials or methods based on anticipated duration of use.

Protection of Non-Active Stockpiles

Non-active stockpiles of the identified materials should be protected further as follows:

Soil stockpiles

- Soil stockpiles should be covered or protected with soil stabilization measures and a temporary perimeter sediment barrier at all times.
- Temporary vegetation should be considered for topsoil piles that will be stockpiled for extended periods.

Stockpiles of Portland cement concrete rubble, asphalt concrete, asphalt concrete rubble, aggregate base, or aggregate sub base

- Stockpiles should be covered and protected with a temporary perimeter sediment barrier at all times.

Stockpiles of “cold mix”

- Cold mix stockpiles should be placed on and covered with plastic sheeting or comparable material at all times and surrounded by a berm.

Stockpiles of fly ash, stucco, hydrated lime

- Stockpiles of materials that may raise the pH of runoff (i.e., basic materials) should be covered with plastic and surrounded by a berm.

Stockpiles/Storage of wood (Pressure treated with chromated copper arsenate or ammoniacal copper zinc arsenate)

- Treated wood should be covered with plastic sheeting or comparable material at all times and surrounded by a berm.

Protection of Active Stockpiles

Active stockpiles of the identified materials should be protected as follows:

- All stockpiles should be covered and protected with a temporary linear sediment barrier prior to the onset of precipitation.
- Stockpiles of “cold mix” and treated wood, and basic materials should be placed on and covered with plastic sheeting or comparable material and surrounded by a berm prior to the onset of precipitation.
- The downstream perimeter of an active stockpile should be protected with a linear sediment barrier or berm and runoff should be diverted around or away from the stockpile on the upstream perimeter.

Costs

For cost information associated with stockpile protection refer to the individual erosion or sediment control BMP fact sheet considered for implementation (For example, refer to SE-1 Silt Fence for installation of silt fence around the perimeter of a stockpile.)

Inspection and Maintenance

- Stockpiles must be inspected in accordance with General Permit requirements for the associated project type and risk level. It is recommended that at a minimum, BMPs be inspected weekly, prior to forecasted rain events, daily during extended rain events, and after the conclusion of rain events.
- It may be necessary to inspect stockpiles covered with plastic sheeting more frequently during certain conditions (for example, high winds or extreme heat).
- Repair and/or replace perimeter controls and covers as needed to keep them functioning properly.
- Sediment shall be removed when it reaches one-third of the barrier height.

References

Stormwater Quality Handbooks - Construction Site Best Management Practices (BMPs) Manual, State of California Department of Transportation (Caltrans), March 2003.

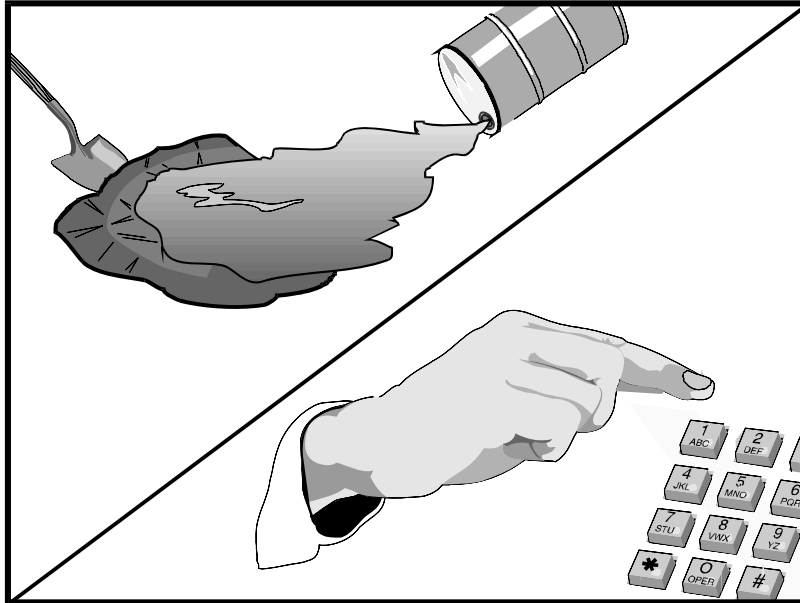

Description and Purpose

Prevent or reduce the discharge of pollutants to drainage systems or watercourses from leaks and spills by reducing the chance for spills, stopping the source of spills, containing and cleaning up spills, properly disposing of spill materials, and training employees.

This best management practice covers only spill prevention and control. However, WM-1, Materials Delivery and Storage, and WM-2, Material Use, also contain useful information, particularly on spill prevention. For information on wastes, see the waste management BMPs in this section.

Suitable Applications

This BMP is suitable for all construction projects. Spill control procedures are implemented anytime chemicals or hazardous substances are stored on the construction site, including the following materials:

- Soil stabilizers/binders
- Dust palliatives
- Herbicides
- Growth inhibitors
- Fertilizers
- Deicing/anti-icing chemicals

Categories

EC	Erosion Control	
SE	Sediment Control	
TC	Tracking Control	
WE	Wind Erosion Control	
NS	Non-Stormwater Management Control	
WM	Waste Management and Materials Pollution Control	<input checked="" type="checkbox"/>

Legend:

- Primary Objective
- Secondary Objective

Targeted Constituents

Sediment	<input checked="" type="checkbox"/>
Nutrients	<input checked="" type="checkbox"/>
Trash	<input checked="" type="checkbox"/>
Metals	<input checked="" type="checkbox"/>
Bacteria	
Oil and Grease	<input checked="" type="checkbox"/>
Organics	<input checked="" type="checkbox"/>

Potential Alternatives

None



- Fuels
- Lubricants
- Other petroleum distillates

Limitations

- In some cases it may be necessary to use a private spill cleanup company.
- This BMP applies to spills caused by the contractor and subcontractors.
- Procedures and practices presented in this BMP are general. Contractor should identify appropriate practices for the specific materials used or stored onsite

Implementation

The following steps will help reduce the stormwater impacts of leaks and spills:

Education

- Be aware that different materials pollute in different amounts. Make sure that each employee knows what a “significant spill” is for each material they use, and what is the appropriate response for “significant” and “insignificant” spills.
- Educate employees and subcontractors on potential dangers to humans and the environment from spills and leaks.
- Hold regular meetings to discuss and reinforce appropriate disposal procedures (incorporate into regular safety meetings).
- Establish a continuing education program to indoctrinate new employees.
- Have contractor’s superintendent or representative oversee and enforce proper spill prevention and control measures.

General Measures

- To the extent that the work can be accomplished safely, spills of oil, petroleum products, substances listed under 40 CFR parts 110,117, and 302, and sanitary and septic wastes should be contained and cleaned up immediately.
- Store hazardous materials and wastes in covered containers and protect from vandalism.
- Place a stockpile of spill cleanup materials where it will be readily accessible.
- Train employees in spill prevention and cleanup.
- Designate responsible individuals to oversee and enforce control measures.
- Spills should be covered and protected from stormwater runoff during rainfall to the extent that it doesn’t compromise clean up activities.
- Do not bury or wash spills with water.

- Store and dispose of used clean up materials, contaminated materials, and recovered spill material that is no longer suitable for the intended purpose in conformance with the provisions in applicable BMPs.
- Do not allow water used for cleaning and decontamination to enter storm drains or watercourses. Collect and dispose of contaminated water in accordance with WM-10, Liquid Waste Management.
- Contain water overflow or minor water spillage and do not allow it to discharge into drainage facilities or watercourses.
- Place proper storage, cleanup, and spill reporting instructions for hazardous materials stored or used on the project site in an open, conspicuous, and accessible location.
- Keep waste storage areas clean, well organized, and equipped with ample cleanup supplies as appropriate for the materials being stored. Perimeter controls, containment structures, covers, and liners should be repaired or replaced as needed to maintain proper function.

Cleanup

- Clean up leaks and spills immediately.
- Use a rag for small spills on paved surfaces, a damp mop for general cleanup, and absorbent material for larger spills. If the spilled material is hazardous, then the used cleanup materials are also hazardous and must be sent to either a certified laundry (rags) or disposed of as hazardous waste.
- Never hose down or bury dry material spills. Clean up as much of the material as possible and dispose of properly. See the waste management BMPs in this section for specific information.

Minor Spills

- Minor spills typically involve small quantities of oil, gasoline, paint, etc. which can be controlled by the first responder at the discovery of the spill.
- Use absorbent materials on small spills rather than hosing down or burying the spill.
- Absorbent materials should be promptly removed and disposed of properly.
- Follow the practice below for a minor spill:
 - Contain the spread of the spill.
 - Recover spilled materials.
 - Clean the contaminated area and properly dispose of contaminated materials.

Semi-Significant Spills

- Semi-significant spills still can be controlled by the first responder along with the aid of other personnel such as laborers and the foreman, etc. This response may require the cessation of all other activities.

- Spills should be cleaned up immediately:
 - Contain spread of the spill.
 - Notify the project foreman immediately.
 - If the spill occurs on paved or impermeable surfaces, clean up using "dry" methods (absorbent materials, cat litter and/or rags). Contain the spill by encircling with absorbent materials and do not let the spill spread widely.
 - If the spill occurs in dirt areas, immediately contain the spill by constructing an earthen dike. Dig up and properly dispose of contaminated soil.
 - If the spill occurs during rain, cover spill with tarps or other material to prevent contaminating runoff.

Significant/Hazardous Spills

- For significant or hazardous spills that cannot be controlled by personnel in the immediate vicinity, the following steps should be taken:
 - Notify the local emergency response by dialing 911. In addition to 911, the contractor will notify the proper county officials. It is the contractor's responsibility to have all emergency phone numbers at the construction site.
 - Notify the Governor's Office of Emergency Services Warning Center, (916) 845-8911.
 - For spills of federal reportable quantities, in conformance with the requirements in 40 CFR parts 110,119, and 302, the contractor should notify the National Response Center at (800) 424-8802.
 - Notification should first be made by telephone and followed up with a written report.
 - The services of a spills contractor or a Haz-Mat team should be obtained immediately. Construction personnel should not attempt to clean up until the appropriate and qualified staffs have arrived at the job site.
 - Other agencies which may need to be consulted include, but are not limited to, the Fire Department, the Public Works Department, the Coast Guard, the Highway Patrol, the City/County Police Department, Department of Toxic Substances, California Division of Oil and Gas, Cal/OSHA, etc.

Reporting

- Report significant spills to local agencies, such as the Fire Department; they can assist in cleanup.
- Federal regulations require that any significant oil spill into a water body or onto an adjoining shoreline be reported to the National Response Center (NRC) at 800-424-8802 (24 hours).

Use the following measures related to specific activities:

Vehicle and Equipment Maintenance

- If maintenance must occur onsite, use a designated area and a secondary containment, located away from drainage courses, to prevent the runoff of stormwater and the runoff of spills.
- Regularly inspect onsite vehicles and equipment for leaks and repair immediately
- Check incoming vehicles and equipment (including delivery trucks, and employee and subcontractor vehicles) for leaking oil and fluids. Do not allow leaking vehicles or equipment onsite.
- Always use secondary containment, such as a drain pan or drop cloth, to catch spills or leaks when removing or changing fluids.
- Place drip pans or absorbent materials under paving equipment when not in use.
- Use absorbent materials on small spills rather than hosing down or burying the spill. Remove the absorbent materials promptly and dispose of properly.
- Promptly transfer used fluids to the proper waste or recycling drums. Don't leave full drip pans or other open containers lying around
- Oil filters disposed of in trashcans or dumpsters can leak oil and pollute stormwater. Place the oil filter in a funnel over a waste oil-recycling drum to drain excess oil before disposal. Oil filters can also be recycled. Ask the oil supplier or recycler about recycling oil filters.
- Store cracked batteries in a non-leaking secondary container. Do this with all cracked batteries even if you think all the acid has drained out. If you drop a battery, treat it as if it is cracked. Put it into the containment area until you are sure it is not leaking.

Vehicle and Equipment Fueling

- If fueling must occur onsite, use designate areas, located away from drainage courses, to prevent the runoff of stormwater and the runoff of spills.
- Discourage “topping off” of fuel tanks.
- Always use secondary containment, such as a drain pan, when fueling to catch spills/ leaks.

Costs

Prevention of leaks and spills is inexpensive. Treatment and/ or disposal of contaminated soil or water can be quite expensive.

Inspection and Maintenance

- Inspect and verify that activity-based BMPs are in place prior to the commencement of associated activities. While activities associated with the BMP are under way, inspect weekly during the rainy season and of two-week intervals in the non-rainy season to verify continued BMP implementation.
- Inspect BMPs subject to non-stormwater discharge daily while non-stormwater discharges occur.

- Keep ample supplies of spill control and cleanup materials onsite, near storage, unloading, and maintenance areas.
- Update your spill prevention and control plan and stock cleanup materials as changes occur in the types of chemicals onsite.

References

Blueprint for a Clean Bay: Best Management Practices to Prevent Stormwater Pollution from Construction Related Activities; Santa Clara Valley Nonpoint Source Pollution Control Program, 1995.

Stormwater Quality Handbooks - Construction Site Best Management Practices (BMPs) Manual, State of California Department of Transportation (Caltrans), November 2000.

Stormwater Management for Construction Activities; Developing Pollution Prevention Plans and Best Management Practice, EPA 832-R-92005; USEPA, April 1992.

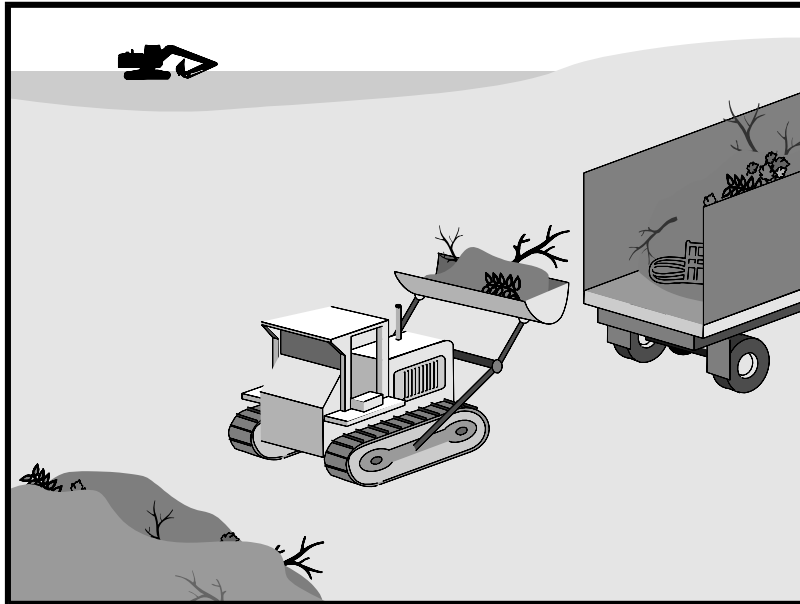

Description and Purpose

Solid waste management procedures and practices are designed to prevent or reduce the discharge of pollutants to stormwater from solid or construction waste by providing designated waste collection areas and containers, arranging for regular disposal, and training employees and subcontractors.

Suitable Applications

This BMP is suitable for construction sites where the following wastes are generated or stored:

- Solid waste generated from trees and shrubs removed during land clearing, demolition of existing structures (rubble), and building construction
- Packaging materials including wood, paper, and plastic
- Scrap or surplus building materials including scrap metals, rubber, plastic, glass pieces and masonry products
- Domestic wastes including food containers such as beverage cans, coffee cups, paper bags, plastic wrappers, and cigarettes
- Construction wastes including brick, mortar, timber, steel and metal scraps, pipe and electrical cuttings, non-hazardous equipment parts, styrofoam and other materials used to transport and package construction materials
- Highway planting wastes, including vegetative material,

Categories

EC	Erosion Control	
SE	Sediment Control	
TC	Tracking Control	
WE	Wind Erosion Control	
NS	Non-Stormwater Management Control	
WM	Waste Management and Materials Pollution Control	<input checked="" type="checkbox"/>

Legend:

- Primary Objective**
- Secondary Objective**

Targeted Constituents

Sediment	<input checked="" type="checkbox"/>
Nutrients	<input checked="" type="checkbox"/>
Trash	<input checked="" type="checkbox"/>
Metals	<input checked="" type="checkbox"/>
Bacteria	
Oil and Grease	<input checked="" type="checkbox"/>
Organics	<input checked="" type="checkbox"/>

Potential Alternatives

None



plant containers, and packaging materials

Limitations

Temporary stockpiling of certain construction wastes may not necessitate stringent drainage related controls during the non-rainy season or in desert areas with low rainfall.

Implementation

The following steps will help keep a clean site and reduce stormwater pollution:

- Select designated waste collection areas onsite.
- Inform trash-hauling contractors that you will accept only watertight dumpsters for onsite use. Inspect dumpsters for leaks and repair any dumpster that is not watertight.
- Locate containers in a covered area or in a secondary containment.
- Provide an adequate number of containers with lids or covers that can be placed over the container to keep rain out or to prevent loss of wastes when it is windy.
- Plan for additional containers and more frequent pickup during the demolition phase of construction.
- Collect site trash daily, especially during rainy and windy conditions.
- Remove this solid waste promptly since erosion and sediment control devices tend to collect litter.
- Make sure that toxic liquid wastes (used oils, solvents, and paints) and chemicals (acids, pesticides, additives, curing compounds) are not disposed of in dumpsters designated for construction debris.
- Do not hose out dumpsters on the construction site. Leave dumpster cleaning to the trash hauling contractor.
- Arrange for regular waste collection before containers overflow.
- Clean up immediately if a container does spill.
- Make sure that construction waste is collected, removed, and disposed of only at authorized disposal areas.

Education

- Have the contractor's superintendent or representative oversee and enforce proper solid waste management procedures and practices.
- Instruct employees and subcontractors on identification of solid waste and hazardous waste.
- Educate employees and subcontractors on solid waste storage and disposal procedures.
- Hold regular meetings to discuss and reinforce disposal procedures (incorporate into regular safety meetings).

- Require that employees and subcontractors follow solid waste handling and storage procedures.
- Prohibit littering by employees, subcontractors, and visitors.
- Minimize production of solid waste materials wherever possible.

Collection, Storage, and Disposal

- Littering on the project site should be prohibited.
- To prevent clogging of the storm drainage system, litter and debris removal from drainage grates, trash racks, and ditch lines should be a priority.
- Trash receptacles should be provided in the contractor's yard, field trailer areas, and at locations where workers congregate for lunch and break periods.
- Litter from work areas within the construction limits of the project site should be collected and placed in watertight dumpsters at least weekly, regardless of whether the litter was generated by the contractor, the public, or others. Collected litter and debris should not be placed in or next to drain inlets, stormwater drainage systems, or watercourses.
- Dumpsters of sufficient size and number should be provided to contain the solid waste generated by the project.
- Full dumpsters should be removed from the project site and the contents should be disposed of by the trash hauling contractor.
- Construction debris and waste should be removed from the site biweekly or more frequently as needed.
- Construction material visible to the public should be stored or stacked in an orderly manner.
- Stormwater runoff should be prevented from contacting stored solid waste through the use of berms, dikes, or other temporary diversion structures or through the use of measures to elevate waste from site surfaces.
- Solid waste storage areas should be located at least 50 ft from drainage facilities and watercourses and should not be located in areas prone to flooding or ponding.
- Except during fair weather, construction and highway planting waste not stored in watertight dumpsters should be securely covered from wind and rain by covering the waste with tarps or plastic.
- Segregate potentially hazardous waste from non-hazardous construction site waste.
- Make sure that toxic liquid wastes (used oils, solvents, and paints) and chemicals (acids, pesticides, additives, curing compounds) are not disposed of in dumpsters designated for construction debris.
- For disposal of hazardous waste, see WM-6, Hazardous Waste Management. Have hazardous waste hauled to an appropriate disposal and/or recycling facility.

- Salvage or recycle useful vegetation debris, packaging and surplus building materials when practical. For example, trees and shrubs from land clearing can be used as a brush barrier, or converted into wood chips, then used as mulch on graded areas. Wood pallets, cardboard boxes, and construction scraps can also be recycled.

Costs

All of the above are low cost measures.

Inspection and Maintenance

- Inspect and verify that activity-based BMPs are in place prior to the commencement of associated activities. While activities associated with the BMP are under way, inspect weekly during the rainy season and of two-week intervals in the non-rainy season to verify continued BMP implementation.
- Inspect BMPs subject to non-stormwater discharge daily while non-stormwater discharges occur
- Inspect construction waste area regularly.
- Arrange for regular waste collection.

References

Processes, Procedures and Methods to Control Pollution Resulting from All Construction Activity, 430/9-73-007, USEPA, 1973.

Stormwater Quality Handbooks - Construction Site Best Management Practices (BMPs) Manual, State of California Department of Transportation (Caltrans), November 2000.

Stormwater Management for Construction Activities; Developing Pollution Prevention Plans and Best Management Practice, EPA 832-R-92005; USEPA, April 1992.

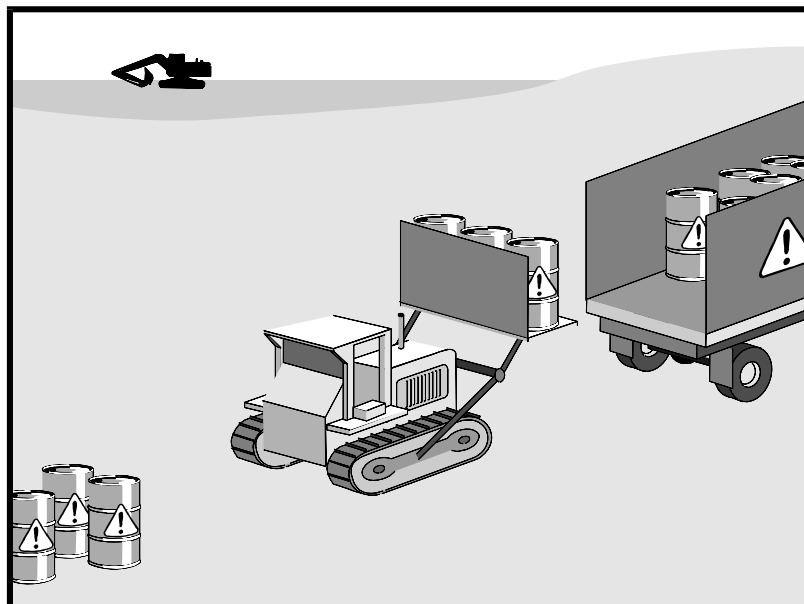

Description and Purpose

Prevent or reduce the discharge of pollutants to stormwater from hazardous waste through proper material use, waste disposal, and training of employees and subcontractors.

Suitable Applications

This best management practice (BMP) applies to all construction projects. Hazardous waste management practices are implemented on construction projects that generate waste from the use of:

- Petroleum Products
- Concrete Curing Compounds
- Palliatives
- Septic Wastes
- Stains
- Wood Preservatives
- Asphalt Products
- Pesticides
- Acids
- Paints
- Solvents
- Roofing Tar
- Any materials deemed a hazardous waste in California, Title 22 Division 4.5, or listed in 40 CFR Parts 110, 117, 261, or 302

Categories

EC	Erosion Control	
SE	Sediment Control	
TC	Tracking Control	
WE	Wind Erosion Control	
NS	Non-Stormwater Management Control	
WM	Waste Management and Materials Pollution Control	<input checked="" type="checkbox"/>

Legend:

- Primary Objective
- Secondary Objective

Targeted Constituents

Sediment	
Nutrients	<input checked="" type="checkbox"/>
Trash	<input checked="" type="checkbox"/>
Metals	<input checked="" type="checkbox"/>
Bacteria	<input checked="" type="checkbox"/>
Oil and Grease	<input checked="" type="checkbox"/>
Organics	<input checked="" type="checkbox"/>

Potential Alternatives

None



In addition, sites with existing structures may contain wastes, which must be disposed of in accordance with federal, state, and local regulations. These wastes include:

- Sandblasting grit mixed with lead-, cadmium-, or chromium-based paints
- Asbestos
- PCBs (particularly in older transformers)

Limitations

- Hazardous waste that cannot be reused or recycled must be disposed of by a licensed hazardous waste hauler.
- Nothing in this BMP relieves the contractor from responsibility for compliance with federal, state, and local laws regarding storage, handling, transportation, and disposal of hazardous wastes.
- This BMP does not cover aerially deposited lead (ADL) soils. For ADL soils refer to WM-7, Contaminated Soil Management.

Implementation

The following steps will help reduce stormwater pollution from hazardous wastes:

Material Use

- Wastes should be stored in sealed containers constructed of a suitable material and should be labeled as required by Title 22 CCR, Division 4.5 and 49 CFR Parts 172, 173, 178, and 179.
- All hazardous waste should be stored, transported, and disposed as required in Title 22 CCR, Division 4.5 and 49 CFR 261-263.
- Waste containers should be stored in temporary containment facilities that should comply with the following requirements:
 - Temporary containment facility should provide for a spill containment volume equal to 1.5 times the volume of all containers able to contain precipitation from a 25 year storm event, plus the greater of 10% of the aggregate volume of all containers or 100% of the capacity of the largest tank within its boundary, whichever is greater.
 - Temporary containment facility should be impervious to the materials stored there for a minimum contact time of 72 hours.
 - Temporary containment facilities should be maintained free of accumulated rainwater and spills. In the event of spills or leaks, accumulated rainwater and spills should be placed into drums after each rainfall. These liquids should be handled as a hazardous waste unless testing determines them to be non-hazardous. Non-hazardous liquids should be sent to an approved disposal site.
 - Sufficient separation should be provided between stored containers to allow for spill cleanup and emergency response access.

- Incompatible materials, such as chlorine and ammonia, should not be stored in the same temporary containment facility.
- Throughout the rainy season, temporary containment facilities should be covered during non-working days, and prior to rain events. Covered facilities may include use of plastic tarps for small facilities or constructed roofs with overhangs.
- Drums should not be overfilled and wastes should not be mixed.
- Unless watertight, containers of dry waste should be stored on pallets.
- Do not over-apply herbicides and pesticides. Prepare only the amount needed. Follow the recommended usage instructions. Over application is expensive and environmentally harmful. Apply surface dressings in several smaller applications, as opposed to one large application. Allow time for infiltration and avoid excess material being carried offsite by runoff. Do not apply these chemicals just before it rains. People applying pesticides must be certified in accordance with federal and state regulations.
- Paint brushes and equipment for water and oil based paints should be cleaned within a contained area and should not be allowed to contaminate site soils, watercourses, or drainage systems. Waste paints, thinners, solvents, residues, and sludges that cannot be recycled or reused should be disposed of as hazardous waste. When thoroughly dry, latex paint and paint cans, used brushes, rags, absorbent materials, and drop cloths should be disposed of as solid waste.
- Do not clean out brushes or rinse paint containers into the dirt, street, gutter, storm drain, or stream. “Paint out” brushes as much as possible. Rinse water-based paints to the sanitary sewer. Filter and reuse thinners and solvents. Dispose of excess oil-based paints and sludge as hazardous waste.
- The following actions should be taken with respect to temporary contaminant:
 - Ensure that adequate hazardous waste storage volume is available.
 - Ensure that hazardous waste collection containers are conveniently located.
 - Designate hazardous waste storage areas onsite away from storm drains or watercourses and away from moving vehicles and equipment to prevent accidental spills.
 - Minimize production or generation of hazardous materials and hazardous waste on the job site.
 - Use containment berms in fueling and maintenance areas and where the potential for spills is high.
 - Segregate potentially hazardous waste from non-hazardous construction site debris.
 - Keep liquid or semi-liquid hazardous waste in appropriate containers (closed drums or similar) and under cover.

- Clearly label all hazardous waste containers with the waste being stored and the date of accumulation.
- Place hazardous waste containers in secondary containment.
- Do not allow potentially hazardous waste materials to accumulate on the ground.
- Do not mix wastes.
- Use all of the product before disposing of the container.
- Do not remove the original product label; it contains important safety and disposal information.

Waste Recycling Disposal

- Select designated hazardous waste collection areas onsite.
- Hazardous materials and wastes should be stored in covered containers and protected from vandalism.
- Place hazardous waste containers in secondary containment.
- Do not mix wastes, this can cause chemical reactions, making recycling impossible and complicating disposal.
- Recycle any useful materials such as used oil or water-based paint.
- Make sure that toxic liquid wastes (used oils, solvents, and paints) and chemicals (acids, pesticides, additives, curing compounds) are not disposed of in dumpsters designated for construction debris.
- Arrange for regular waste collection before containers overflow.
- Make sure that hazardous waste (e.g., excess oil-based paint and sludge) is collected, removed, and disposed of only at authorized disposal areas.

Disposal Procedures

- Waste should be disposed of by a licensed hazardous waste transporter at an authorized and licensed disposal facility or recycling facility utilizing properly completed Uniform Hazardous Waste Manifest forms.
- A Department of Health Services certified laboratory should sample waste to determine the appropriate disposal facility.
- Properly dispose of rainwater in secondary containment that may have mixed with hazardous waste.
- Attention is directed to "Hazardous Material", "Contaminated Material", and "Aerially Deposited Lead" of the contract documents regarding the handling and disposal of hazardous materials.

Education

- Educate employees and subcontractors on hazardous waste storage and disposal procedures.
- Educate employees and subcontractors on potential dangers to humans and the environment from hazardous wastes.
- Instruct employees and subcontractors on safety procedures for common construction site hazardous wastes.
- Instruct employees and subcontractors in identification of hazardous and solid waste.
- Hold regular meetings to discuss and reinforce hazardous waste management procedures (incorporate into regular safety meetings).
- The contractor's superintendent or representative should oversee and enforce proper hazardous waste management procedures and practices.
- Make sure that hazardous waste is collected, removed, and disposed of only at authorized disposal areas.
- Warning signs should be placed in areas recently treated with chemicals.
- Place a stockpile of spill cleanup materials where it will be readily accessible.
- If a container does spill, clean up immediately.

Costs

All of the above are low cost measures.

Inspection and Maintenance

- Inspect and verify that activity-based BMPs are in place prior to the commencement of associated activities. While activities associated with the BMP are under way, inspect weekly during the rainy season and of two week intervals in the non-rainy season to verify continued BMP implementation.
- Inspect BMPs subject to non-stormwater discharge daily while non-stormwater discharges occur
- Hazardous waste should be regularly collected.
- A foreman or construction supervisor should monitor onsite hazardous waste storage and disposal procedures.
- Waste storage areas should be kept clean, well organized, and equipped with ample cleanup supplies as appropriate for the materials being stored.
- Perimeter controls, containment structures, covers, and liners should be repaired or replaced as needed to maintain proper function.
- Hazardous spills should be cleaned up and reported in conformance with the applicable Material Safety Data Sheet (MSDS) and the instructions posted at the project site.

- The National Response Center, at (800) 424-8802, should be notified of spills of federal reportable quantities in conformance with the requirements in 40 CFR parts 110, 117, and 302. Also notify the Governors Office of Emergency Services Warning Center at (916) 845-8911.
- A copy of the hazardous waste manifests should be provided.

References

Blueprint for a Clean Bay: Best Management Practices to Prevent Stormwater Pollution from Construction Related Activities; Santa Clara Valley Nonpoint Source Pollution Control Program, 1995.

Processes, Procedures and Methods to Control Pollution Resulting from All Construction Activity, 430/9-73-007, USEPA, 1973.

Stormwater Quality Handbooks - Construction Site Best Management Practices (BMPs) Manual, State of California Department of Transportation (Caltrans), November 2000.

Stormwater Management for Construction Activities; Developing Pollution Prevention Plans and Best Management Practice, EPA 832-R-92005; USEPA, April 1992.

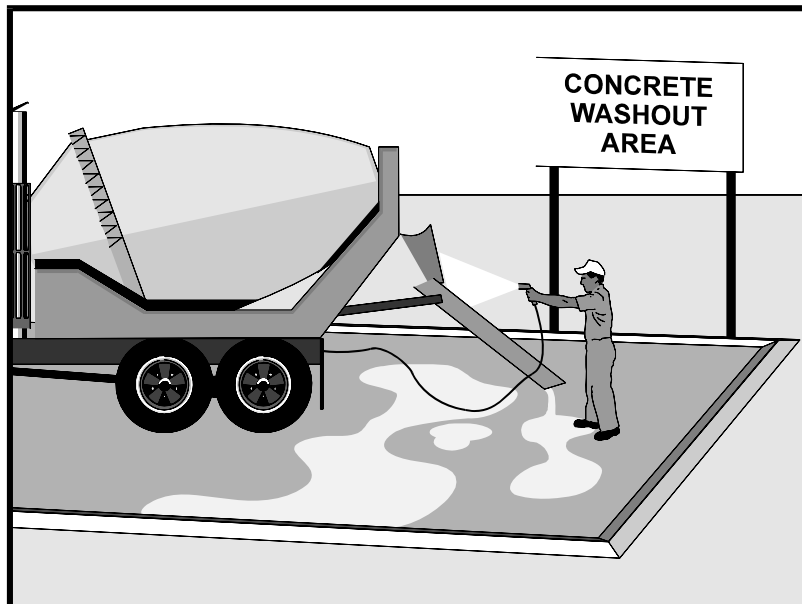

Description and Purpose

Prevent the discharge of pollutants to stormwater from concrete waste by conducting washout onsite or offsite in a designated area, and by employee and subcontractor training.

The General Permit incorporates Numeric Effluent Limits (NEL) and Numeric Action Levels (NAL) for pH (see Section 2 of this handbook to determine your project's risk level and if you are subject to these requirements).

Many types of construction materials, including mortar, concrete, stucco, cement and block and their associated wastes have basic chemical properties that can raise pH levels outside of the permitted range. Additional care should be taken when managing these materials to prevent them from coming into contact with stormwater flows and raising pH to levels outside the accepted range.

Suitable Applications

Concrete waste management procedures and practices are implemented on construction projects where:

- Concrete is used as a construction material or where concrete dust and debris result from demolition activities.
- Slurries containing portland cement concrete (PCC) are generated, such as from saw cutting, coring, grinding, grooving, and hydro-concrete demolition.

Categories

EC	Erosion Control	
SE	Sediment Control	
TC	Tracking Control	
WE	Wind Erosion Control	
NS	Non-Stormwater Management Control	<input checked="" type="checkbox"/>
WM	Waste Management and Materials Pollution Control	<input checked="" type="checkbox"/>

Legend:

- Primary Category
- Secondary Category

Targeted Constituents

Sediment	<input checked="" type="checkbox"/>
Nutrients	
Trash	
Metals	<input checked="" type="checkbox"/>
Bacteria	
Oil and Grease	
Organics	

Potential Alternatives

None



- Concrete trucks and other concrete-coated equipment are washed onsite.
- Mortar-mixing stations exist.
- Stucco mixing and spraying .
- See also NS-8, Vehicle and Equipment Cleaning.

Limitations

- Offsite washout of concrete wastes may not always be possible.
- Multiple washouts may be needed to assure adequate capacity and to allow for evaporation.

Implementation

The following steps will help reduce stormwater pollution from concrete wastes:

- Incorporate requirements for concrete waste management into material supplier and subcontractor agreements.
- Store dry and wet materials under cover, away from drainage areas. Refer to WM-1, Material Delivery and Storage for more information.
- Avoid mixing excess amounts of concrete.
- Perform washout of concrete trucks in designated areas only, where washout will not reach stormwater.
- Do not wash out concrete trucks into storm drains, open ditches, streets, streams or onto the ground. Trucks should always be washed out into designated facilities.
- Do not allow excess concrete to be dumped onsite, except in designated areas.
- For onsite washout:
 - On larger sites, it is recommended to locate washout areas at least 50 feet from storm drains, open ditches, or water bodies. Do not allow runoff from this area by constructing a temporary pit or bermed area large enough for liquid and solid waste.
 - Washout wastes into the temporary washout where the concrete can set, be broken up, and then disposed properly.
 - Washout should be lined so there is no discharge into the underlying soil.
- Do not wash sweepings from exposed aggregate concrete into the street or storm drain. Collect and return sweepings to aggregate base stockpile or dispose in the trash.
- See typical concrete washout installation details at the end of this fact sheet.

Education

- Educate employees, subcontractors, and suppliers on the concrete waste management techniques described herein.

- Arrange for contractor's superintendent or representative to oversee and enforce concrete waste management procedures.
- Discuss the concrete management techniques described in this BMP (such as handling of concrete waste and washout) with the ready-mix concrete supplier before any deliveries are made.

Concrete Demolition Wastes

- Stockpile concrete demolition waste in accordance with BMP WM-3, Stockpile Management.
- Dispose of or recycle hardened concrete waste in accordance with applicable federal, state or local regulations.

Concrete Slurry Wastes

- PCC and AC waste should not be allowed to enter storm drains or watercourses.
- PCC and AC waste should be collected and disposed of or placed in a temporary concrete washout facility (as described in Onsite Temporary Concrete Washout Facility, Concrete Transit Truck Washout Procedures, below).
- A foreman or construction supervisor should monitor onsite concrete working tasks, such as saw cutting, coring, grinding and grooving to ensure proper methods are implemented.
- Saw-cut concrete slurry should not be allowed to enter storm drains or watercourses. Residue from grinding operations should be picked up by means of a vacuum attachment to the grinding machine or by sweeping. Saw cutting residue should not be allowed to flow across the pavement and should not be left on the surface of the pavement. See also NS-3, Paving and Grinding Operations; and WM-10, Liquid Waste Management.
- Concrete slurry residue should be disposed in a temporary washout facility (as described in Onsite Temporary Concrete Washout Facility, Concrete Transit Truck Washout Procedures, below) and allowed to dry. Dispose of dry slurry residue in accordance with WM-5, Solid Waste Management.

Onsite Temporary Concrete Washout Facility, Transit Truck Washout Procedures

- Temporary concrete washout facilities should be located a minimum of 50 ft from storm drain inlets, open drainage facilities, and watercourses. Each facility should be located away from construction traffic or access areas to prevent disturbance or tracking.
- A sign should be installed adjacent to each washout facility to inform concrete equipment operators to utilize the proper facilities.
- Temporary concrete washout facilities should be constructed above grade or below grade at the option of the contractor. Temporary concrete washout facilities should be constructed and maintained in sufficient quantity and size to contain all liquid and concrete waste generated by washout operations.

- Temporary washout facilities should have a temporary pit or bermed areas of sufficient volume to completely contain all liquid and waste concrete materials generated during washout procedures.
- Temporary washout facilities should be lined to prevent discharge to the underlying ground or surrounding area.
- Washout of concrete trucks should be performed in designated areas only.
- Only concrete from mixer truck chutes should be washed into concrete wash out.
- Concrete washout from concrete pumper bins can be washed into concrete pumper trucks and discharged into designated washout area or properly disposed of or recycled offsite.
- Once concrete wastes are washed into the designated area and allowed to harden, the concrete should be broken up, removed, and disposed of per WM-5, Solid Waste Management. Dispose of or recycle hardened concrete on a regular basis.
- Temporary Concrete Washout Facility (Type Above Grade)
 - Temporary concrete washout facility (type above grade) should be constructed as shown on the details at the end of this BMP, with a recommended minimum length and minimum width of 10 ft; however, smaller sites or jobs may only need a smaller washout facility. With any washout, always maintain a sufficient quantity and volume to contain all liquid and concrete waste generated by washout operations.
 - Materials used to construct the washout area should conform to the provisions detailed in their respective BMPs (e.g., SE-8 Sandbag Barrier).
 - Plastic lining material should be a minimum of 10 mil in polyethylene sheeting and should be free of holes, tears, or other defects that compromise the impermeability of the material.
 - Alternatively, portable removable containers can be used as above grade concrete washouts. Also called a “roll-off”; this concrete washout facility should be properly sealed to prevent leakage, and should be removed from the site and replaced when the container reaches 75% capacity.
- Temporary Concrete Washout Facility (Type Below Grade)
 - Temporary concrete washout facilities (type below grade) should be constructed as shown on the details at the end of this BMP, with a recommended minimum length and minimum width of 10 ft. The quantity and volume should be sufficient to contain all liquid and concrete waste generated by washout operations.
 - Lath and flagging should be commercial type.
 - Plastic lining material should be a minimum of 10 mil polyethylene sheeting and should be free of holes, tears, or other defects that compromise the impermeability of the material.

- The base of a washout facility should be free of rock or debris that may damage a plastic liner.

Removal of Temporary Concrete Washout Facilities

- When temporary concrete washout facilities are no longer required for the work, the hardened concrete should be removed and properly disposed or recycled in accordance with federal, state or local regulations. Materials used to construct temporary concrete washout facilities should be removed from the site of the work and properly disposed or recycled in accordance with federal, state or local regulations..
- Holes, depressions or other ground disturbance caused by the removal of the temporary concrete washout facilities should be backfilled and repaired.

Costs

All of the above are low cost measures. Roll-off concrete washout facilities can be more costly than other measures due to removal and replacement; however, provide a cleaner alternative to traditional washouts. The type of washout facility, size, and availability of materials will determine the cost of the washout.

Inspection and Maintenance

- BMPs must be inspected in accordance with General Permit requirements for the associated project type and risk level. It is recommended that at a minimum, BMPs be inspected weekly, prior to forecasted rain events, daily during extended rain events, and after the conclusion of rain events.
- Temporary concrete washout facilities should be maintained to provide adequate holding capacity with a minimum freeboard of 4 in. for above grade facilities and 12 in. for below grade facilities. Maintaining temporary concrete washout facilities should include removing and disposing of hardened concrete and returning the facilities to a functional condition. Hardened concrete materials should be removed and properly disposed or recycled in accordance with federal, state or local regulations.
- Washout facilities must be cleaned, or new facilities must be constructed and ready for use once the washout is 75% full.
- Inspect washout facilities for damage (e.g. torn liner, evidence of leaks, signage, etc.). Repair all identified damage.

References

Blueprint for a Clean Bay: Best Management Practices to Prevent Stormwater Pollution from Construction Related Activities; Santa Clara Valley Nonpoint Source Pollution Control Program, 1995.

Stormwater Quality Handbooks - Construction Site Best Management Practices (BMPs) Manual, State of California Department of Transportation (Caltrans), November 2000, Updated March 2003.

Stormwater Management for Construction Activities; Developing Pollution Prevention Plans and Best Management Practice, EPA 832-R-92005; USEPA, April 1992.

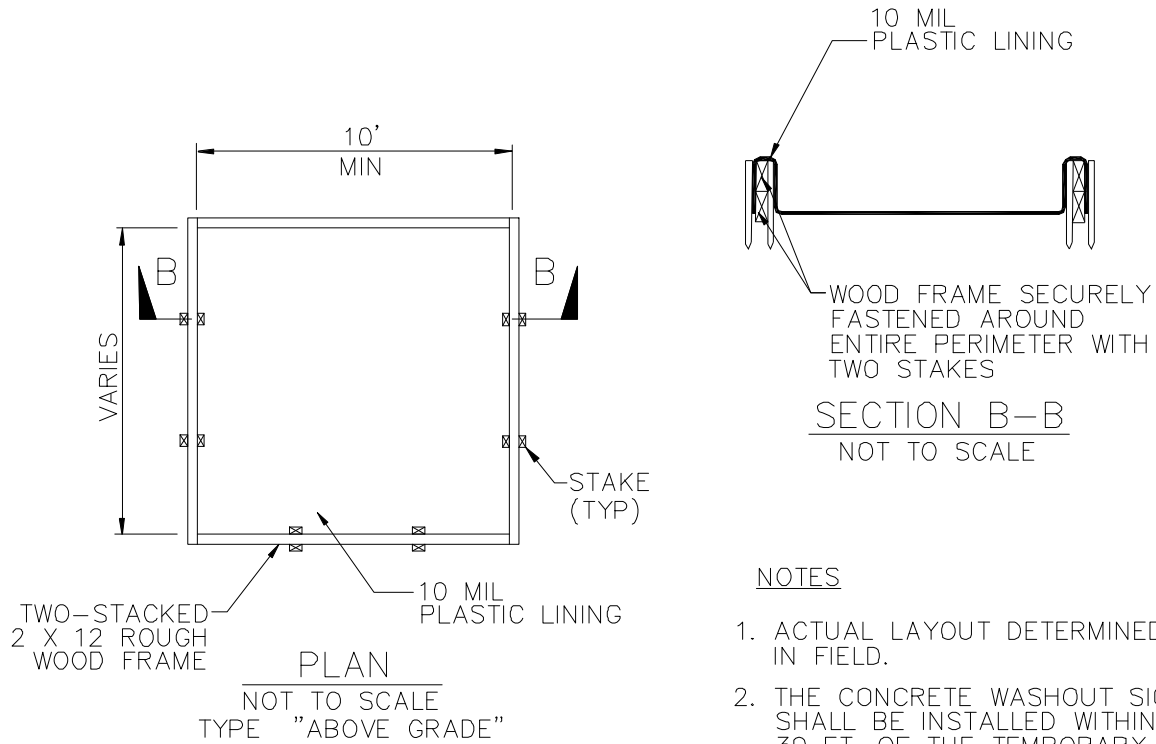
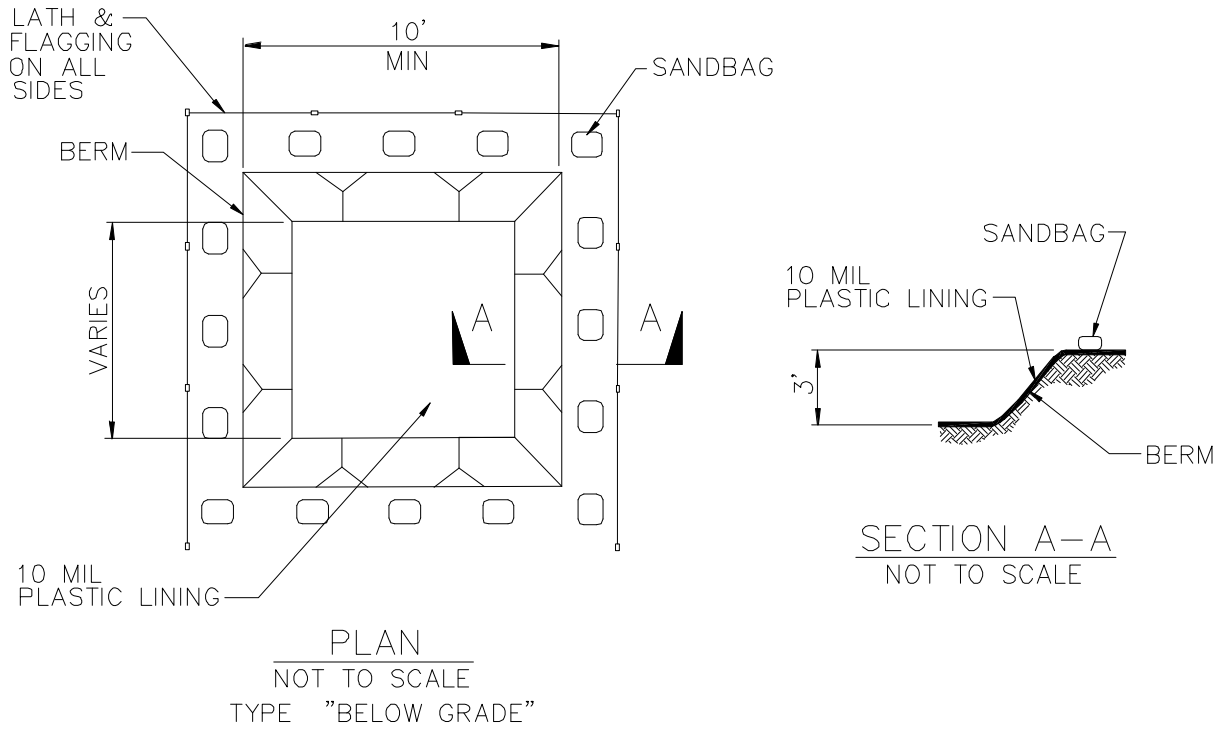

NOTES

1. ACTUAL LAYOUT DETERMINED IN FIELD.
2. THE CONCRETE WASHOUT SIGN SHALL BE INSTALLED WITHIN 30 FT. OF THE TEMPORARY CONCRETE WASHOUT FACILITY.

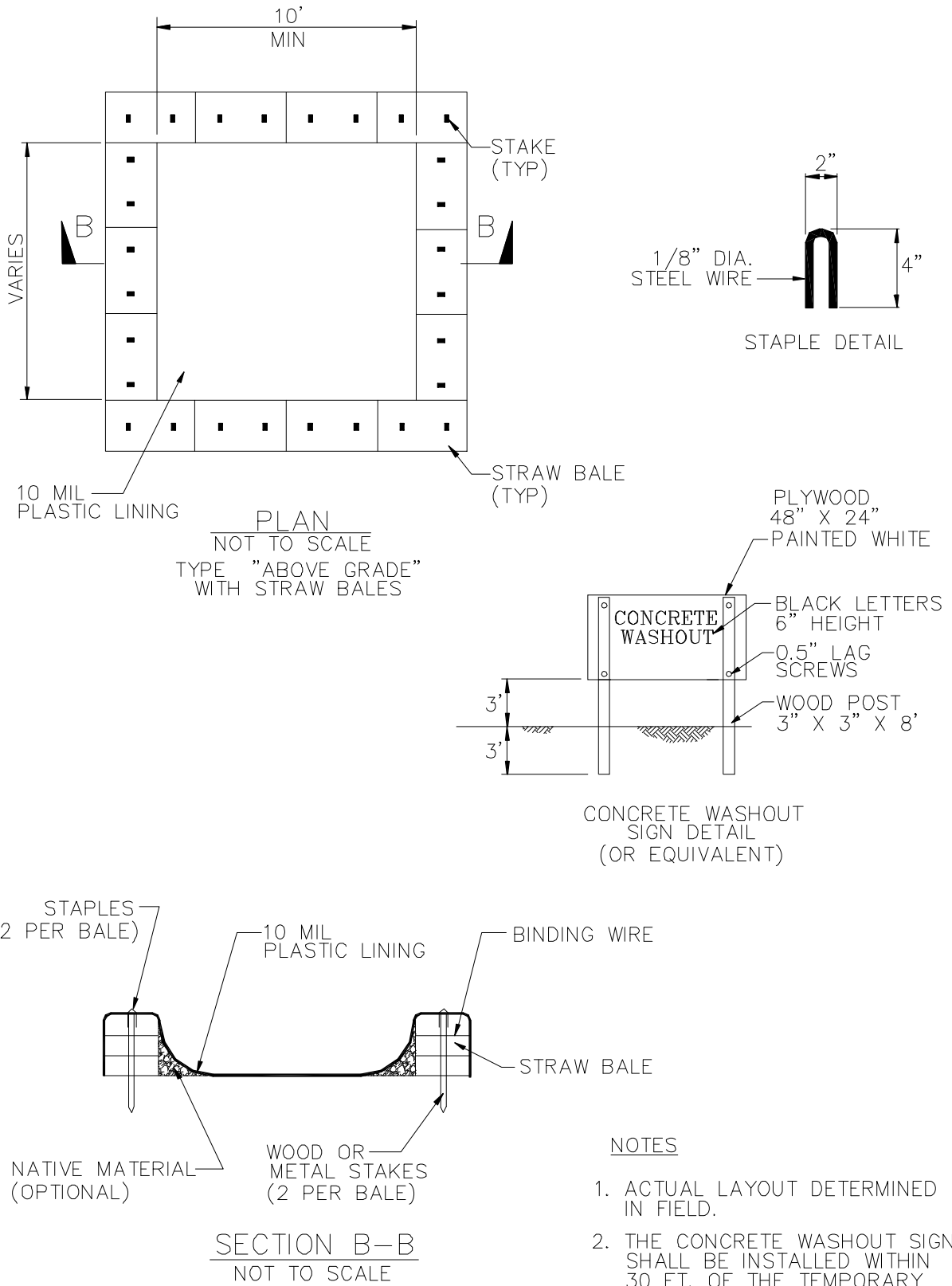

Sanitary/Septic Waste Management WM-9

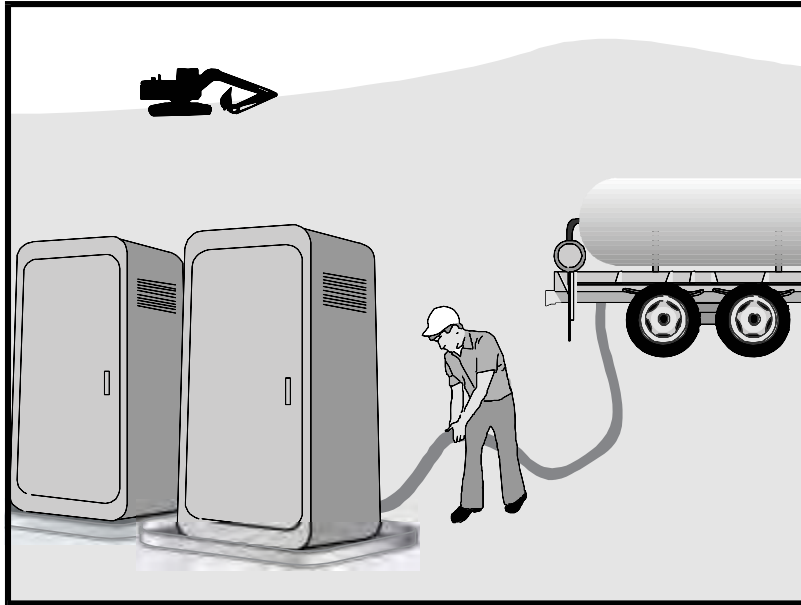

Description and Purpose

Proper sanitary and septic waste management prevent the discharge of pollutants to stormwater from sanitary and septic waste by providing convenient, well-maintained facilities, and arranging for regular service and disposal.

Suitable Applications

Sanitary septic waste management practices are suitable for use at all construction sites that use temporary or portable sanitary and septic waste systems.

Limitations

None identified.

Implementation

Sanitary or septic wastes should be treated or disposed of in accordance with state and local requirements. In many cases, one contract with a local facility supplier will be all that it takes to make sure sanitary wastes are properly disposed.

Storage and Disposal Procedures

- Temporary sanitary facilities should be located away from drainage facilities, watercourses, and from traffic circulation. If site conditions allow, place portable facilities a minimum of 50 feet from drainage conveyances and traffic areas. When subjected to high winds or risk of high winds, temporary sanitary facilities should be secured to prevent overturning.

Categories

EC	Erosion Control	
SE	Sediment Control	
TC	Tracking Control	
WE	Wind Erosion Control	
NS	Non-Stormwater Management Control	
WM	Waste Management and Materials Pollution Control	<input checked="" type="checkbox"/>

Legend:

- Primary Category
- Secondary Category

Targeted Constituents

Sediment	
Nutrients	<input checked="" type="checkbox"/>
Trash	<input checked="" type="checkbox"/>
Metals	
Bacteria	<input checked="" type="checkbox"/>
Oil and Grease	
Organics	<input checked="" type="checkbox"/>

Potential Alternatives

None



Sanitary/Septic Waste Management WM-9

- Temporary sanitary facilities must be equipped with containment to prevent discharge of pollutants to the stormwater drainage system of the receiving water.
- Consider safety as well as environmental implications before placing temporary sanitary facilities.
- Wastewater should not be discharged or buried within the project site.
- Sanitary and septic systems that discharge directly into sanitary sewer systems, where permissible, should comply with the local health agency, city, county, and sewer district requirements.
- Only reputable, licensed sanitary and septic waste haulers should be used.
- Sanitary facilities should be located in a convenient location.
- Temporary septic systems should treat wastes to appropriate levels before discharging.
- If using an onsite disposal system (OSDS), such as a septic system, local health agency requirements must be followed.
- Temporary sanitary facilities that discharge to the sanitary sewer system should be properly connected to avoid illicit discharges.
- Sanitary and septic facilities should be maintained in good working order by a licensed service.
- Regular waste collection by a licensed hauler should be arranged before facilities overflow.
- If a spill does occur from a temporary sanitary facility, follow federal, state and local regulations for containment and clean-up.

Education

- Educate employees, subcontractors, and suppliers on sanitary and septic waste storage and disposal procedures.
- Educate employees, subcontractors, and suppliers of potential dangers to humans and the environment from sanitary and septic wastes.
- Instruct employees, subcontractors, and suppliers in identification of sanitary and septic waste.
- Hold regular meetings to discuss and reinforce the use of sanitary facilities (incorporate into regular safety meetings).
- Establish a continuing education program to indoctrinate new employees.

Costs

All of the above are low cost measures.

Sanitary/Septic Waste Management WM-9

Inspection and Maintenance

- BMPs must be inspected in accordance with General Permit requirements for the associated project type and risk level. It is recommended that at a minimum, BMPs be inspected weekly, prior to forecasted rain events, daily during extended rain events, and after the conclusion of rain events.
- Arrange for regular waste collection.
- If high winds are expected, portable sanitary facilities must be secured with spikes or weighed down to prevent over turning.
- If spills or leaks from sanitary or septic facilities occur that are not contained and discharge from the site, non-visible sampling of site discharge may be required. Refer to the General Permit or to your project specific Construction Site Monitoring Plan to determine if and where sampling is required.

References

Stormwater Quality Handbooks - Construction Site Best Management Practices (BMPs) Manual, State of California Department of Transportation (Caltrans), March 2003.

Stormwater Management for Construction Activities; Developing Pollution Prevention Plans and Best Management Practice, EPA 832-R-92005; USEPA, April 1992.

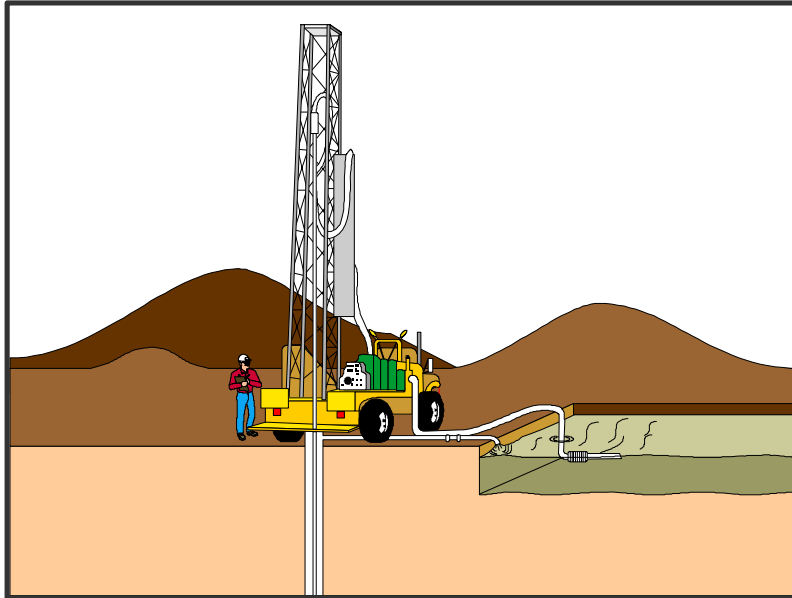

Description and Purpose

Liquid waste management includes procedures and practices to prevent discharge of pollutants to the storm drain system or to watercourses as a result of the creation, collection, and disposal of non-hazardous liquid wastes.

Suitable Applications

Liquid waste management is applicable to construction projects that generate any of the following non-hazardous by-products, residuals, or wastes:

- Drilling slurries and drilling fluids
- Grease-free and oil-free wastewater and rinse water
- Dredgings
- Other non-stormwater liquid discharges not permitted by separate permits

Limitations

- Disposal of some liquid wastes may be subject to specific laws and regulations or to requirements of other permits secured for the construction project (e.g., NPDES permits, Army Corps permits, Coastal Commission permits, etc.).
- Liquid waste management does not apply to dewatering operations (NS-2 Dewatering Operations), solid waste management (WM-5, Solid Waste Management), hazardous wastes (WM-6, Hazardous Waste Management), or concrete slurry residue (WM-8, Concrete Waste

Categories

EC	Erosion Control	
SE	Sediment Control	
TC	Tracking Control	
WE	Wind Erosion Control	
NS	Non-Stormwater Management Control	
WM	Waste Management and Materials Pollution Control	<input checked="" type="checkbox"/>

Legend:

- Primary Objective
- Secondary Objective

Targeted Constituents

Sediment	<input checked="" type="checkbox"/>
Nutrients	<input checked="" type="checkbox"/>
Trash	<input checked="" type="checkbox"/>
Metals	<input checked="" type="checkbox"/>
Bacteria	
Oil and Grease	<input checked="" type="checkbox"/>
Organics	

Potential Alternatives

None



Management).

- Typical permitted non-stormwater discharges can include: water line flushing; landscape irrigation; diverted stream flows; rising ground waters; uncontaminated pumped ground water; discharges from potable water sources; foundation drains; irrigation water; springs; water from crawl space pumps; footing drains; lawn watering; flows from riparian habitats and wetlands; and discharges or flows from emergency fire fighting activities.

Implementation

General Practices

- Instruct employees and subcontractors how to safely differentiate between non-hazardous liquid waste and potential or known hazardous liquid waste.
- Instruct employees, subcontractors, and suppliers that it is unacceptable for any liquid waste to enter any storm drainage device, waterway, or receiving water.
- Educate employees and subcontractors on liquid waste generating activities and liquid waste storage and disposal procedures.
- Hold regular meetings to discuss and reinforce disposal procedures (incorporate into regular safety meetings).
- Verify which non-stormwater discharges are permitted by the statewide NPDES permit; different regions might have different requirements not outlined in this permit.
- Apply NS-8, Vehicle and Equipment Cleaning for managing wash water and rinse water from vehicle and equipment cleaning operations.

Containing Liquid Wastes

- Drilling residue and drilling fluids should not be allowed to enter storm drains and watercourses and should be disposed of.
- If an appropriate location is available, drilling residue and drilling fluids that are exempt under Title 23, CCR § 2511(g) may be dried by infiltration and evaporation in a containment facility constructed in conformance with the provisions concerning the Temporary Concrete Washout Facilities detailed in WM-8, Concrete Waste Management.
- Liquid wastes generated as part of an operational procedure, such as water-laden dredged material and drilling mud, should be contained and not allowed to flow into drainage channels or receiving waters prior to treatment.
- Liquid wastes should be contained in a controlled area such as a holding pit, sediment basin, roll-off bin, or portable tank.
- Containment devices must be structurally sound and leak free.
- Containment devices must be of sufficient quantity or volume to completely contain the liquid wastes generated.

- Precautions should be taken to avoid spills or accidental releases of contained liquid wastes. Apply the education measures and spill response procedures outlined in WM-4, Spill Prevention and Control.
- Containment areas or devices should not be located where accidental release of the contained liquid can threaten health or safety or discharge to water bodies, channels, or storm drains.

Capturing Liquid Wastes

- Capture all liquid wastes that have the potential to affect the storm drainage system (such as wash water and rinse water from cleaning walls or pavement), before they run off a surface.
- Do not allow liquid wastes to flow or discharge uncontrolled. Use temporary dikes or berms to intercept flows and direct them to a containment area or device for capture.
- Use a sediment trap (SE-3, Sediment Trap) for capturing and treating sediment laden liquid waste or capture in a containment device and allow sediment to settle.

Disposing of Liquid Wastes

- A typical method to handle liquid waste is to dewater the contained liquid waste, using procedures such as described in NS-2, Dewatering Operations, and SE-2, Sediment Basin, and dispose of resulting solids per WM-5, Solid Waste Management.
- Methods of disposal for some liquid wastes may be prescribed in Water Quality Reports, NPDES permits, Environmental Impact Reports, 401 or 404 permits, and local agency discharge permits, etc. Review the SWPPP to see if disposal methods are identified.
- Liquid wastes, such as from dredged material, may require testing and certification whether it is hazardous or not before a disposal method can be determined.
- For disposal of hazardous waste, see WM-6, Hazardous Waste Management.
- If necessary, further treat liquid wastes prior to disposal. Treatment may include, though is not limited to, sedimentation, filtration, and chemical neutralization.

Costs

Prevention costs for liquid waste management are minimal. Costs increase if cleanup or fines are involved.

Inspection and Maintenance

- Inspect and verify that activity-based BMPs are in place prior to the commencement of associated activities. While activities associated with the BMP are under way, inspect weekly during the rainy season and of two-week intervals in the non-rainy season to verify continued BMP implementation.
- Inspect BMPs subject to non-stormwater discharge daily while non-stormwater discharges occur.

- Remove deposited solids in containment areas and capturing devices as needed and at the completion of the task. Dispose of any solids as described in WM-5, Solid Waste Management.
- Inspect containment areas and capturing devices and repair as needed.

References

Stormwater Quality Handbooks - Construction Site Best Management Practices (BMPs) Manual, State of California Department of Transportation (Caltrans), November 2000.

Appendix I: BMP Inspection Form

BMP INSPECTION REPORT

Date and Time of Inspection:		Date Report Written:		
Inspection Type: (Circle one)	<i>Weekly Complete Parts I,II,III and VII</i>	<i>Pre-Storm Complete Parts I,II,III,IV and VII</i>	<i>During Rain Event Complete Parts I, II, III, V, and VII</i>	<i>Post-Storm Complete Parts I,II,III,VI and VII</i>
Part I. General Information				
Site Information				
Construction Site Name:				
Construction stage and completed activities:			Approximate area of site that is exposed:	
Photos Taken: (Circle one)	Yes	No	Photo Reference IDs:	
Weather				
Estimate storm beginning: (date and time)		Estimate storm duration: (hours)		
Estimate time since last storm: (days or hours)		Rain gauge reading and location: (in)		
Is a "Qualifying Event" predicted or did one occur (i.e., 0.5" rain with 48-hrs or greater between events)? (Y/N) If yes, summarize forecast:				
Exemption Documentation (explanation required if inspection could not be conducted). Visual inspections are not required outside of business hours or during dangerous weather conditions such as flooding or electrical storms.				
Inspector Information				
Inspector Name:			Inspector Title:	
Signature:			Date:	

Part II. BMP Observations. Describe deficiencies in Part III.

Minimum BMPs for Risk Level _____ Sites	Failures or other short comings (yes, no, N/A)	Action Required (yes/no)	Action Implemented (Date)
Good Housekeeping for Construction Materials			
Inventory of products (excluding materials designed to be outdoors)			
Stockpiled construction materials not actively in use are covered and bermed			
All chemicals are stored in watertight containers with appropriate secondary containment, or in a completely enclosed storage shed			
Construction materials are minimally exposed to precipitation			
BMPs preventing the off-site tracking of materials are implemented and properly effective			
Good Housekeeping for Waste Management			
Wash/rinse water and materials are prevented from being disposed into the storm drain system			
Portable toilets are contained to prevent discharges of waste			
Sanitation facilities are clean and with no apparent for leaks and spills			
Equipment is in place to cover waste disposal containers at the end of business day and during rain events			
Discharges from waste disposal containers are prevented from discharging to the storm drain system / receiving water			
Stockpiled waste material is securely protected from wind and rain if not actively in use			
Procedures are in place for addressing hazardous and non-hazardous spills			
Appropriate spill response personnel are assigned and trained			
Equipment and materials for cleanup of spills is available onsite			
Washout areas (e.g., concrete) are contained appropriately to prevent discharge or infiltration into the underlying soil			
Good Housekeeping for Vehicle Storage and Maintenance			
Measures are in place to prevent oil, grease, or fuel from leaking into the ground, storm drains, or surface waters			
All equipment or vehicles are fueled, maintained, and stored in a designated area with appropriate BMPs			
Vehicle and equipment leaks are cleaned immediately and disposed of properly			

Part II. BMP Observations Continued. Describe deficiencies in Part III.			
Minimum BMPs for Risk Level _____ Sites	Adequately designed, implemented and effective (yes, no, N/A)	Action Required (yes/no)	Action Implemented (Date)
Good Housekeeping for Landscape Materials			
Stockpiled landscape materials such as mulches and topsoil are contained and covered when not actively in use			
Erodible landscape material has not been applied 2 days before a forecasted rain event or during an event			
Erodible landscape materials are applied at quantities and rates in accordance with manufacturer recommendations			
Bagged erodible landscape materials are stored on pallets and covered			
Good Housekeeping for Air Deposition of Site Materials			
Good housekeeping measures are implemented onsite to control the air deposition of site materials and from site operations			
Non-Stormwater Management			
Non-Stormwater discharges are properly controlled			
Vehicles are washed in a manner to prevent non-stormwater discharges to surface waters or drainage systems			
Streets are cleaned in a manner to prevent unauthorized non-stormwater discharges to surface waters or drainage systems.			
Erosion Controls			
Wind erosion controls are effectively implemented			
Effective soil cover is provided for disturbed areas inactive (i.e., not scheduled to be disturbed for 14 days) as well as finished slopes, open space, utility backfill, and completed lots			
The use of plastic materials is limited in cases when a more sustainable, environmentally friendly alternative exists.			
Sediment Controls			
Perimeter controls are established and effective at controlling erosion and sediment discharges from the site			
Entrances and exits are stabilized to control erosion and sediment discharges from the site			
Sediment basins are properly maintained			
Linear sediment control along toe of slope, face of slope and at grade breaks (Risk Level 2 & 3 Only)			
Limit construction activity to and from site to entrances and exits that employ effective controls to prevent offsite tracking (Risk Level 2 & 3 Only)			

Ensure all storm, drain inlets and perimeter controls, runoff control BMPs and pollutants controls at entrances and exits are maintained and protected from activities the reduce their effectiveness (Risk Level 2 & 3 Only)			
Inspect all immediate access roads daily (Risk Level 2 & 3 Only)			
Run-On and Run-Off Controls			
Run-on to the site is effectively managed and directed away from all disturbed areas.			
Other			
Are the project SWPPP and BMP plan up to date, available on-site and being properly implemented?			

Part III. Descriptions of BMP Deficiencies		
Deficiency	Repairs Implemented: Note - Repairs must begin within 72 hours of identification and, complete repairs as soon as possible.	
	Start Date	Action
1.		
2.		
3.		
4.		

Part IV. Additional Pre-Storm Observations. Note the presence or absence of floating and suspended materials, sheen, discoloration, turbidity, odors, and source(s) of pollutants(s).	
	Yes, No, N/A
Do stormwater storage and containment areas have adequate freeboard? If no, complete Part III.	
Are drainage areas free of spills, leaks, or uncontrolled pollutant sources? If no, complete Part VII and describe below.	
Notes:	
Are stormwater storage and containment areas free of leaks? If no, complete Parts III and/or VII and describe below.	

Notes:

--	--

Part V. Additional During Storm Observations. If BMPs cannot be inspected during inclement weather, list the results of visual inspections at all relevant outfalls, discharge points, and downstream locations. Note odors or visible sheen on the surface of discharges. Complete Part VII (Corrective Actions) as needed.

Outfall, Discharge Point, or Other Downstream Location	
Location	Description
Location	Description
Location	Description
Location	Description
Location	Description
Location	Description
Location	Description
Location	Description

Part VI. Additional Post-Storm Observations. Visually observe (inspect) stormwater discharges at all discharge locations within two business days (48 hours) after each qualifying rain event, and observe (inspect) the discharge of stored or contained stormwater that is derived from and discharged subsequent to a qualifying rain event producing precipitation of ½ inch or more at the time of discharge. Complete Part VII (Corrective Actions) as needed.

Discharge Location, Storage or Containment Area	Visual Observation

Part VII. Additional Corrective Actions Required. Identify additional corrective actions not included with BMP Deficiencies (Part III) above. Note if SWPPP change is required.

Required Actions	Implementation Date

***Appendix J: Project Specific Rain Event Action Plan
Template***

Rain Event Action Plan (REAP)

Date of REAP		WDID Number:	
Date Rain Predicted to Occur:		Predicted % chance of rain:	

Predicted Rain Event Triggered Actions

Below is a list of suggested actions and items to review for this project. Each active Trade should check all material storage areas, stockpiles, waste management areas, vehicle and equipment storage and maintenance, areas of active soil disturbance, and areas of active work to ensure the proper implementation of BMPs. Project-wide BMPs should be checked and cross-referenced to the BMP progress map.

Trade or Activity	Suggested action(s) to perform / item(s) to review prior to rain event
• Information & Scheduling	<ul style="list-style-type: none"> • Inform trade supervisors of predicted rain • Check scheduled activities and reschedule as needed • Alert erosion/sediment control provider • Alert sample collection contractor (if applicable) • Schedule staff for extended rain inspections • Check Erosion and Sediment Control (ESC) material stock • Review BMP progress map • Other: _____ • _____ • _____
• Material storage areas	<ul style="list-style-type: none"> • Material under cover or in sheds (ex: treated woods and metals) • Perimeter control around stockpiles • Other: _____ • _____ • _____
• Waste management areas	<ul style="list-style-type: none"> • Dumpsters closed • Drain holes plugged • Recycling bins covered • Sanitary stations bermed and protected from tipping • Other: _____ • _____ • _____
• Trade operations	<ul style="list-style-type: none"> • Exterior operations shut down for event (e.g., no concrete pours or paving) • Soil treatments (e.g., fertilizer) ceased within 24 hours of event • Materials and equipment (e.g., tools) properly stored and covered • Waste and debris disposed in covered dumpsters or removed from site • Trenches and excavations protected • Perimeter controls around disturbed areas • Fueling and repair areas covered and bermed • Other: _____ • _____ • _____
• Site ESC BMPs	<ul style="list-style-type: none"> • Adequate capacity in sediment basins and traps • Site perimeter controls in place • Catch basin and drop inlet protection in place and cleaned • Temporary erosion controls deployed • Temporary perimeter controls deployed around disturbed areas and stockpiles • Roads swept; site ingress and egress points stabilized • Other: _____ • _____ • _____
• Concrete rinse out area	<ul style="list-style-type: none"> • Adequate capacity for rain • Wash-out bins covered • Other: _____ • _____ • _____
• Spill and drips	<ul style="list-style-type: none"> <input type="checkbox"/> All incident spills and drips, including paint, stucco, fuel, and oil cleaned <input type="checkbox"/> Drip pans emptied • Other: _____ <input type="checkbox"/> _____ <input type="checkbox"/> _____

Continued on next page.

• Other / Discussion /
Diagrams

<input type="checkbox"/>	_____
<input type="checkbox"/>	_____
<input type="checkbox"/>	_____
<input type="checkbox"/>	_____
<input type="checkbox"/>	_____
<input type="checkbox"/>	_____
<input type="checkbox"/>	_____
<input type="checkbox"/>	_____
<input type="checkbox"/>	_____
<input type="checkbox"/>	_____
<input type="checkbox"/>	_____
<input type="checkbox"/>	_____
<input type="checkbox"/>	_____
<input type="checkbox"/>	_____
<input type="checkbox"/>	_____
<input type="checkbox"/>	_____

Attach a printout of the weather forecast from the NOAA website to the REAP.

I certify under penalty of law that this Rain Event Action Plan (REAP) will be performed in accordance with the General Permit by me or under my direction or supervision in accordance with a system designed to assure that qualified personnel properly gathered and evaluated the information submitted. Based on my inquiry of the persons who manage the system, or those persons directly responsible for gathering the information, the information submitted is, to the best of my knowledge and belief, true, accurate, and complete. I am aware that there are significant penalties for submitting false information, including the possibility of fine and imprisonment for knowing violations.

Date: _____

Qualified SWPPP Practitioner (Use ink please)

Appendix K: Training Reporting Form

Trained Contractor Personnel Log

Stormwater Management Training Log and Documentation

Project Name:
DONNER PASS ROAD IMPROVEMENTS (CA FLAP NEV 40(1))

WDID #: _____

Stormwater Management Topic: (check as appropriate)

- | | |
|--|---|
| <input type="checkbox"/> Erosion Control | <input type="checkbox"/> Sediment Control |
| <input type="checkbox"/> Wind Erosion Control | <input type="checkbox"/> Tracking Control |
| <input type="checkbox"/> Non-Stormwater Management | <input type="checkbox"/> Waste Management and Materials Pollution Control |
| <input type="checkbox"/> Stormwater Sampling | |

Specific Training Objective: _____

Location: _____

Date: _____

Instructor: _____

Telephone: _____

Course Length (hours): _____

Attendee Roster (Attach additional forms if necessary)

Name	Company	Phone

As needed, add proof of external training (e.g., course completion certificates, credentials for QSP, QSD).



BOARD FOR PROFESSIONAL ENGINEERS AND LAND SURVEYORS



This Is To Certify That Pursuant
To The Provisions of Chapter 7, Division 3 of The Business and Professions Code

Mohammad Arhami

IS DULY LICENSED AS A
PROFESSIONAL ENGINEER
IN
CIVIL ENGINEERING

In The State of California, and Is Entitled To All The Rights and
Privileges Conferred In Said Code

WITNESS OUR HAND AND SEAL

Certificate No C 72853

This 14th day of March, 2008, at Sacramento, California

BOARD FOR PROFESSIONAL
ENGINEERS AND LAND SURVEYORS



Executive Officer

President

Search
Business
First Nam
arhami

ABOUT 2800 RESULTS (SHOWING 20)



ARHAMI, MOHAMMAD

LICENSE NUMBER: [72853](#) LICENSE TYPE: CIVIL ENGINEER

LICENSE STATUS: CLEAR EXPIRATION DATE: JUNE 30, 2022

SECONDARY STATUS: N/A

CITY: LOS ANGELES STATE: CALIFORNIA COUNTY: LOS ANGELES ZIP: 90036

Water Boards Storm Water Multiple Application & Report Tracking System

You are logged-in as: **Mohammad Arhami** - .
If this account does not belong to you, please log out.

CBPELSG - QSD

Please enter information below to search

Please enter information

Last Name:	<input type="text" value="Arhami"/>
First Name:	<input type="text"/>

<input type="button" value="Search for Existing Records"/>	<input type="button" value="Create New Record"/>
--	--

First Name	Last Name	Address	CBPELSG License No.	QSD Certificate No.
Mohammad	Arhami	400 S BURNSIDE AVE APT #4G Los Angeles CA 90036	72853	C72853

CERTIFICATE OF TRAINING

CALIFORNIA CONSTRUCTION GENERAL PERMIT

QUALIFIED SWPPP PRACTITIONER (QSP)

Mohammad Arhami

Sep 20, 2020 - Nov 20, 2022

Certificate # 26962



California Stormwater Quality Association and
California Construction General Permit Training Team

CERTIFICATE OF TRAINING

THIS CERTIFICATE ACKNOWLEDGES ATTENDANCE BY

Mohammad Arhami

8-HOUR WATER POLLUTION CONTROL MANAGER
TRAINING COURSE PER 13-1.01D(4)(b)
NOVEMBER 11, 2020



A handwritten signature in black ink that reads 'John Gleason'.

John Gleason, PE, QSD, ToR, CPESC
John.Gleason@MSHatch.com
(949) 981-3867

11-11-2020

DATE

CERTIFICATE OF TRAINING

CALIFORNIA CONSTRUCTION GENERAL PERMIT

QUALIFIED SWPPP PRACTITIONER (QSP)

Greg Herback

Jan 16, 2020 - Apr 15, 2022

Certificate # 22820



California Stormwater Quality Association and
California Construction General Permit Training Team

Appendix L: Responsible Parties

WDID No.:

Name of Project: DONNER PASS ROAD IMPROVEMENTS (CA FLAP NEV 40(1)),

Location: Donner Pass Road, Nevada County

Estimated Start Date: 05/25/2020

Estimated Completion Date: 08/31/2023

Contractor:

Herback General Engineering
2531 Nowlin Road, Minden, Nevada 89423
Phone: (775) 267-6800

QSD:

Zila
Mohammad Arhami, PhD, PE, QSD C72853
10880 Wilshire Blvd, Suite 1101, Los Angeles, CA 90024
Phone: 323-455-5012

QSP:

Herback General Engineering
Greg Herback, QSP
2531 Nowlin Road, Minden, NV 89423
Phone: 775-690-8941

LRP:

Federal Highway Administration
Central Federal Lands Highway Division
12300 West Dakota Avenue
Lakewood, CO 80228

Approved Signatory

Matt Ambroziak

Authorization of Approved Signatories

Project Name:

DONNER PASS ROAD IMPROVEMENTS (CA FLAP NEV 40(1))

WDID #: _____

Name of Personnel	Project Role	Company	Signature	Date

LRP's Signature

Date

LRP Name and Title

Telephone Number

Identification of QSP

Project Name:

DONNER PASS ROAD IMPROVEMENTS (CA FLAP NEV 40(1))

WDID #: _____

The following are QSPs associated with this project

Name of Personnel ⁽¹⁾	Company	Date
Greg Herback	QSP	

(1) If additional QSPs are required on the job site add additional lines and include information here

Authorization of Data Submitters

Project Name:

DONNER PASS ROAD IMPROVEMENTS (CA FLAP NEV 40(1))

WDID #: _____

Name of Personnel	Project Role	Company	Signature	Date

Approved Signatory's Signature

Date

Approved Signatory
Name and Title

Telephone Number

Appendix M: Contractors and Subcontractors

SUBCONTRACTORS:

- **Statewide Traffic Safety & Signs**
- **Osborn General Engineering & Construction**
- **Green Vista Landscape**
- **A.C. Dike Co.**
- **Neil's Controlled Blasting, L.P.**
- **Apply-A-Line, LLC**
- **Tyrrell Resources, LLC**
- **Dirt & Aggregate Interchange, Inc.**

Appendix N: Construction General Permit



Linda S. Adams
Secretary for
Environmental Protection

State Water Resources Control Board
Division of Water Quality

1001 I Street • Sacramento, California 95814 • (916) 341-5455
Mailing Address: P.O. Box 100 • Sacramento, California • 95812-0100
Fax (916) 341-5463 • <http://www.waterboards.ca.gov>



Arnold Schwarzenegger
Governor

CONSTRUCTION GENERAL PERMIT FACT SHEET TABLE OF CONTENTS

I. BACKGROUND 1

A. History 1

B. Legal Challenges and Court Decisions..... 1

C. Blue Ribbon Panel of Experts and Feasibility of Numeric Effluent Limitations 4

D. Summary of Panel Findings on Construction Activities 4

E. How the Panel’s Findings are Used in this General Permit 5

F. Summary of Significant Changes in This General Permit 5

II. RATIONALE 7

A. General Permit Approach..... 7

B. Construction Activities Covered..... 7

C. Construction Activities Not Covered 9

D. Obtaining and Terminating Permit Coverage 12

E. Discharge Prohibitions 12

F. Effluent Standards for All Types of Discharges..... 13

G. Receiving Water Limitations 20

H. Training Qualifications and Requirements 20

I. Sampling, Monitoring, Reporting and Record Keeping..... 21

J. Risk Determination..... 27

K. ATS Requirements..... 35

L. Post-Construction Requirements 37

M. Storm Water Pollution Prevention Plans 46

N. Regional Water Board Authorities..... 48

LIST OF TABLES

Table 1 - Regional Water Board Basin Plans, Water Quality Objectives for Turbidity	16
Table 2 - Results of Ecoregion Analysis	16
Table 3 – ACL Sampling Data taken by Regional Water Board Staff	17
Table 4 - Required Monitoring Elements for Risk Levels	21
Table 5 - Storm Water Effluent Monitoring Requirements by Risk Level	23
Table 6 - Receiving Water Monitoring Requirements	26
Table 7 - Combined Risk Level Matrix	29
Table 8 -National Oceanic and Atmospheric Administration (NOAA) Definition of Probability of Precipitation (PoP)	31
Table 9 - Qualified SWPPP Developer/ Qualified SWPPP Practitioner Certification Criteria	47

LIST OF FIGURES

Figure 1 -Statewide Map of K * LS	28
Figure 2 - Suite of Storm Events	37
Figure 3 - Northern CA (2009) Counties / Cities With SUSMP-Plus Coverage	39
Figure 4 - Southern CA (2009) Counties / Cities With SUSMP-Plus Coverage	40
Figure 5 - Schematic of the Lane Relationship	42
Figure 6 - Channel Changes Associated with Urbanization	43

I. BACKGROUND

A. History

In 1972, the Federal Water Pollution Control Act (also referred to as the Clean Water Act [CWA]) was amended to provide that the discharge of pollutants to waters of the United States from any point source is unlawful unless the discharge is in compliance with a National Pollutant Discharge Elimination System (NPDES) permit. The 1987 amendments to the CWA added Section 402(p), which establishes a framework for regulating municipal and industrial storm water discharges under the NPDES Program. On November 16, 1990, the U.S. Environmental Protection Agency (USEPA) published final regulations that established storm water permit application requirements for specified categories of industries. The regulations provide that discharges of storm water to waters of the United States from construction projects that encompass five or more acres of soil disturbance are effectively prohibited unless the discharge is in compliance with an NPDES Permit. Regulations (Phase II Rule) that became final on December 8, 1999 lowered the permitting threshold from five acres to one acre.

While federal regulations allow two permitting options for storm water discharges (Individual Permits and General Permits), the State Water Board has elected to adopt only one statewide General Permit at this time that will apply to most storm water discharges associated with construction activity.

On August 19, 1999, the State Water Board reissued the General Construction Storm Water Permit (Water Quality Order 99-08-DWQ). On December 8, 1999 the State Water Board amended Order 99-08-DWQ to apply to sites as small as one acre.

The General Permit accompanying this fact sheet regulates storm water runoff from construction sites. Regulating many storm water discharges under one permit will greatly reduce the administrative burden associated with permitting individual storm water discharges. To obtain coverage under this General Permit, dischargers shall electronically file the Permit Registration Documents (PRDs), which includes a Notice of Intent (NOI), Storm Water Pollution Prevention Plan (SWPPP), and other compliance related documents required by this General Permit and mail the appropriate permit fee to the State Water Board. It is expected that as the storm water program develops, the Regional Water Quality Control Boards (Regional Water Boards) may issue General Permits or Individual Permits containing more specific permit provisions. When this occurs, this General Permit will no longer regulate those dischargers.

B. Legal Challenges and Court Decisions

1. Early Court Decisions

Shortly after the passage of the CWA, the USEPA promulgated regulations exempting most storm water discharges from the NPDES permit requirements. (See 40 C.F.R. § 125.4 (1975); see also *Natural Resources Defense Council v. Costle* (D.C. Cir. 1977) 568 F.2d 1369, 1372 (*Costle*); *Defenders of Wildlife v. Browner* (9th Cir. 1999) 191 F.3d 1159, 1163 (*Defenders of Wildlife*)). When environmental groups challenged this exemption in federal court, the District of Columbia Court of Appeals invalidated the regulation, holding that the USEPA “does not have authority to exempt categories of point sources from the permit requirements of [CWA] § 402.” (*Costle*, 568 F.2d at 1377.) The *Costle* court rejected the USEPA’s argument that effluent-based storm sewer regulation was administratively infeasible because of the variable nature of storm water pollution and the number of affected storm sewers throughout the country. (*Id.* at 1377-82.) Although the court acknowledged the practical problems relating to storm sewer regulation, the court found the USEPA had the flexibility under the CWA to design regulations that would overcome these problems. (*Id.* at 1379-83.) In particular, the court pointed to general permits and permits based on requiring best management practices (BMPs).

During the next 15 years, the USEPA made numerous attempts to reconcile the statutory requirement of point source regulation with the practical problem of regulating possibly millions of diverse point source discharges of storm water. (See *Defenders of Wildlife*, 191 F.3d at 1163; see also Gallagher, Clean Water Act in Environmental Law Handbook (Sullivan, edit., 2003) p. 300 (Environmental Law Handbook); Eisen, *Toward a Sustainable Urbanism: Lessons from Federal Regulation of Urban Storm Water Runoff* (1995) 48 Wash. U.J. Urb. & Contemp. L.1, 40-41 [Regulation of Urban Storm Water Runoff].)

In 1987, Congress amended the CWA to require NPDES permits for storm water discharges. (See CWA § 402(p), 33 U.S.C. § 1342(p); *Defenders of Wildlife*, 191 F.3d at 1163; *Natural Resources Defense Council v. USEPA* (9th Cir. 1992) 966 F.2d 1292, 1296.) In these amendments, enacted as part of the Water Quality Act of 1987, Congress distinguished between industrial and municipal storm water discharges. With respect to industrial storm water discharges, Congress provided that NPDES permits "shall meet all applicable provisions of this section and section 1311 [requiring the USEPA to establish effluent limitations under specific timetables]." (CWA § 402(p)(3)(A), 33 U.S.C. § 1342(p)(3)(A); see also *Defenders of Wildlife*, 191 F.3d at 1163-64.)

In 1990, USEPA adopted regulations specifying what activities were considered "industrial" and thus required discharges of storm water associated with those activities to obtain coverage under NPDES permits. (55 Fed. Reg. 47,990 (1990); 40 C.F.R. § 122.26(b)(14).) Construction activities, deemed a subset of the industrial activities category, must also be regulated by an NPDES permit. (40 C.F.R. § 122.26(b)(14)(x)). In 1999, USEPA issued regulations for "Phase II" of storm water regulation, which required most small construction sites (1-5 acres) to be regulated under the NPDES program. (64 Fed. Reg. 68,722; 40 C.F.R. § 122.26(b)(15)(i).)

2. Court Decisions on Public Participation

Two recent federal court opinions have vacated USEPA rules that denied meaningful public review of NPDES permit conditions. On January 14, 2003, the Ninth Circuit Court of Appeals held that certain aspects of USEPA's Phase II regulations governing MS4s were invalid primarily because the general permit did not contain express requirements for public participation. (*Environmental Defense Center v. USEPA* (9th Cir. 2003) 344 F.3d 832.) Specifically, the court determined that applications for general permit coverage (including the Notice of Intent (NOI) and Storm Water Management Program (SWMP)) must be made available to the public, the applications must be reviewed and determined to meet the applicable standard by the permitting authority before coverage commences, and there must be a process to accommodate public hearings. (*Id.* at 852-54.) Similarly, on February 28, 2005, the Second Circuit Court of Appeals held that the USEPA's confined animal feeding operation (CAFO) rule violated the CWA because it allowed dischargers to write their own nutrient management plans without public review. (*Waterkeeper Alliance v. USEPA* (2d Cir. 2005) 399 F.3d 486.) Although neither decision involved the issuance of construction storm water permits, the State Water Board's Office of Chief Counsel has recommended that the new General Permit address the courts' rulings where feasible¹.

¹ In *Texas Independent Producers and Royalty Owners Assn. v. USEPA* (7th Cir. 2005) 410 F.3d 964, the Seventh Circuit Court of Appeals held that the USEPA's construction general permit was not required to provide the public with the opportunity for a public hearing on the Notice of Intent or Storm Water Pollution Prevention Plan. The Seventh Circuit briefly discussed why it agreed with the Ninth Circuit's dissent in *Environmental Defense Center*, but

The CWA and the USEPA's regulations provide states with the discretion to formulate permit terms, including specifying best management practices (BMPs), to achieve strict compliance with federal technology-based and water quality-based standards. (*Natural Resources Defense Council v. USEPA* (9th Cir. 1992) 966 F.2d 1292, 1308.) Accordingly, this General Permit has developed specific BMPs as well as numeric action levels (NALs) in order to achieve these minimum federal standards. In addition, the General Permit requires a SWPPP and REAP (another dynamic, site-specific plan) to be developed but has removed all language requiring the discharger to implement these plans – instead, the discharger is required to comply with specific requirements. By requiring the dischargers to implement these specific BMPs and NALs, this General Permit ensures that the dischargers do not “write their own permits.” As a result this General Permit does not require each discharger's SWPPP and REAP to be reviewed and approved by the Regional Water Boards.

This General Permit also requires dischargers to electronically file all permit-related compliance documents. These documents include, but are not limited to, NOIs, SWPPPs, annual reports, Notice of Terminations (NOTs), and numeric action level (NAL) exceedance reports. Electronically submitted compliance information is immediately available to the public, as well as the Regional Water Quality Control Board (Regional Water Board) offices, via the Internet. In addition, this General Permit enables public review and hearings on permit applications when appropriate. Under this General Permit, the public clearly has a meaningful opportunity to participate in the permitting process.

generally did not discuss the substantive holdings in *Environmental Defense Center and Waterkeeper Alliance*, because neither court addressed the initial question of whether the plaintiffs had standing to challenge the permits at issue. However, notwithstanding the Seventh Circuit's decision, it is not binding or controlling on the State Water Board because California is located within the Ninth Circuit.

C. Blue Ribbon Panel of Experts and Feasibility of Numeric Effluent Limitations

In 2005 and 2006, the State Water Board convened an expert panel (panel) to address the feasibility of numeric effluent limitations (NELs) in California's storm water permits. Specifically, the panel was asked to address:

"Is it technically feasible to establish numeric effluent limitations, or some other quantifiable limit, for inclusion in storm water permits? How would such limitations or criteria be established, and what information and data would be required?"

"The answers should address industrial general permits, construction general permits, and area-wide municipal permits. The answers should also address both technology-based limitations or criteria and water quality-based limitations or criteria. In evaluating establishment of any objective criteria, the panel should address all of the following:

The ability of the State Water Board to establish appropriate objective limitations or criteria;

How compliance determinations would be made;

The ability of dischargers and inspectors to monitor for compliance; and

The technical and financial ability of dischargers to comply with the limitations or criteria."

Through a series of public participation processes (State Water Board meetings, State Water Board workshops, and the solicitation of written comments), a number of water quality, public process and overall program effectiveness problems were identified. Some of these problems are addressed through this General Permit.

D. Summary of Panel Findings on Construction Activities

The panel's final report can be downloaded and viewed through links at www.waterboards.ca.gov or by clicking [here](#)².

The panel made the following observations:

"Limited field studies indicate that traditional erosion and sediment controls are highly variable in performance, resulting in highly variable turbidity levels in the site discharge."

"Site-to-site variability in runoff turbidity from undeveloped sites can also be quite large in many areas of California, particularly in more arid regions with less natural vegetative cover and steep slopes."

² http://www.waterboards.ca.gov/stormwtr/docs/numeric/swpanel_final_report.pdf

“Active treatment technologies involving the use of polymers with relatively large storage systems now exist that can provide much more consistent and very low discharge turbidity. However, these technologies have as yet only been applied to larger construction sites, generally five acres or greater. Furthermore, toxicity has been observed at some locations, although at the vast majority of sites, toxicity has not occurred. There is also the potential for an accidental large release of such chemicals with their use.”

“To date most of the construction permits have focused on TSS and turbidity, but have not addressed other, potentially significant pollutants such as phosphorus and an assortment of chemicals used at construction sites.”

“Currently, there is no required training or certification program for contractors, preparers of soil erosion and sediment control Storm Water Pollution Prevention Plans, or field inspectors.”

“The quality of storm water discharges from construction sites that effectively employ BMPs likely varies due to site conditions such as climate, soil, and topography.”

“The States of Oregon and Washington have recently adopted similar concepts to the Action Levels described earlier.”

In addition, the panel made the following conclusions:

“It is the consensus of the Panel that active treatment technologies make Numeric Limits technically feasible for pollutants commonly associated with storm water discharges from construction sites (e.g. TSS and turbidity) for larger construction sites. Technical practicalities and cost-effectiveness may make these technologies less feasible for smaller sites, including small drainages within a larger site, as these technologies have seen limited use at small construction sites. If chemical addition is not permitted, then Numeric Limits are not likely feasible.”

“The Board should consider Numeric Limits or Action Levels for other pollutants of relevance to construction sites, but in particular pH. It is of particular concern where fresh concrete or wash water from cement mixers/equipment is exposed to storm water.”

“The Board should consider the phased implementation of Numeric Limits and Action Levels, commensurate with the capacity of the dischargers and support industry to respond.”

E. How the Panel’s Findings are Used in this General Permit

The State Water Board carefully considered the findings of the panel and related public comments. The State Water Board also reviewed and considered the comments regarding statewide storm water policy and the reissuance of the Industrial General Permit. From the input received the State Water Board identified some permit and program performance gaps that are addressed in this General Permit. The Summary of Significant Changes (below) in this General Permit are a direct result of this process.

F. Summary of Significant Changes in This General Permit

The State Water Board has significant changes to Order 99-08-DWQ. This General Permit differs from Order 99-08-DWQ in the following significant ways:

Rainfall Erosivity Waiver: this General Permit includes the option allowing a small construction site (>1 and <5 acres) to self-certify if the rainfall erosivity value (R value) for their site's given location and time frame compute to be less than or equal to 5.

Technology-Based Numeric Action Levels: this General Permit includes NALs for pH and turbidity.

Risk-Based Permitting Approach: this General Permit establishes three levels of risk possible for a construction site. Risk is calculated in two parts: 1) Project Sediment Risk, and 2) Receiving Water Risk.

Minimum Requirements Specified: this General Permit imposes more minimum BMPs and requirements that were previously only required as elements of the SWPPP or were suggested by guidance.

Project Site Soil Characteristics Monitoring and Reporting: this General Permit provides the option for dischargers to monitor and report the soil characteristics at their project location. The primary purpose of this requirement is to provide better risk determination and eventually better program evaluation.

Effluent Monitoring and Reporting: this General Permit requires effluent monitoring and reporting for pH and turbidity in storm water discharges. The purpose of this monitoring is to evaluate whether NALs and NELs for Active Treatment Systems included in this General Permit are exceeded.

Receiving Water Monitoring and Reporting: this General Permit requires some Risk Level 3 and LUP Type 3 dischargers to monitor receiving waters and conduct bioassessments.

Post-Construction Storm Water Performance Standards: this General Permit specifies runoff reduction requirements for all sites not covered by a Phase I or Phase II MS4 NPDES permit, to avoid, minimize and/or mitigate post-construction storm water runoff impacts.

Rain Event Action Plan: this General Permit requires certain sites to develop and implement a Rain Event Action Plan (REAP) that must be designed to protect all exposed portions of the site within 48 hours prior to any likely precipitation event.

Annual Reporting: this General Permit requires all projects that are enrolled for more than one continuous three-month period to submit information and annually certify that their site is in compliance with these requirements. The primary purpose of this requirement is to provide information needed for overall program evaluation and public information.

Certification/Training Requirements for Key Project Personnel: this General Permit requires that key personnel (e.g., SWPPP preparers, inspectors, etc.) have specific training or certifications to ensure their level of knowledge and skills are adequate to ensure their ability to design and evaluate project specifications that will comply with General Permit requirements.

Linear Underground/Overhead Projects: this General Permit includes requirements for all Linear Underground/Overhead Projects (LUPs).

II. RATIONALE

A. General Permit Approach

A general permit for construction activities is an appropriate permitting approach for the following reasons:

1. A general permit is an efficient method to establish the essential regulatory requirements for a broad range of construction activities under differing site conditions;
2. A general permit is the most efficient method to handle the large number of construction storm water permit applications;
3. The application process for coverage under a general permit is far less onerous than that for individual permit and hence more cost effective;
4. A general permit is consistent with USEPA's four-tier permitting strategy, the purpose of which is to use the flexibility provided by the CWA in designing a workable and efficient permitting system; and
5. A general permit is designed to provide coverage for a group of related facilities or operations of a specific industry type or group of industries. It is appropriate when the discharge characteristics are sufficiently similar, and a standard set of permit requirements can effectively provide environmental protection and comply with water quality standards for discharges. In most cases, the general permit will provide sufficient and appropriate management requirements to protect the quality of receiving waters from discharges of storm water from construction sites.

There may be instances where a general permit is not appropriate for a specific construction project. A Regional Water Board may require any discharger otherwise covered under the General Permit to apply for and obtain an Individual Permit or apply for coverage under a more specific General Permit. The Regional Water Board must determine that this General Permit does not provide adequate assurance that water quality will be protected, or that there is a site-specific reason why an individual permit should be required.

B. Construction Activities Covered

1. Construction activity subject to this General Permit:

Any construction or demolition activity, including, but not limited to, clearing, grading, grubbing, or excavation, or any other activity that results in a land disturbance of equal to or greater than one acre.

Construction activity that results in land surface disturbances of less than one acre if the construction activity is part of a larger common plan of development or sale of one or more acres of disturbed land surface.

Construction activity related to residential, commercial, or industrial development on lands currently used for agriculture including, but not limited to, the construction of buildings related to agriculture that are considered industrial pursuant to USEPA regulations, such as dairy barns or food processing facilities.

Construction activity associated with LUPs including, but not limited to, those activities necessary for the installation of underground and overhead linear facilities (e.g., conduits, substructures, pipelines, towers, poles, cables, wires, connectors, switching, regulating and transforming equipment and associated ancillary facilities) and include, but are not limited to, underground utility mark-out, potholing, concrete

and asphalt cutting and removal, trenching, excavation, boring and drilling, access road and pole/tower pad and cable/wire pull station, substation construction, substructure installation, construction of tower footings and/or foundations, pole and tower installations, pipeline installations, welding, concrete and/or pavement repair or replacement, and stockpile/borrow locations.

Discharges of sediment from construction activities associated with oil and gas exploration, production, processing, or treatment operations or transmission facilities.³

Storm water discharges from dredge spoil placement that occur outside of U.S. Army Corps of Engineers jurisdiction⁴ (upland sites) and that disturb one or more acres of land surface from construction activity are covered by this General Permit. Construction projects that intend to disturb one or more acres of land within the jurisdictional boundaries of a CWA § 404 permit should contact the appropriate Regional Water Board to determine whether this permit applies to the project.

2. Linear Underground/Overhead Projects (LUPs) subject to this General Permit:

Underground/overhead facilities typically constructed as LUPs include, but are not limited to, any conveyance, pipe, or pipeline for the transportation of any gaseous, liquid (including water, wastewater for domestic municipal services), liquescent, or slurry substance; any cable line or wire for the transmission of electrical energy; any cable line or wire for communications (e.g., telephone, telegraph, radio or television messages); and associated ancillary facilities. Construction activities associated with LUPs include, but are not limited to, those activities necessary for the installation of underground and overhead linear facilities (e.g., conduits, substructures, pipelines, towers, poles, cables, wires, connectors, switching, regulating and transforming equipment and associated ancillary facilities) and include, but are not limited to, underground utility mark-out, potholing, concrete and asphalt cutting and removal, trenching, excavation, boring and drilling, access road and pole/tower pad and cable/wire pull station, substation construction, substructure installation, construction of tower footings and/or foundations, pole and tower installations, pipeline installations, welding, concrete and/or pavement repair or replacement, and stockpile/borrow locations.

Water Quality Order 2003-0007-DWQ regulated construction activities associated with small LUPs that resulted in land disturbances greater than one acre, but less than five acres. These projects were considered non-traditional construction projects. Attachment A of this Order now regulates all construction activities from LUPs resulting in land disturbances greater than one acre.

3. Common Plan of Development or Sale

USEPA regulations include the term “common plan of development or sale” to ensure that acreage within a common project does not artificially escape the permit requirements because construction activities are phased, split among smaller parcels, or completed by different owners/developers. In the absence of an

³ Pursuant to the Ninth Circuit Court of Appeals' decision in *NRDC v. EPA* (9th Cir. 2008) 526 F.3d 591, and subsequent denial of the USEPA's petition for reconsideration in November 2008, oil and gas construction activities discharging storm water contaminated only with sediment are no longer exempt from the NPDES program.

⁴ A construction site that includes a dredge and/or fill discharge to any water of the United States (e.g., wetland, channel, pond, or marine water) requires a CWA Section 404 permit from the U.S. Army Corps of Engineers and a CWA Section 401 Water Quality Certification from the Regional Water Board or State Water Board.

exact definition of “common plan of development or sale,” the State Water Board is required to exercise its regulatory discretion in providing a common sense interpretation of the term as it applies to construction projects and permit coverage. An overbroad interpretation of the term would render meaningless the clear “one acre” federal permitting threshold and would potentially trigger permitting of almost any construction activity that occurs within an area that had previously received area-wide utility or road improvements.

Construction projects generally receive grading and/or building permits (Local Permits) from local authorities prior to initiating construction activity. These Local Permits spell out the scope of the project, the parcels involved, the type of construction approved, etc. Referring to the Local Permit helps define “common plan of development or sale.” In cases such as tract home development, a Local Permit will include all phases of the construction project including rough grading, utility and road installation, and vertical construction. All construction activities approved in the Local Permit are part of the common plan and must remain under the General Permit until construction is completed. For custom home construction, Local Permits typically only approve vertical construction as the rough grading, utilities, and road improvements were already independently completed under the a previous Local Permit. In the case of a custom home site, the homeowner must submit plans and obtain a distinct and separate Local Permit from the local authority in order to proceed. It is not the intent of the State Water Board to require permitting for an individual homeowner building a custom home on a private lot of less than one acre if it is subject to a separate Local Permit. Similarly, the installation of a swimming pool, deck, or landscaping that disturbs less than one acre that was not part of any previous Local Permit are not required to be permitted.

The following are several examples of construction activity of less than one acre that would require permit coverage:

- a. A landowner receives a building permit(s) to build tract homes on a 100-acre site split into 200 one-third acre parcels, (the remaining acreage consists of streets and parkways) which are sold to individual homeowners as they are completed. The landowner completes and sells all the parcels except for two. Although the remaining two parcels combined are less than one acre, the landowner must continue permit coverage for the two parcels.
- b. One of the parcels discussed above is sold to another owner who intends to complete the construction as already approved in the Local Permit. The new landowner must file Permit Registration Documents (PRDs) to complete the construction even if the new landowner is required to obtain a separate Local Permit.
- c. Landowner in (1) above purchases 50 additional one half-acre parcels adjacent to the original 200-acre project. The landowner seeks a Local Permit (or amendment to existing Local permit) to build on 20 parcels while leaving the remaining 30 parcels for future development. The landowner must amend PRDs to include the 20 parcels 14 days prior to commencement of construction activity on those parcels.

C. Construction Activities Not Covered

1. Traditional Construction Projects Not Covered

This General Permit does not apply to the following construction activity:

- a. Routine maintenance to maintain original line and grade, hydraulic capacity, or original purpose of the facility.

- b. Disturbances to land surfaces solely related to agricultural operations such as disking, harrowing, terracing and leveling, and soil preparation.
- c. Discharges of storm water from areas on tribal lands; construction on tribal lands is regulated by a federal permit.
- d. Discharges of storm water within the Lake Tahoe Hydrologic Unit. The Lahontan Regional Water Board has adopted its own permit to regulate storm water discharges from construction activity in the Lake Tahoe Hydrologic Unit (Regional Water Board 6SLT). Owners of construction projects in this watershed must apply for the Lahontan Regional Water Board permit rather than the statewide Construction General Permit. Construction projects within the Lahontan region must also comply with the Lahontan Region Project Guideline for Erosion Control (R6T-2005-0007 Section), which can be found at http://www.waterboards.ca.gov/lahontan/Adopted_Orders/2005/r6t_2005_0007.pdf
- e. Construction activity that disturbs less than one acre of land surface, unless part of a larger common plan of development or the sale of one or more acres of disturbed land surface.
- f. Construction activity covered by an individual NPDES Permit for storm water discharges.
- g. Landfill construction activity that is subject to the Industrial General Permit.
- h. Construction activity that discharges to Combined Sewer Systems.
- i. Conveyances that discharge storm water runoff combined with municipal sewage.
- j. Discharges of storm water identified in CWA § 402(l)(2), 33 U.S.C. § 1342(l)(2).

2. Linear Projects Not Covered

- a. LUP construction activity does not include linear routine maintenance projects. Routine maintenance projects are projects associated with operations and maintenance activities that are conducted on existing lines and facilities and within existing right-of-way, easements, franchise agreements, or other legally binding agreements of the discharger. Routine maintenance projects include, but are not limited to projects that are conducted to:
 - i. Maintain the original purpose of the facility or hydraulic capacity.
 - ii. Update existing lines⁵ and facilities to comply with applicable codes, standards, and regulations regardless if such projects result in increased capacity.
 - iii. Repairing leaks.

⁵Update existing lines includes replacing existing lines with new materials or pipes.

Routine maintenance does not include construction of new⁶ lines or facilities resulting from compliance with applicable codes, standards, and regulations.

Routine maintenance projects do not include those areas of maintenance projects that are outside of an existing right-of-way, franchise, easements, or agreements. When a project must secure new areas, those areas may be subject to this General Permit based on the area of disturbed land outside the original right-of-way, easement, or agreement.

- b. LUP construction activity does not include field activities associated with the planning and design of a project (e.g., activities associated with route selection).
- c. Tie-ins conducted immediately adjacent to “energized” or “pressurized” facilities by the discharger are not considered construction activities where all other LUP construction activities associated with the tie-in are covered by an NOI and SWPPP of a third party or municipal agency.

3. EPA’s Small Construction Rainfall Erosivity Waiver

EPA’s Storm Water Phase II Final Rule provides the option for a Small Construction Rainfall Erosivity Waiver. This waiver applies to small construction sites between 1 and 5 acres, and allows permitting authorities to waive those sites that do not have adverse water quality impacts.

Dischargers eligible for this waiver are exempt from Construction General Permit Coverage. In order to obtain the waiver, the discharger must certify to the State Water Board that small construction activity will occur only when the rainfall erosivity factor is less than 5 (“R” in the Revised Universal Soil Loss Equation). The period of construction activity begins at initial earth disturbance and ends with final stabilization. Where vegetation will be used for final stabilization, the date of installation of a practice that provides interim non-vegetative stabilization can be used for the end of the construction period. The operator must agree (as a condition waiver eligibility) to periodically inspect and properly maintain the area until the criteria for final stabilization as defined in the General Permit have been met. If use of this interim stabilization eligibility condition was relied on to qualify for the waiver, signature on the waiver with a certification statement constitutes acceptance of and commitment to complete the final stabilization process. The discharger must submit a waiver certification to the State Board prior to commencing construction activities.

USEPA funded a cooperative agreement with Texas A&M University to develop an online rainfall erosivity calculator. Dischargers can access the calculator from EPA’s website at: www.epa.gov/npdes/stormwater/cgp. Use of the calculator allows the discharger to determine potential eligibility for the rainfall erosivity waiver. It may also be useful in determining the time periods during which construction activity could be waived from permit coverage.

⁶New lines are those that are not associated with existing facilities and are not part of a project to update or replace existing lines.

D. Obtaining and Terminating Permit Coverage

The appropriate Legally Responsible Person (LRP) must obtain coverage under this General Permit. To obtain coverage, the LRP or the LRP's Approved Signatory must file Permit Registration Documents (PRDs) prior to the commencement of construction activity. Failure to obtain coverage under this General Permit for storm water discharges to waters of the United States is a violation of the CWA and the California Water Code.

To obtain coverage under this General Permit, LRPs must electronically file the PRDs, which include a Notice of Intent (NOI), Storm Water Pollution Prevention Plan (SWPPP), and other documents required by this General Permit, and mail the appropriate permit fee to the State Water Board. It is expected that as the storm water program develops, the Regional Water Boards may issue General Permits or Individual Permits that contain more specific permit provisions. When this occurs, this General Permit will no longer regulate those dischargers that obtain coverage under Individual Permits.

Any information provided to the Regional Water Board shall comply with the Homeland Security Act and any other federal law that concerns security in the United States; any information that does not comply should not be submitted.

The application requirements of the General Permit establish a mechanism to clearly identify the responsible parties, locations, and scope of operations of dischargers covered by the General Permit and to document the discharger's knowledge of the General Permit's requirements.

This General Permit provides a grandfathering exception to existing dischargers subject to Water Quality Order No. 99-08-DWQ. Construction projects covered under Water Quality Order No. 99-08-DWQ shall obtain permit coverage at Risk Level 1. LUP projects covered under Water Quality Order No. 2003-0007-DWQ shall obtain permit coverage at LUP Type 1. The Regional Water Boards have the authority to require Risk Determination to be performed on projects currently covered under Water Quality Order No. 99-08-DWQ and 2003-0007-DWQ where they deem necessary.

LRPs must file a Notice of Termination (NOT) with the Regional Water Board when construction is complete and final stabilization has been reached or ownership has been transferred. The discharger must certify that all State and local requirements have been met in accordance with this General Permit. In order for construction to be found complete, the discharger must install post-construction storm water management measures and establish a long-term maintenance plan. This requirement is intended to ensure that the post-construction conditions at the project site do not cause or contribute to direct or indirect water quality impacts (i.e., pollution and/or hydromodification) upstream and downstream. Specifically, the discharger must demonstrate compliance with the post-construction standards set forth in this General Permit (Section XIII). The discharger is responsible for all compliance issues including all annual fees until the NOT has been filed and approved by the local Regional Water Board.

E. Discharge Prohibitions

This General Permit authorizes the discharge of storm water to surface waters from construction activities that result in the disturbance of one or more acres of land, provided that the discharger satisfies all permit conditions set forth in the Order. This General Permit prohibits the discharge of pollutants other than storm water and non-storm water discharges authorized by this General Permit or another NPDES permit. This General Permit also prohibits all discharges which contain a hazardous substance in excess of reportable quantities established in 40 C.F.R. §§ 117.3 and 302.4, unless a separate NPDES Permit has been issued to regulate those discharges. In addition, this General Permit incorporates discharge prohibitions contained in water quality control plans, as implemented by the nine Regional Water Boards. Discharges to Areas of Special Biological Significance (ASBS) are prohibited unless covered by an exception that the State Water Board has approved.

Non-storm water discharges include a wide variety of sources, including improper dumping, spills, or leakage from storage tanks or transfer areas. Non-storm water discharges may contribute significant pollutant loads to receiving waters. Measures to control spills, leakage, and dumping, and to prevent illicit connections during construction must be addressed through structural as well as non-structural BMPs. The State Water Board recognizes, however, that certain non-storm water discharges may be necessary for the completion of construction projects. Authorized non-storm water discharges may include those from de-chlorinated potable water sources such as: fire hydrant flushing, irrigation of vegetative erosion control measures, pipe flushing and testing, water to control dust, uncontaminated ground water dewatering, and other discharges not subject to a separate general NPDES permit adopted by a region. Therefore this General Permit authorizes such discharges provided they meet the following conditions.

These authorized non-storm water discharges must:

1. be infeasible to eliminate;
2. comply with BMPs as described in the SWPPP;
3. filter or treat, using appropriate technology, all dewatering discharges from sedimentation basins;
4. meet the NALs for pH and turbidity; and
5. not cause or contribute to a violation of water quality standards.

Additionally, authorized non-storm water discharges must not be used to clean up failed or inadequate construction or post-construction BMPs designed to keep materials onsite. Authorized non-storm water dewatering discharges may require a permit because some Regional Water Boards have adopted General Permits for dewatering discharges.

This General Permit prohibits the discharge of storm water that causes or threatens to cause pollution, contamination, or nuisance.

F. Effluent Standards for All Types of Discharges

1. Technology-Based Effluent Limitations

Permits for storm water discharges associated with construction activity must meet all applicable provisions of Sections 301 and 402 of the CWA. These provisions require controls of pollutant discharges that utilize best available technology economically achievable (BAT) for toxic pollutants and non conventional pollutants and best conventional pollutant control technology (BCT) for conventional pollutants. Additionally, these provisions require controls of pollutant discharges to reduce pollutants and any more stringent controls necessary to meet water quality standards. The USEPA has already established such limitations, known as effluent limitation guidelines (ELGs), for some industrial categories. This is not the case with construction discharges. In instances where there are no ELGs the permit writer is to use best professional judgment (BPJ) to establish requirements that the discharger must meet using BAT/BCT technology. This General Permit contains only narrative effluent limitations and does not contain numeric effluent limitations, except for Active Treatment Systems (ATS).

Order No. 2009-0009-DWQ, as originally adopted by the State Water Board on September 2, 2009, contained numeric effluent limitations for pH (within the range of 6.0 and 9.0 pH units) and turbidity (500 NTU) that applied only to Risk Level 3 and LUP Type 3 construction sites. The State Water Board adopted the numeric effluent limitations as technology-based effluent limitations based upon its best professional judgment. The California Building Industry Association, the Building Industry Legal Defense

Foundation, and the California Business Properties Association (petitioners) challenged Order No. 2009-0009-DWQ in *California Building Industry Association et al. v. State Water Resources Control Board*. On December 27, 2011, the Superior Court issued a judgment and writ of mandamus. The Superior Court ruled in favor of the State Water Board on almost all of the issues the petitioners raised, but the Superior Court invalidated the numeric effluent limitations for pH and turbidity for Risk Level 3 and LUP Type 3 sites because it determined that the State Water Board did not have sufficient BMP performance data to support those numeric effluent limitations. Therefore, the Superior Court concluded that the State Water Board did not comply with the federal regulations that apply to the use of best professional judgment. In invalidating the numeric effluent limitations, the Superior Court also suspended two ancillary requirements (a compliance storm event provision and receiving water monitoring at Risk Level 3 and LUP Type 3 sites that violated the numeric effluent limitations) that related solely to the invalidated numeric effluent limitations.

As a result of the Superior Court's writ of mandamus, this Order no longer contains numeric effluent limitations for pH and turbidity, except for ATS. In addition, as a result of the Superior Court's writ of mandamus, the receiving water monitoring requirements for Risk Level 3 and LUP Type 3 sites were suspended until the State Water Board amended this Order to restore the receiving water monitoring requirements. As amended, this Order now requires Risk Level 3 and LUP Type 3 Dischargers with direct discharges to surface waters to conduct receiving water monitoring whenever their effluent exceeds specified receiving water monitoring triggers. The receiving water monitoring triggers were established at the same levels as the previous numeric effluent limitations (effluent pH outside the range of 6.0 and 9.0 pH units or turbidity exceeding 500 NTU). In restoring the receiving water monitoring requirements, the State Water Board determined that it was appropriate to require receiving water monitoring for these types of sites with direct discharges to surface waters that exceeded the receiving water monitoring triggers under any storm event scenarios, because these sites represent the highest threat to receiving water quality. An exceedance of a receiving water monitoring trigger does not constitute a violation of this General Permit. These receiving water monitoring requirements take effect on the effective date of the amendment to this Order.

BAT/BCT technologies not only include passive systems such as conventional runoff and sediment control, but also treatment systems such as coagulation/flocculation using sand filtration, when appropriate. Such technologies allow for effective treatment of soil particles less 0.02 mm (medium silt) in diameter. The discharger must install structural-controls, as necessary, such as erosion and sediment controls that meet BAT and BCT to achieve compliance with water quality standards. The narrative effluent limitations constitute compliance with the requirements of the CWA.

Because the permit is an NPDES permit, there is no legal requirement to address the factors set forth in Water Code sections 13241 and 13263, unless the permit is more stringent than what federal law requires. (See *City of Burbank v. State Water Resources Control Bd.* (2005) 35 Cal.4th 613, 618, 627.) None of the requirements in this permit are more stringent than the minimum federal requirements, which include technology-based requirements achieving BAT/BCT and strict compliance with water quality standards. The inclusion of numeric effluent limitations (NELs) in the permit for Active Treatment Systems does not cause the permit to be more stringent than current federal law. NELs and best management practices are simply two different-methods of achieving the same federal requirement: strict compliance with state water quality standards. Federal law authorizes both narrative and numeric effluent limitations to meet state water quality standards. The use of NELs to achieve compliance with water quality standards is not a more stringent requirement than the use of BMPs. (State Water Board Order No. WQ 2006-0012 (*Boeing*)). Accordingly, the State Water Board does not need to take into account the factors in Water Code sections 13241 and 13263.

The State Water Board has concluded that the establishment of BAT/BCT will not create or aggravate other environmental problems through increases in air pollution, solid waste generation, or energy consumption.—While there may be a slight increase in non-water quality impacts due to the implementation of additional monitoring or the construction of additional BMPs, these impacts will be negligible in comparison with the construction activities taking place on site and would be justified by the water quality benefits associated with compliance.

pH Receiving Water Monitoring Trigger

Given the potential contaminants, the minimum standard method for control of pH in runoff requires the use of preventive measures such as avoiding concrete pours during rainy weather, covering concrete and directing flow away from fresh concrete if a pour occurs during rain, covering scrap drywall and stucco materials when stored outside and potentially exposed to rain, and other housekeeping measures. If necessary, pH-impaired storm water from construction sites can be treated in a filter or settling pond or basin, with additional natural or chemical treatment required to meet pH limits set forth in this permit. The basin or pond acts as a collection point and holds storm water for a sufficient period for the contaminants to be settled out, either naturally or artificially, and allows any additional treatment to take place. The State Water Board considers these techniques to be equivalent to BCT. In determining the pH concentration trigger for discharges, the State Water Board used BPJ to set these limitations.

The chosen trigger was established by calculating three standard deviations above and below the mean pH of runoff from highway construction sites⁷ in California. Proper implementation of BMPs should result in discharges that are within the range of 6.0 to 9.0 pH Units.

Turbidity Receiving Water Monitoring Trigger

The Turbidity receiving water monitoring trigger of 500 NTU is a technology-based trigger and was developed using three different analyses aimed at finding the appropriate threshold to set the technology-based limit to ensure environmental protection, effluent quality and cost-effectiveness. The analyses fell into three, main types: (1) an ecoregion-specific dataset developed by Simon et. al. (2004)⁸; (2) Statewide Regional Water Quality Control Board enforcement data; and (3) published, peer-reviewed studies and reports on in-situ performance of best management practices in terms of erosion and sediment control on active construction sites.

A 1:3 relationship between turbidity (expressed as NTU) and suspended sediment concentration (expressed as mg/L) is assumed based on a review of suspended sediment and turbidity data from three gages used in the USGS National Water Quality Assessment Program:

USGS 11074000 SANTA ANA R BL PRADO DAM CA
USGS 11447650 SACRAMENTO R A FREEPORT CA
USGS 11303500 SAN JOAQUIN R NR VERNALIS CA

The receiving water monitoring trigger represents staff determination that the trigger value is the most practicable based on available data. The turbidity receiving water monitoring trigger represents a bridge between the narrative effluent limitations and receiving water limitations. To support this receiving water monitoring trigger, State Water Board staff analyzed construction site discharge information (monitoring data, estimates) and receiving water monitoring information.

Since the turbidity receiving water monitoring trigger represents an appropriate threshold level expected at a site, compliance with this value does not necessarily represent compliance with either the narrative effluent limitations (as enforced through the BAT/BCT standard) or the receiving water limitations. In the San Diego region, some inland surface waters have a receiving water objective for turbidity equal to 20 NTU. Obviously a discharge up to, but not exceeding, the turbidity receiving water monitoring trigger of

⁷ Caltrans Construction Sites Runoff Characterization Study, 2002. Available at: <http://www.dot.ca.gov/hq/env/stormwater/pdf/CTSW-RT-02-055.pdf>.

500 NTU may still cause or contribute to the exceedance of the 20 NTU standard. Most of the waters of the State are protected by turbidity objectives based on background conditions.

Table 1 - Regional Water Board Basin Plans, Water Quality Objectives for Turbidity

REGIONAL WATER BOARD	WQ Objective	Background/Natural Turbidity	Maximum Increase
1	Based on background	All levels	20%
2	Based on background	> 50 NTU	10%
3	Based on background	0-50 JTU 50-100 JTU > 100 JTU	20% 10 NTU 10%
4	Based on background	0-50 NTU > 50 NTU	20% 10%
5	Based on background	0-5 NTU 5-50 NTU 50-100 NTU >100 NTU	1 NTU 20% 10 NTU 10%
6	Based on background	All levels	10%
7	Based on background	N/A	N/A
8	Based on background	0-50 NTU 50-100 NTU >100 NTU	20% 10 NTU 10%
9	Inland Surface Waters, 20 NTU All others, based on background	 0-50 NTU 50-100 NTU >100 NTU	 20% 10 NTU 10%

Table 2 shows the suspended sediment concentrations at the 1.5 year flow recurrence interval for the 12 ecoregions in California from Simon et. al (2004).

Table 2 - Results of Ecoregion Analysis

Ecoregion	Percent of California Land Area	Median Suspended Sediment Concentration (mg/L)
1	9.1	874
4	0.2	120
5	8.8	35.6
6	20.7	1530
7	7.7	122
8	3.0	47.4
9	9.4	284
13	5.2	143
14	21.7	5150
78	8.1	581
80	2.4	199
81	3.7	503
Area-weighted average		1633

If a 1:3 relationship between turbidity and suspended sediment is assumed, the median turbidity is 544 NTU.

The following table is composed of turbidity readings measured in NTUs from administrative civil liability (ACL) actions for construction sites from 2003 - 2009. This data was derived from the complete listing of construction-related ACLs for the six year period. All ACLs were reviewed and those that included turbidimeter readings at the point of storm water discharge were selected for this dataset.

Table 3 – ACL Sampling Data taken by Regional Water Board Staff

WDID#	Region	Discharger	Turbidity (NTU)
5S34C331884	5S	Bradshaw Interceptor Section 6B	1800
5S05C325110	5S	Bridalwood Subdivision	1670
5S48C336297	5S	Cheyenne at Browns Valley	1629
5R32C314271	5R	Grizzly Ranch Construction	1400
6A090406008	6T	El Dorado County Department of Transportation, Angora Creek	97.4
5S03C346861	5S	TML Development, LLC	1600
6A31C325917	6T	Northstar Village	See Subdata Set

Subdata Set - Turbidity for point of storm water runoff discharge at Northstar Village

Date	Turbidity (NTU)	Location
10/5/2006	900	Middle Martis Creek
11/2/2006	190	Middle Martis Creek
01/04/2007	36	West Fork, West Martis Creek
02/08/2007	180	Middle Martis Creek
02/09/2007	130	Middle Martis Creek
02/09/2007	290	Middle Martis Creek
02/09/2007	100	West Fork, West Martis Creek
02/10/2007	28	Middle Martis Creek
02/10/2007	23	Middle Martis Creek
02/10/2007	32	Middle Martis Creek
02/10/2007	12	Middle Martis Creek
02/10/2007	60	West Fork, West Martis Creek
02/10/2007	34	West Fork, West Martis Creek

A 95% confidence interval for mean turbidity in an ACL order was constructed. The data set used was a small sample size, so the 500 NTU (the value derived as the receiving water monitoring trigger for this General Permit) needed to be verified as a possible population mean. In this case, the population refers to a hypothetical population of turbidity measurements of which our sample of 20 represents. A t-distribution was assumed due to the small sample size:

Mean: 512.23 NTU Standard Deviation: 686.85 Margin of Error: 321.45 Confidence Interval: 190.78 NTU (Low) 833.68 NTU (High)

Based on a constructed 95% confidence interval, an ACL order turbidity measurement will be between 190.78 – 833.68 NTU. 500 NTU falls within this range. Using the same data set, a small-sample hypothesis test was also performed to test if the ACL turbidity data set contains enough information to cast doubt on choosing a 500 NTU as a mean. 500 NTU was again chosen due to its proposed use as an acceptable value. The test was carried out using a 95% confidence interval. Results indicated that the ACL turbidity data set *does not* contain significant sample evidence to reject the claim of 500 NTU as an acceptable mean for the ACL turbidity population.

There are not many published, peer-reviewed studies and reports on in-situ performance of best management practices in terms of erosion and sediment control on active construction sites. The most often cited study is a report titled, “Improving the Cost Effectiveness of Highway Construction Site Erosion and Pollution Control” (Horner, Guedry, and Korten Hof 1990, <http://www.wsdot.wa.gov/Research/Reports/200/200.1.htm>). In a comment letter summarizing this report sent to the State Water Board, the primary author, Dr. Horner, states:

“The most effective erosion control product was wood fiber mulch applied at two different rates along with a bonding agent and grass seed in sufficient time before the tests to achieve germination. Plots treated in this way reduced influent turbidity by more than 97 percent and discharged effluent exhibiting mean and maximum turbidity values of 21 and 73 NTU, respectively. Some other mulch and blanket materials performed nearly as well. These tests demonstrated the control ability of widely available BMPs over a very broad range of erosion potential.”

Other technologies studied in this report produced effluent quality at or near 100 NTU. It is the BPJ of the State Water Board staff that erosion control, while preferred, is not always an option on construction sites and that technology performance in a controlled study showing effluent quality directly leaving a BMP is always easier and cheaper to control than effluent being discharged from the project (edge of property, etc.). As a result, it is the BPJ of the State Water Board staff that it is not cost effective or feasible, at this time, for all risk level and type 3 sites in California to achieve effluent discharges with turbidity values that are less than 100 NTU.

To summarize, the analysis showed that: (1) results of the Simon et. al dataset reveals turbidity values in background receiving water in California’s ecoregions range from 16 NTU to 1716 NTU (with a mean of 544 NTU); (2) based on a constructed 95% confidence interval, construction sites will be subject to administrative civil liability (ACL) when their turbidity measurement falls between 190.78 – 833.68 NTU; and (3) sites with highly controlled discharges employing and maintaining good erosion control practices can discharge effluent from the BMP with turbidity values less than 100 NTU. State Water Board staff has determined, using its BPJ, that it is most cost effective to set the receiving water monitoring trigger for turbidity at 500 NTU.

i. Compliance Storm Event

While this General Permit no longer contains “compliance storm event” exceptions from technology-based NELs, the “compliance storm event” exception from the ATS NELs remain in effect. See Section K of this Fact Sheet, and Attachment F of this General Permit for more information.

a. TMDLs and Waste Load Allocations

Dischargers located within the watershed of a CWA § 303(d) impaired water body, for which a TMDL for sediment has been adopted by the Regional Water Board or USEPA, must comply with the approved TMDL if it identifies “construction activity” or land disturbance as a source of sediment. If it does, the

TMDL should include a specific waste load allocation for this activity/source. The discharger, in this case, may be required by a separate Regional Water Board order to implement additional BMPs, conduct additional monitoring activities, and/or comply with an applicable waste load allocation and implementation schedule. If a specific waste load allocation has been established that would apply to a specific discharge, the Regional Water Board may adopt an order requiring specific implementation actions necessary to meet that allocation. In the instance where an approved TMDL has specified a general waste load allocation to construction storm water discharges, but no specific requirements for construction sites have been identified in the TMDL, dischargers must consult with the state TMDL authority⁹ to confirm that adherence to a SWPPP that meets the requirements of the General Permit will be consistent with the approved TMDL.

2. Determining Compliance with Effluent Standards

a. Technology-Based Numeric Action Levels (NALs)

This General Permit contains technology-based NALs for pH and turbidity, and requirements for effluent monitoring at all Risk level 2 & 3, and LUP Type 2 & 3 sites. Numeric action levels are essentially numeric benchmark values for certain parameters that, if exceeded in effluent sampling, trigger the discharger to take actions. Exceedance of an NAL does not itself constitute a violation of the General Permit. If the discharger fails to take the corrective action required by the General Permit, though, that may constitute a violation.

The primary purpose of NALs is to assist dischargers in evaluating the effectiveness of their on-site measures. Construction sites need to employ many different systems that must work together to achieve compliance with the permit's requirements. The NALs chosen should indicate whether the systems are working as intended.

Another purpose of NALs is to provide information regarding construction activities and water quality impacts. This data will provide the State and Regional Water Boards and the rest of the storm water community with more information about levels and types of pollutants present in runoff and how effective the dischargers BMPs are at reducing pollutants in effluent. The State Water Board also hopes to learn more about the linkage between effluent and receiving water quality. In addition, these requirements will provide information on the mechanics needed to establish compliance monitoring programs at construction sites in future permit deliberations.

i. pH

The chosen limits were established by calculating one standard deviation above and below the mean pH of runoff from highway construction sites¹⁰ in California. Proper implementation of BMPs should result in discharges that are within the range of 6.5 to 8.5 pH Units.

⁹ <http://www.waterboards.ca.gov/tmdl/tmdl.html>.

¹⁰ Caltrans Construction Sites Runoff Characterization Study, 2002. Available at: <http://www.dot.ca.gov/hq/env/stormwater/pdf/CTSW-RT-02-055.pdf>.

The Caltrans study included 33 highway construction sites throughout California over a period of four years, which included 120 storm events. All of these sites had BMPs in place that would be generally implemented at all types of construction sites in California.

ii. *Turbidity*

BPJ was used to develop an NAL that can be used as a learning tool to help dischargers improve their site controls, and to provide meaningful information on the effectiveness of storm water controls. A statewide turbidity NAL has been set at 250 NTU.

G. Receiving Water Limitations

Construction-related activities that cause or contribute to an exceedance of water quality standards must be addressed. The dynamic nature of construction activity gives the discharger the ability to quickly identify and monitor the source of the exceedances. This is because when storm water mobilizes sediment, it provides visual cues as to where corrective actions should take place and how effective they are once implemented.

This General Permit requires that storm water discharges and authorized non-storm water discharges must not contain pollutants that cause or contribute to an exceedance of any applicable water quality objective or water quality standards. The monitoring requirements in this General Permit for sampling and analysis procedures will help determine whether BMPs installed and maintained are preventing pollutants in discharges from the construction site that may cause or contribute to an exceedance of water quality standards.

Water quality standards consist of designated beneficial uses of surface waters and the adoption of ambient criteria necessary to protect those uses. When adopted by the State Water Board or a Regional Water Board, the ambient criteria are termed “water quality objectives.” If storm water runoff from construction sites contains pollutants, there is a risk that those pollutants could enter surface waters and cause or contribute to an exceedance of water quality standards. For that reason, dischargers should be aware of the applicable water quality standards in their receiving waters. (The best method to ensure compliance with receiving water limitations is to implement BMPs that prevent pollutants from contact with storm water or from leaving the construction site in runoff.)

In California, water quality standards are published in the Basin Plans adopted by each Regional Water Board, the California Toxics Rule (CTR), the National Toxics Rule (NTR), and the Ocean Plan.

Dischargers can determine the applicable water quality standards by contacting Regional Water Board staff or by consulting one of the following sources. The actual Basin Plans that contain the water quality standards can be viewed at the website of the appropriate Regional Water Board. (<http://www.waterboards.ca.gov/regions.html>), the State Water Board site for statewide plans (<http://www.waterboards.ca.gov/plnspols/index.html>), or the USEPA regulations for the NTR and CTR (40 C.F.R. §§ 131.36-38). Basin Plans and statewide plans are also available by mail from the appropriate Regional Water Board or the State Water Board. The USEPA regulations are available at <http://www.epa.gov/>. Additional information concerning water quality standards can be accessed through http://www.waterboards.ca.gov/stormwtr/gen_const.html.

H. Training Qualifications and Requirements

The Blue Ribbon Panel (BRP) made the following observation about the lack of industry-specific training requirements:

“Currently, there is no required training or certification program for contractors, preparers of soil erosion and sediment control Storm Water Pollution Prevention Plans, or field inspectors.”

Order 99-08-DWQ required that all dischargers train their employees on how to comply with the permit, but it did not specify a curriculum or certification program. This has resulted in inconsistent implementation by all affected parties - the dischargers, the local governments where the construction activity occurs, and the regulators required to enforce 99-08-DWQ. This General Permit requires Qualified SWPPP Developers and practitioners to obtain appropriate training, and makes this curriculum mandatory two years after adoption, to allow time for course completion. The State and Regional Water Board are working with many stakeholders to develop the curriculum and mechanisms needed to develop and deliver the courses.

To ensure that the preparation, implementation, and oversight of the SWPPP is sufficient for effective pollution prevention, the Qualified SWPPP Developer and Qualified SWPPP Practitioners responsible for creating, revising, overseeing, and implementing the SWPPP must attend a State Water Board-sponsored or approved Qualified SWPPP Developer and Qualified SWPPP Practitioner training course.

I. Sampling, Monitoring, Reporting and Record Keeping

1. Traditional Construction Monitoring Requirements

This General Permit requires visual monitoring at all sites, and effluent water quality at all Risk Level 2 & 3 sites. It requires receiving water monitoring at some Risk Level 3 sites. All sites are required to submit annual reports, which contain various types of information, depending on the site characteristics and events. A summary of the monitoring and reporting requirements is found in Table 4.

Table 4 - Required Monitoring Elements for Risk Levels

	Visual	Non-visible Pollutant	Effluent	Receiving Water
Risk Level 1			where applicable	not required
Risk Level 2			pH, turbidity	not required
Risk Level 3	three types required for all Risk Levels: non-storm water, pre-rain and post-rain	As needed for all Risk Levels (see below)	pH, turbidity	(if Receiving Water Monitoring Trigger exceeded) pH, turbidity and SSC. Bioassessment for sites 30 acres or larger.

a. Visual

All dischargers are required to conduct quarterly, non-storm water visual inspections. For these inspections, the discharger must visually observe each drainage area for the presence of (or indications of prior) unauthorized and authorized non-storm water discharges and their sources. For storm-related inspections, dischargers must visually observe storm water discharges at all discharge locations within two business days after a qualifying event. For this requirement, a qualifying rain event is one producing precipitation of ½ inch or more of discharge. Dischargers must conduct a post-storm event inspection to (1) identify whether BMPs were adequately designed, implemented, and effective, and (2) identify any additional BMPs necessary and revise the SWPPP accordingly. Dischargers must maintain on-site records of all visual observations, personnel performing the observations, observation dates, weather conditions, locations observed, and corrective actions taken in response to the observations.

b. Non-Visible Pollutant Monitoring

This General Permit requires that all dischargers develop a sampling and analysis strategy for monitoring pollutants that are not visually detectable in storm water. Monitoring for non-visible pollutants must be required at any construction site when the exposure of construction materials occurs and where a discharge can cause or contribute to an exceedance of a water quality objective.

Of significant concern for construction discharges are the pollutants found in materials used in large quantities at construction sites throughout California and exposed throughout the rainy season, such as cement, flyash, and other recycled materials or by-products of combustion. The water quality standards that apply to these materials will depend on their composition. Some of the more common storm water pollutants from construction activity are not CTR pollutants. Examples of non-visible pollutants include glyphosate (herbicides), diazinon and chlorpyrifos (pesticides), nutrients (fertilizers), and molybdenum (lubricants). The use of diazinon and chlorpyrifos is a common practice among landscaping professionals and may trigger sampling and analysis requirements if these materials come into contact with storm water. High pH values from cement and gypsum, high pH and SSC from wash waters, and chemical/fecal contamination from portable toilets, also are not CTR pollutants. Although some of these constituents do have numeric water quality objectives in individual Basin Plans, many do not and are subject only to narrative water quality standards (i.e. not causing toxicity). Dischargers are encouraged to discuss these issues with Regional Water Board staff and other storm water quality professionals.

The most effective way to avoid the sampling and analysis requirements, and to ensure permit compliance, is to avoid the exposure of construction materials to precipitation and storm water runoff. Materials that are not exposed do not have the potential to enter storm water runoff, and therefore receiving waters sampling is not required. Preventing contact between storm water and construction materials is one of the most important BMPs at any construction site.

Preventing or eliminating the exposure of pollutants at construction sites is not always possible. Some materials, such as soil amendments, are designed to be used in a manner that will result in exposure to storm water. In these cases, it is important to make sure that these materials are applied according to the manufacturer's instructions and at a time when they are unlikely to be washed away. Other construction materials can be exposed when storage, waste disposal or the application of the material is done in a manner not protective of water quality. For these situations, sampling is required unless there is capture and containment of all storm water that has been exposed. In cases where construction materials may be exposed to storm water, but the storm water is contained and is not allowed to run off the site, sampling will only be required when inspections show that the containment failed or is breached, resulting in potential exposure or discharge to receiving waters.

The discharger must develop a list of potential pollutants based on a review of potential sources, which will include construction materials soil amendments, soil treatments, and historic contamination at the site. The discharger must review existing environmental and real estate documentation to determine the potential for pollutants that could be present on the construction site as a result of past land use activities.

Good sources of information on previously existing pollution and past land uses include:

- i. Environmental Assessments;
- ii. Initial Studies;
- iii. Phase 1 Assessments prepared for property transfers; and
- iv. Environmental Impact Reports or Environmental Impact Statements prepared under the requirements of the National Environmental Policy Act or the California Environmental Quality Act.

In some instances, the results of soil chemical analyses may be available and can provide additional information on potential contamination.

The potential pollutant list must include all non-visible pollutants that are known or should be known to occur on the construction site including, but not limited to, materials that:

- i. are being used in construction activities;
- ii. are stored on the construction site;
- iii. were spilled during construction operations and not cleaned up;
- iv. were stored (or used) in a manner that created the potential for a release of the materials during past land use activities;
- v. were spilled during previous land use activities and not cleaned up; or
- vi. were applied to the soil as part of past land use activities.

C. Effluent Monitoring

Federal regulations¹¹ require effluent monitoring for discharges subject to NALs. Subsequently, all Risk Level 2 and 3 dischargers must perform sampling and analysis of effluent discharges to characterize discharges associated with construction activity from the entire area disturbed by the project. Dischargers must collect samples of stored or contained storm water that is discharged subsequent to a storm event producing precipitation of ½ inch or more at the time of discharge.

Table 5 - Storm Water Effluent Monitoring Requirements by Risk Level

	Frequency	Effluent Monitoring (Section E, below)
Risk Level 1	when applicable	non-visible pollutant parameters (if applicable)
Risk Level 2	Minimum of 3 samples per day during qualifying rain event characterizing discharges associated with construction activity from the entire project disturbed area.	pH, turbidity, and non-visible pollutant parameters (if applicable)
Risk Level 3	Minimum of 3 samples per day during qualifying rain event characterizing discharges associated with construction activity from the entire project disturbed area.	pH, turbidity, and non-visible pollutant parameters if applicable

Risk Level 1 dischargers must analyze samples for:

- i. any parameters indicating the presence of pollutants identified in the pollutant source assessment required in Attachment C contained in the General Permit.

¹¹ 40 C.F.R. § 122.44.

Risk Level 2 dischargers must analyze samples for:

- i. pH and turbidity;
- ii. any parameters indicating the presence of pollutants identified in the pollutant source assessment required in Attachment D contained in the General Permit, and
- iii. any additional parameters for which monitoring is required by the Regional Water Board.

Risk Level 3 dischargers must analyze samples for:

- i. pH, turbidity;
- ii. any parameters indicating the presence of pollutants identified in the pollutant source assessment required in Attachment E contained in the General Permit, and
- iii. any additional parameters for which monitoring is required by the Regional Water Board.

2. Linear Monitoring and Sampling Requirements

Attachment A, establishes minimum monitoring and reporting requirements for all LUPs. It establishes different monitoring requirements depending on project complexity and risk to water quality. The monitoring requirements for Type 1 LUPs are less than Type 2 & 3 projects because Type 1 projects have a lower potential to impact water quality.

A discharger shall prepare a monitoring program prior to the start of construction and immediately implement the program at the start of construction for LUPs. The monitoring program must be implemented at the appropriate level to protect water quality at all times throughout the life of the project.

a. Type 1 LUP Monitoring Requirements

A discharger must conduct daily visual inspections of Type 1 LUPs during working hours while construction activities are occurring. Inspections are to be conducted by qualified personnel and can be conducted in conjunction with other daily activities. Inspections will be conducted to ensure the BMPs are adequate, maintained, and in place at the end of the construction day. The discharger will revise the SWPPP, as appropriate, based on the results of the daily inspections. Inspections can be discontinued in non-active construction areas where soil disturbing activities have been completed and final stabilization has been achieved (e.g., trench has been paved, substructures have been installed, and successful final vegetative cover or other stabilization criteria have been met).

A discharger shall implement the monitoring program for inspecting Type 1 LUPs. This program requires temporary and permanent stabilization BMPs after active construction is completed. Inspection activities will continue until adequate permanent stabilization has been established and will continue in areas where re-vegetation is chosen until minimum vegetative coverage has been established. Photographs shall be taken during site inspections and submitted to the State Water Board.

b. Type 2 & 3 LUP Monitoring Requirements

A discharger must conduct daily visual inspections of Type 2 & 3 LUPs during working hours while construction activities are occurring. Inspections are to be conducted by qualified personnel and can be in conjunction with other daily activities.

All dischargers of Type 2 & 3 LUPs are required to conduct inspections by qualified personnel of the construction site during normal working hours prior to all anticipated storm events and after actual storm events. During extended storm events, the discharger shall conduct inspections during normal working hours for each 24-hour period. Inspections can be discontinued in non-active construction areas where soil disturbing activities have been completed and final stabilization has been achieved (e.g., trench has been paved, substructures installed, and successful vegetative cover or other stabilization criteria have been met).

The goals of these inspections are (1) to identify areas contributing to a storm water discharge; (2) to evaluate whether measures to reduce pollutant loadings identified in the SWPPP are adequate and properly installed and functioning in accordance with the terms of the General Permit; and (3) to determine whether additional control practices or corrective maintenance activities are needed. Equipment, materials, and workers must be available for rapid response to failures and emergencies. All corrective maintenance to BMPs shall be performed as soon as possible, depending upon worker safety.

All dischargers shall develop and implement a monitoring program for inspecting Type 2 & 3 LUPs that require temporary and permanent stabilization BMPs after active construction is completed. Inspections will be conducted to ensure the BMPs are adequate and maintained. Inspection activities will continue until adequate permanent stabilization has been established and will continue in areas where revegetation is chosen until minimum vegetative coverage has been established.

A log of inspections conducted before, during, and after the storm events must be maintained in the SWPPP. The log will provide the date and time of the inspection and who conducted the inspection. Photographs must be taken during site inspections and submitted to the State Water Board.

C. Sampling Requirements for all LUP Project Types

LUPs are also subject to sampling and analysis requirements for visible pollutants (i.e., sedimentation/siltation, turbidity) and for non-visible pollutants.

Sampling for visible pollutants is required for Type 2 & 3 LUPs.

Non-visible pollutant monitoring is required for pollutants associated with construction sites and activities that (1) are not visually detectable in storm water discharges, and (2) are known or should be known to occur on the construction site, and (3) could cause or contribute to an exceedance of water quality objectives in the receiving waters. Sample collection for non-visible pollutants must only be required (1) during a storm event when pollutants associated with construction activities may be discharged with storm water runoff due to a spill, or in the event there was a breach, malfunction, failure, and/or leak of any BMP, and (2) when the discharger has failed to adequately clean the area of material and pollutants. Failure to implement appropriate BMPs will trigger the same sampling requirements as those required for a breach, malfunction and/or leak, or when the discharger has failed to implement appropriate BMPs prior to the next storm event.

Additional monitoring parameters may be required by the Regional Water Boards.

It is not anticipated that many LUPs will be required to collect samples for pollutants not visually detected in runoff due to the nature and character of the construction site and activities as previously described in this fact sheet. Most LUPs are constructed in urban areas with public access (e.g., existing roadways, road shoulders, parking areas, etc.). This raises a concern regarding the potential contribution of pollutants from vehicle use and/or from normal activities of the public (e.g., vehicle washing, landscape fertilization, pest spraying, etc.) in runoff from the project site. Since the dischargers are not the land owners of the project area and are not able to control the presence of these pollutants in the storm water that runs through their projects, it is not the intent of this General Permit to require dischargers to sample for these pollutants. This General Permit does not require the discharger to sample for these types of pollutants except where the discharger has brought materials onsite that contain these pollutants and when a condition (e.g., breach, failure, etc.) described above occurs.

3. Receiving Water Monitoring

In order to ensure that receiving water limitations are met, discharges subject to receiving water monitoring triggers (i.e., Risk Level 3 and LUP Type 3 sites) or numeric effluent limitations (i.e., Risk Level 3 and LUP Type 3 sites utilizing ATS with direct discharges into receiving waters) must also monitor the downstream receiving water(s) for turbidity, SSC, and pH (if applicable) when a receiving water monitoring trigger or NEL is exceeded.

a. Bioassessment Monitoring

This General Permit requires a bioassessment of receiving waters for dischargers of Risk Level 3 or LUP Type 3 construction projects equal to or larger than 30 acres with direct discharges into receiving waters. Benthic macroinvertebrate samples will be taken upstream and downstream of the site's discharge point in the receiving water. Bioassessments measure the quality of the stream by analyzing the aquatic life present. Higher levels of appropriate aquatic species tend to indicate a healthy stream; whereas low levels of organisms can indicate stream degradation. Active construction sites have the potential to discharge large amounts of sediment and pollutants into receiving waters. Requiring a bioassessment for large project sites, with the most potential to impact water quality, provides a snapshot of the health of the receiving water prior to initiation of construction activities. This snapshot can be used in comparison to the health of the receiving water after construction has commenced.

Each ecoregion (biologically and geographically related area) in the State has a specific yearly peak time where stream biota is in a stable and abundant state. This time of year is called an Index Period. The bioassessment requirements in this General Permit, requires benthic macroinvertebrate sampling within a sites index period. The State Water Board has developed a map designating index periods for the ecoregions in the State (see State Water Board Website).

This General Permit requires the bioassessment methods to be in accordance with the Surface Water Ambient Monitoring Program (SWAMP) in order to provide data consistency within the state as well as generate useable biological stream data.

Table 6 - Receiving Water Monitoring Requirements

	Receiving Water Monitoring Parameters
Risk Level 1 /LUP Type 1	not required
Risk Level 2 / LUP Type 2	not required
Risk Level 3 / LUP Type 3	If Receiving Water Monitoring Trigger exceeded: pH (if applicable), turbidity, and SSC. Bioassessment for sites 30 acres or larger.

4. Reporting Requirements

a. NAL Exceedance Report

All Risk Level 3 and LUP Type 3 dischargers must electronically submit all storm event sampling results to the State And Regional Boards, via the electronic data system, no later than 10 days after the conclusion of the storm event.

b. Annual Report

All dischargers must prepare and electronically submit an annual report no later than September 1 of each year using the Storm water Multi-Application Reporting and Tracking System (SMARTS). The

Annual Report must include a summary and evaluation of all sampling and analysis results, original laboratory reports, chain of custody forms, a summary of all corrective actions taken during the compliance year, and identification of any compliance activities or corrective actions that were not implemented.

5. Record Keeping

According to 40 C.F.R. Parts 122.21(p) and 122.41(j), the discharger is required to retain paper or electronic copies of all records required by this General Permit for a period of at least three years from the date generated or the date submitted to the State Water Board or Regional Water Boards. A discharger must retain records for a period beyond three years as directed by Regional Water Board.

J. Risk Determination

1. Traditional Projects

a. Overall Risk Determination

There are two major requirements related to site planning and risk determination in this General Permit. The project's overall risk is broken up into two elements – (1) project sediment risk (the relative amount of sediment that can be discharged, given the project and location details) and (2) receiving water risk (the risk sediment discharges pose to the receiving waters).

Project Sediment Risk:

Project Sediment Risk is determined by multiplying the R, K, and LS factors from the Revised Universal Soil Loss Equation (RUSLE) to obtain an estimate of project-related bare ground soil loss expressed in tons/acre. The RUSLE equation is as follows:

$$A = (R)(K)(LS)(C)(P)$$

Where: A = the rate of sheet and rill erosion

R = rainfall-runoff erosivity factor

K = soil erodibility factor

LS = length-slope factor

C = cover factor (erosion controls)

P = management operations and support practices (sediment controls)

The C and P factors are given values of 1.0 to simulate bare ground conditions.

There is a map option and a manual calculation option for determining soil loss. For the map option, the R factor for the project is calculated using the online calculator at <http://cfpub.epa.gov/npdes/stormwater/LEW/lewCalculator.cfm>. The product of K and LS are shown on Figure 1. To determine soil loss in tons per acre, the discharger multiplies the R factor times the value for K times LS from the map.

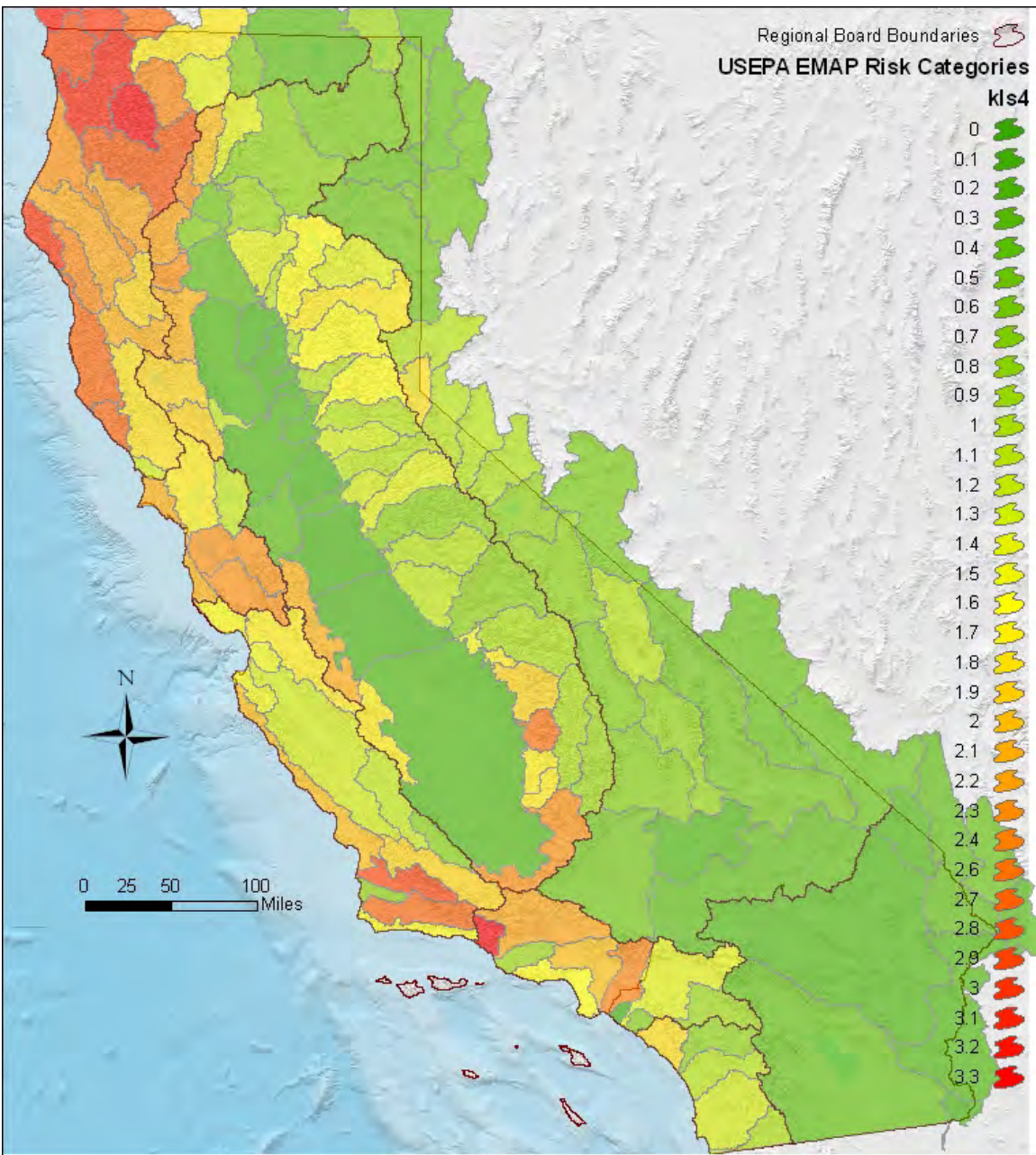

State Water Resources Control Board, January 15, 2008

Figure 1 -Statewide Map of K * LS

For the manual calculation option, the R factor for the project is calculated using the online calculator at <http://cfpub.epa.gov/npdes/stormwater/LEW/lewCalculator.cfm>. The K and LS factors are determined using Appendix 1.

Soil loss of less than 15 tons/acre is considered **low** sediment risk.
 Soil loss between 15 and 75 tons/acre is **medium** sediment risk.
 Soil loss over 75 tons/acre is considered **high** sediment risk.

The soil loss values and risk categories were obtained from mean and standard deviation RKLS values from the USEPA EMAP program. High risk is the mean RKLS value plus two standard deviations. Low risk is the mean RKLS value minus two standard deviations.

Receiving Water Risk:

Receiving water risk is based on whether a project drains to a sediment-sensitive waterbody. A sediment-sensitive waterbody is either

- on the most recent 303d list for waterbodies impaired for sediment;
- has a USEPA-approved Total Maximum Daily Load implementation plan for sediment; **or**
- has the beneficial uses of COLD, SPAWN, and MIGRATORY.

A project that meets at least one of the three criteria has a high receiving water risk. A list of sediment-sensitive waterbodies will be posted on the State Water Board’s website. It is anticipated that an interactive map of sediment sensitive water bodies in California will be available in the future.

The Risk Levels have been altered by eliminating the possibility of a Risk Level 4, and expanding the constraints for Risk Levels 1, 2, and 3. Therefore, projects with high receiving water risk and high sediment risk will be considered a Risk Level 3 risk to water quality.

In response to public comments, the Risk Level requirements have also been changed such that Risk Level 1 projects will be subject to minimum BMP and visual monitoring requirements, Risk Level 2 projects will be subject to NALs and some additional monitoring requirements, and Risk Level 3 projects will be subject to NALs, and more rigorous monitoring requirements such as receiving water monitoring and in some cases bioassessment.

Table 7 - Combined Risk Level Matrix

Combined Risk Level Matrix			
Receiving Water Risk		Sediment Risk	
		Low	Medium
	Low	Level 1	Level 2
High	Level 2		Level 3

b. Effluent Standards

All dischargers are subject to the narrative effluent limitations specified in the General Permit. The narrative effluent limitations require storm water discharges associated with construction activity to meet all applicable provisions of Sections 301 and 402 of the CWA. These provisions require controls of pollutant discharges that utilize BAT and BCT to reduce pollutants and any more stringent controls necessary to meet water quality standards.

Risk Level 2 dischargers that pose a medium risk to water quality are subject to technology-based NALs for pH and turbidity. Risk Level 3 dischargers that pose a high risk to water quality are also subject to technology-based NALs for pH and turbidity.

C. Good Housekeeping

Proper handling and managing of construction materials can help minimize threats to water quality. The discharger must consider good housekeeping measures for: construction materials, waste management, vehicle storage & maintenance, landscape materials, and potential pollutant sources. Examples include; conducting an inventory of products used, implementing proper storage & containment, and properly cleaning all leaks from equipment and vehicles.

d. Non-Storm Water Management

Non-storm water discharges directly connected to receiving waters or the storm drain system have the potential to negatively impact water quality. The discharger must implement measures to control all non-storm water discharges during construction, and from dewatering activities associated with construction. Examples include; properly washing vehicles in contained areas, cleaning streets, and minimizing irrigation runoff.

e. Erosion Control

The best way to minimize the risk of creating erosion and sedimentation problems during construction is to disturb as little of the land surface as possible by fitting the development to the terrain. When development is tailored to the natural contours of the land, little grading is necessary and, consequently, erosion potential is lower.¹⁴ Other effective erosion control measures include: preserving existing vegetation where feasible, limiting disturbance, and stabilizing and re-vegetating disturbed areas as soon as possible after grading or construction activities. Particular attention must be paid to large, mass-graded sites where the potential for soil exposure to the erosive effects of rainfall and wind is great and where there is potential for significant sediment discharge from the site to surface waters. Until permanent vegetation is established, soil cover is the most cost-effective and expeditious method to protect soil particles from detachment and transport by rainfall. Temporary soil stabilization can be the single most important factor in reducing erosion at construction sites. The discharger is required to consider measures such as: covering disturbed areas with mulch, temporary seeding, soil stabilizers, binders, fiber rolls or blankets, temporary vegetation, and permanent seeding. These erosion control measures are only examples of what should be considered and should not preclude new or innovative approaches currently available or being developed. Erosion control BMPs should be the primary means of preventing storm water contamination, and sediment control techniques should be used to capture any soil that becomes eroded.¹²

Risk Level 3 dischargers pose a higher risk to water quality and are therefore additionally required to ensure that post-construction soil loss is equivalent to or less than the pre-construction levels.

f. Sediment Control

Sediment control BMPs should be the secondary means of preventing storm water contamination. When erosion control techniques are ineffective, sediment control techniques should be used to capture any soil that becomes eroded. The discharger is required to consider perimeter control measures such as: installing silt fences or placing straw wattles below slopes. These sediment control measures are only

¹² U.S. Environmental Protection Agency. 2007. Developing Your Storm Water Pollution Prevention Plan: A Guide for Construction Sites.

examples of what should be considered and should not preclude new or innovative approaches currently available or being developed.

Because Risk Level 2 and 3 dischargers pose a higher risk to water quality, additional requirements for the application of sediment controls are imposed on these projects. This General Permit also authorizes the Regional Water Boards to require Risk Level 3 dischargers to implement additional site-specific sediment control requirements if the implementation of other erosion or sediment controls are not adequately protecting the receiving waters.

g. Run-on and Runoff Control

Inappropriate management of run-on and runoff can result in excessive physical impacts to receiving waters from sediment and increased flows. The discharger is required to manage all run-on and runoff from a project site. Examples include: installing berms and other temporary run-on and runoff diversions.

Risk Level 1 dischargers with lower risks to impact water quality are not subject to the run-on and runoff control requirements unless an evaluation deems them necessary or visual inspections show that such controls are required.

h. Inspection, Maintenance and Repair

All measures must be periodically inspected, maintained and repaired to ensure that receiving water quality is protected. Frequent inspections coupled with thorough documentation and timely repair is necessary to ensure that all measures are functioning as intended.

i. Rain Event Action Plan (REAP)

A Rain Event Action Plan (REAP) is a written document, specific for each rain event. A REAP should be designed that when implemented it protects all exposed portions of the site within 48 hours of any likely precipitation event forecast of 50% or greater probability.

This General Permit requires Risk Level 2 and 3 dischargers to develop and implement a REAP designed to protect all exposed portions of their sites within 48 hours prior to any likely precipitation event. The REAP requirement is designed to ensure that the discharger has adequate materials, staff, and time to implement erosion and sediment control measures that are intended to reduce the amount of sediment and other pollutants generated from the active site. A REAP must be developed when there is likely a forecast of 50% or greater probability of precipitation in the project area. (The National Oceanic and Atmospheric Administration (NOAA) defines a chance of precipitation as a probability of precipitation of 30% to 50% chance of producing precipitation in the project area.¹³ NOAA defines the probability of precipitation (PoP) as the likelihood of occurrence (expressed as a percent) of a measurable amount (0.01 inch or more) of liquid precipitation (or the water equivalent of frozen precipitation) during a specified period of time at any given point in the forecast area.) Forecasts are normally issued for 12-hour time periods. Descriptive terms for uncertainty and aerial coverage are used as follows:

Table 8 -National Oceanic and Atmospheric Administration (NOAA) Definition of Probability of Precipitation (PoP)

¹³ <http://www.crh.noaa.gov/lot/severe/wxterms.php>.

PoP	Expressions of Uncertainty	Aerial Coverage
0%	none used	none used
10%	none used	isolated
20%	slight chance	isolated
30-50%	chance	scattered
60-70%	likely	numerous
80-100%	none used	none used

The discharger must obtain the precipitation forecast information from the National Weather Service Forecast Office (<http://www.srh.noaa.gov/>).

2. Linear Projects

a. Linear Risk Determination

LUPs vary in complexity and water quality concerns based on the type of project. This General Permit has varying application requirements based on the project's risk to water quality. Factors that lead to the characterization of the project include location, sediment risk, and receiving water risk.

Based on the location and complexity of a project area or project section area, LUPs are separated into project types. As described below, LUPs have been categorized into three project types.

i. *Type 1 LUPs*

Type 1 LUPs are those construction projects where:

- (1) 70 percent or more of the construction activity occurs on a paved surface and where areas disturbed during construction will be returned to preconstruction conditions or equivalent protection established at the end of the construction activities for the day, or
- (2) greater than 30 percent of construction activities occur within the non-paved shoulders or land immediately adjacent to paved surfaces, or where construction occurs on unpaved improved roads, including their shoulders or land immediately adjacent to them where:

Areas disturbed during construction will be returned to pre-construction conditions or equivalent protection established at the end of the construction activities for the day to minimize the potential for erosion and sediment deposition, and

Areas where established vegetation was disturbed during construction will be stabilized and re-vegetated by the end of project. When required, adequate temporary stabilization Best Management Practices (BMPs) will be installed and maintained until vegetation is established to meet minimum cover requirements established in this General Permit for final stabilization.

Type 1 LUPs typically do not have a high potential to impact storm water quality because (1) these construction activities are not typically conducted during a rain event, (2) these projects are normally constructed over a short period of time¹⁴, minimizing the duration that pollutants could potentially be exposed to rainfall; and (3) disturbed soils such as those from trench excavation are required to be hauled away, backfilled into the trench, and/or covered (e.g., metal plates, pavement, plastic covers over spoil piles) at the end of the construction day.

Type 1 LUPs are determined during the risk assessment found in Attachment A.1 to be 1) low sediment risk and low receiving water risk; 2) low sediment risk and medium receiving water risk; and 3) medium sediment risk and low receiving water risk.

This General Permit requires the discharger to ensure a SWPPP is developed for these construction activities that is specific to project type, location and characteristics.

ii. Type 2 LUPs:

Type 2 projects are determined to have a combination of High, Medium, and Low project sediment risk along with High, Medium, and Low receiving water risk. Like Type 1 projects, Type 2 projects are typically constructed over a short period of time. However, these projects have a higher potential to impact water quality because they:

- (1) typically occur outside the more urban/developed areas;
- (2) have larger areas of soil disturbance that are not closed or restored at the end of the day;
- (3) may have onsite stockpiles of soil, spoil and other materials;
- (4) cross or occur in close proximity to a wide variety of sensitive resources that may include, but are not limited to, steep topography and/or water bodies; and
- (5) have larger areas of disturbed soils that may be exposed for a longer time interval before final stabilization, cleanup and/or reclamation occurs.

This General Permit requires the discharger to develop and implement a SWPPP for these construction activities that are specific for project type, location and characteristics.

iii. Type 3 LUPs:

¹⁴ Short period of time refers to a project duration of weeks to months, but typically less than one year in duration.

Type 3 projects are determined to have a combination of High and Medium project sediment risk along with High and Medium receiving water risk. Similar to Type 2 projects, Type 3 projects have a higher potential to impact water quality because they:

- (1) typically occur outside of the more urban/developed areas;
- (2) have larger areas of soil disturbance that are not closed or restored at the end of the day;
- (3) may have onsite stockpiles of soil, spoil and other materials;
- (4) cross or occur in close proximity to a wide variety of sensitive resources that may include, but are not limited to, steep topography and/or water bodies; and
- (5) have larger areas of disturbed soils that may be exposed for a longer time interval before final stabilization, cleanup and/or reclamation occurs.

This General Permit requires the discharger to develop and implement a SWPPP for these construction activities that are specific for project type, location, and characteristics.

b. Linear Effluent Standards

All LUPs are subject to the narrative effluent limitations specified in the General Permit.

Type 2 and Type 3 projects are subject to technology-based NALs for pH and turbidity.

c. Linear Good Housekeeping

Improper use and handling of construction materials could potentially cause a threat to water quality. In order to ensure proper site management of these construction materials, all LUP dischargers must comply with a minimum set of Good Housekeeping measures specified in Attachment A of this General Permit.

d. Linear Non-Storm Water Management

In order to ensure control of all non-storm water discharges during construction, all LUP dischargers must comply with the Non-Storm Water Management measures specified in Attachment A of this General Permit.

e. Linear Erosion Control

This General Permit requires all LUP dischargers to implement effective wind erosion control measures, and soil cover for inactive areas. Type 3 LUPs posing a higher risk to water quality are additionally required to ensure the post-construction soil loss is equivalent to or less than the pre-construction levels.

f. Linear Sediment Control

In order to ensure control and containment of all sediment discharges, all LUP dischargers must comply with the general Sediment Control measures specified in Attachment A or this General Permit. Additional requirements for sediment controls are imposed on Type 2 & 3 LUPs due to their higher risk to water quality.

g. Linear Run-on and Runoff Control

Discharges originating outside of a project's perimeter and flowing onto the property can adversely affect the quantity and quality of discharges originating from a project site. In order to ensure proper management of run-on and runoff, all LUPs must comply with the run-on and runoff control measures specified in Attachment A of this General Permit. Due to the lower risk of impacting water quality, Type 1 LUPs are not required to implement run-on and runoff controls unless deemed necessary by the discharger.

h. Linear Inspection, Maintenance and Repair

Proper inspection, maintenance, and repair activities are important to ensure the effectiveness of on-site measures to control water quality. In order to ensure that inspection, maintenance, and repair activities are adequately performed, the all LUP dischargers are required to comply with the Inspection, Maintenance, and Repair requirements specified in Attachment A of this General Permit.

K. ATS¹⁵ Requirements

There are instances on construction sites where traditional erosion and sediment controls do not effectively control accelerated erosion. Under such circumstances, or under circumstances where storm water discharges leaving the site may cause or contribute to an exceedance of a water quality standard, the use of an Active Treatment System (ATS) may be necessary. Additionally, it may be appropriate to use an ATS when site constraints inhibit the ability to construct a correctly sized sediment basin, when clay and/or highly erosive soils are present, or when the site has very steep or long slope lengths.¹⁶

Although treatment systems have been in use in some form since the mid-1990s, the ATS industry in California is relatively young, and detailed regulatory standards have not yet been developed. Many developers are using these systems to treat storm water discharges from their construction sites. The new ATS requirements set forth in this General Permit are based on those in place for small wastewater treatment systems, ATS regulations from the Central Valley Regional Water Quality Control Board (September 2005 memorandum "2005/2006 Rainy Season – Monitoring Requirements for Storm Water Treatment Systems that Utilize Chemical Additives to Enhance Sedimentation"), the Construction Storm Water Program at the State of Washington's Department of Ecology, as well as recent advances in technology and knowledge of coagulant performance and aquatic safety.

The effective design of an ATS requires a detailed survey and analysis of site conditions. With proper planning, ATS performance can provide exceptional water quality discharge and prevent significant impacts to surface water quality, even under extreme environmental conditions.

These systems can be very effective in reducing the sediment in storm water runoff, but the systems that use additives/polymers to enhance sedimentation also pose a potential risk to water quality (e.g., operational failure, equipment failure, additive/polymer release, etc.). The State Water Board is concerned about the potential acute and chronic impacts that the polymers and other chemical additives may have on fish and aquatic organisms if released in sufficient quantities or concentrations. In addition

¹⁵ An ATS is a treatment system that employs chemical coagulation, chemical flocculation, or electrocoagulation in order to reduce turbidity caused by fine suspended sediment.

¹⁶ Pitt, R., S. Clark, and D. Lake. 2006. Construction Site Erosion and Sediment Controls: Planning, Design, and Performance. DEStech Publications. Lancaster, PA. 370pp.

to anecdotal evidence of polymer releases causing aquatic toxicity in California, the literature supports this concern.¹⁷ For example, cationic polymers have been shown to bind with the negatively charged gills of fish, resulting in mechanical suffocation.¹⁸ Due to the potential toxicity impacts, which may be caused by the release of additives/polymers into receiving waters, this General Permit establishes residual polymer monitoring and toxicity testing requirements have been established in this General Permit for discharges from construction sites that utilize an ATS in order to protect receiving water quality and beneficial uses.

The primary treatment process in an ATS is coagulation/flocculation. ATS's operate on the principle that the added coagulant is bound to suspended sediment, forming floc, which is gravitationally settled in tanks or a basin, or removed by sand filters. A typical installation utilizes an injection pump upstream from the clarifier tank, basin, or sand filters, which is electronically metered to both flow rate and suspended solids level of the influent, assuring a constant dose. The coagulant mixes and reacts with the influent, forming a dense floc. The floc may be removed by gravitational setting in a clarifier tank or basin, or by filtration. Water from the clarifier tank, basin, or sand filters may be routed through cartridge(s) and/or bag filters for final polishing. Vendor-specific systems use various methods of dose control, sediment/floc removal, filtration, etc., that are detailed in project-specific documentation. The particular coagulant/flocculant to be used for a given project is determined based on the water chemistry of the site because the coagulants are specific in their reactions with various types of sediments. Appropriate selection of dosage must be carefully matched to the characteristics of each site.

ATS's are operated in two differing modes, either Batch or Flow-Through. Batch treatment can be defined as Pump-Treat-Hold-Test-Release. In Batch treatment, water is held in a basin or tank, and is not discharged until treatment is complete. Batch treatment involves holding or recirculating the treated water in a holding basin or tank(s) until treatment is complete or the basin or storage tank(s) is full. In Flow-Through treatment, water is pumped into the ATS directly from the runoff collection system or storm water holding pond, where it is treated and filtered as it flows through the system, and is then directly discharged. "Flow-Through Treatment" is also referred to as "Continuous Treatment."

1. Effluent Standards

This General Permit establishes NELs for discharges from construction sites that utilize an ATS. These systems lend themselves to NELs for turbidity and pH because of their known reliable treatment. Advanced systems have been in use in some form since the mid-1990s. An ATS is considered reliable, can consistently produce a discharge of less than 10 NTU, and has been used successfully at many sites in several states since 1995 to reduce turbidity to very low levels.¹⁹

This General Permit contains "compliance storm event" exceptions from the technology-based NELs for ATS discharges. The rationale is that technology-based requirements are developed assuming a certain design storm. In the case of ATS the industry-standard design storm is 10-year, 24-hour (as stated in

¹⁷ Romøen, K., B. Thu, and Ø. Evensen. 2002. Immersion delivery of plasmid DNA II. A study of the potentials of a chitosan based delivery system in rainbow trout (*Oncorhynchus mykiss*) fry. *Journal of Controlled Release* **85**: 215-225.

¹⁸ Bullock, G., V. Blazer, S. Tsukuda, and S. Summerfelt. 2000. Toxicity of acidified chitosan for cultured rainbow trout (*Oncorhynchus mykiss*). *Aquaculture* **185**:273-280.

¹⁹ Currier, B., G. Minton, R. Pitt, L. Roesner, K. Schiff, M. Stenstrom, E. Strassler, and E. Strecker. 2006. The Feasibility of Numeric Effluent Limits Applicable to Discharges of Storm Water Associated with Municipal, Industrial and Construction Activities.

Attachment F of this General Permit), so the compliance storm event has been established as the 10-year 24-hour event as well to provide consistency.

2. Training

Operator training is critical to the safe and efficient operation and maintenance of the ATS, and to ensure that all State Water Board monitoring and sampling requirements are met. The General Permit requires that all ATS operators have training specific to using ATS's liquid coagulants.

L. Post-Construction Requirements

Under past practices, new and redevelopment construction activities have resulted in modified natural watershed and stream processes. This is caused by altering the terrain, modifying the vegetation and soil characteristics, introducing impervious surfaces such as pavement and buildings, increasing drainage density through pipes and channels, and altering the condition of stream channels through straightening, deepening, and armoring. These changes result in a drainage system where sediment transport capacity is increased and sediment supply is decreased. A receiving channel's response is dependent on dominant channel materials and its stage of adjustment.

Construction activity can lead to impairment of beneficial uses in two main ways. First, during the actual construction process, storm water discharges can negatively affect the chemical, biological, and physical properties of downstream receiving waters. Due to the disturbance of the landscape, the most likely pollutant is sediment, however pH and other non-visible pollutants are also of great concern. Second, after most construction activities are completed at a construction site, the finished project may result in significant modification of the site's response to precipitation. New development and redevelopment projects have almost always resulted in permanent post-construction water quality impacts because more precipitation ends up as runoff and less precipitation is intercepted, evapotranspired, and infiltrated.

General Permit 99-08-DWQ required the SWPPP to include a description of all post-construction BMPs on a site and a maintenance schedule. An effective storm water management strategy must address the full suite of storm events (water quality, channel protection, overbank flood protection, extreme flood protection) (Figure 2).

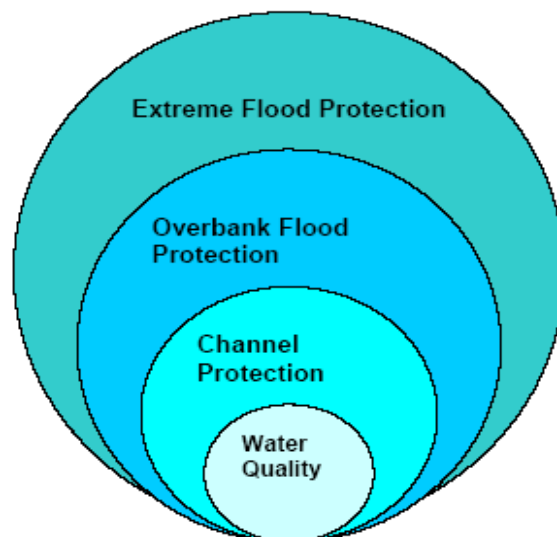

Figure 2 - Suite of Storm Events

The post-construction storm water performance standards in this General Permit specifically address water quality and channel protection events. Overbank flood protection and extreme flood protection events are traditionally dealt with in local drainage and flood protection ordinances. However, measures in this General Permit to address water quality and channel protection also reduce overbank and extreme flooding impacts. This General Permit aims to match post-construction runoff to pre-construction runoff for the 85th percentile storm event, which not only reduces the risk of impact to the receiving water's channel morphology but also provides some protection of water quality.

This General Permit clarifies that its runoff reduction requirements only apply to projects that lie outside of jurisdictions covered by a Standard Urban Storm water Management Plan (SUSMP) (or other more protective) post-construction requirements in either Phase I or Phase II permits.

Figures 3 and 4, below, show the General Permit enrollees (to Order 99-08-DWQ, as of March 10, 2008) overlaid upon a map with SUSMP (or more protective) areas in blue and purple. Areas without blue or purple indicate where the General Permit's runoff reduction requirements would actually apply.

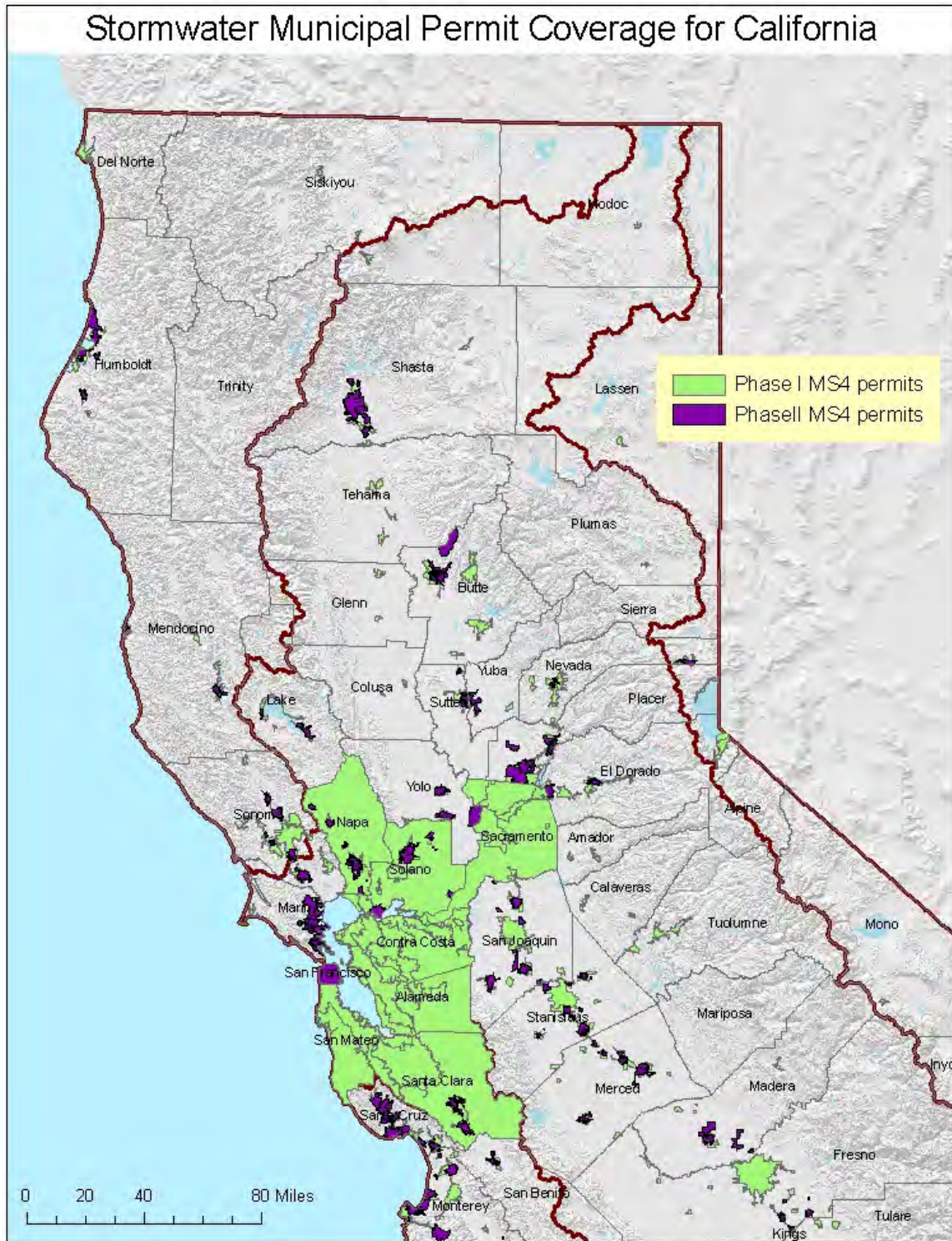

Figure 3 - Northern CA (2009) Counties / Cities With SUSMP-Plus Coverage



Figure 4 - Southern CA (2009) Counties / Cities With SUSMP-Plus Coverage

Water Quality:

This General Permit requires dischargers to replicate the pre-project runoff water balance (defined as the amount of rainfall that ends up as runoff) for the smallest storms up to the 85th percentile storm event, or the smallest storm event that generates runoff, whichever is larger. Contemporary storm water management generally routes these flows directly to the drainage system, increasing pollutant loads and potentially causing adverse effects on receiving waters. These smaller water quality events happen much more frequently than larger events and generate much higher pollutant loads on an annual basis. There are other adverse hydrological impacts that result from not designing according to the site's pre-construction water balance. In Maryland, Klein²⁰ noted that baseflow decreases as the extent of urbanization increases. Ferguson and Suckling²¹ noted a similar relation in watersheds in Georgia. On Long Island, Spinello and Simmons²² noted substantial decreases in base flow in intensely urbanized watersheds.

The permit emphasizes runoff reduction through on-site storm water reuse, interception, evapotranspiration and infiltration through non-structural controls and conservation design measures (e.g., downspout disconnection, soil quality preservation/enhancement, interceptor trees). Employing these measures close to the source of runoff generation is the easiest and most cost-effective way to comply with the pre-construction water balance standard. Using low-tech runoff reduction techniques close to the source is consistent with a number of recommendations in the literature.²³ In many cases, BMPs implemented close to the source of runoff generation cost less than end-of the pipe measures.²⁴ Dischargers are given the option of using Appendix 2 to calculate the required runoff volume or a watershed process-based, continuous simulation model such as the EPA's Storm Water Management Model (SWMM) or Hydrologic Simulation Program Fortran (HSPF). Such methods used by the discharger will be reviewed by the Regional Water Board upon NOT application.

Channel Protection:

In order to address channel protection, a basic understanding of fluvial geomorphic concepts is necessary. A dominant paradigm in fluvial geomorphology holds that streams adjust their channel dimensions (width and depth) in response to long-term changes in sediment supply and bankfull discharge (1.5 to 2 year recurrence interval). The bankfull stage corresponds to the discharge at which channel maintenance is the most effective, that is, the discharge at which the moving sediment, forming or removing bars, forming or changing bends and meanders, and generally doing work that results in the average morphologic characteristics of channels.²⁵ Lane (1955 as cited in Rosgen 1996²⁶) showed the generalized relationship between sediment load, sediment size, stream discharge and stream slope in

²⁰ Klein 1979 as cited in Delaware Department of Natural Resources (DDNR). 2004. Green Technology: The Delaware Urban Runoff Management Approach. Dover, DE. 117 pp.

²¹ Ferguson and Suckling 1990 as cited Delaware Department of Natural Resources (DDNR). 2004. Green Technology: The Delaware Urban Runoff Management Approach. Dover, DE. 117 pp.

²² Center for Watershed Protection (CWP). 2000. The Practice of Watershed Protection: Techniques for protecting our nation's streams, lakes, rivers, and estuaries. Ellicott City, MD. 741 pp.

²³ Bay Area Storm Water Management Agencies Association (BASMAA). 1997. Start at the Source: Residential Site Planning and Design Guidance Manual for Storm Water Quality Protection. Palo Alto, CA;

McCuen, R.H. 2003 Smart Growth: hydrologic perspective. Journal of Professional Issues in Engineering Education and Practice. Vol (129), pp.151-154;

Moglen, G.E. and S. Kim. 2007. Impervious imperviousness-are threshold based policies a good idea? Journal of the American Planning Association, Vol 73 No. 2. pp 161-171.

²⁴ Delaware Department of natural Resources (DDNR). 2004. Green technology: The Delaware urban Runoff Management Approach. Dover, DE. 117 pp.

²⁵ Dunne, T and L.B. Leopold. 1978. Water in Environmental Planning. San Francisco W.H. Freeman and Company

²⁶ Rosgen. D.L. 1996. Applied River Morphology. Pagosa Springs. Wildland Hydrology

Figure 5. A change in any one of these variables sets up a series of mutual adjustments in the companion variables with a resulting direct change in the physical characteristics of the stream channel.

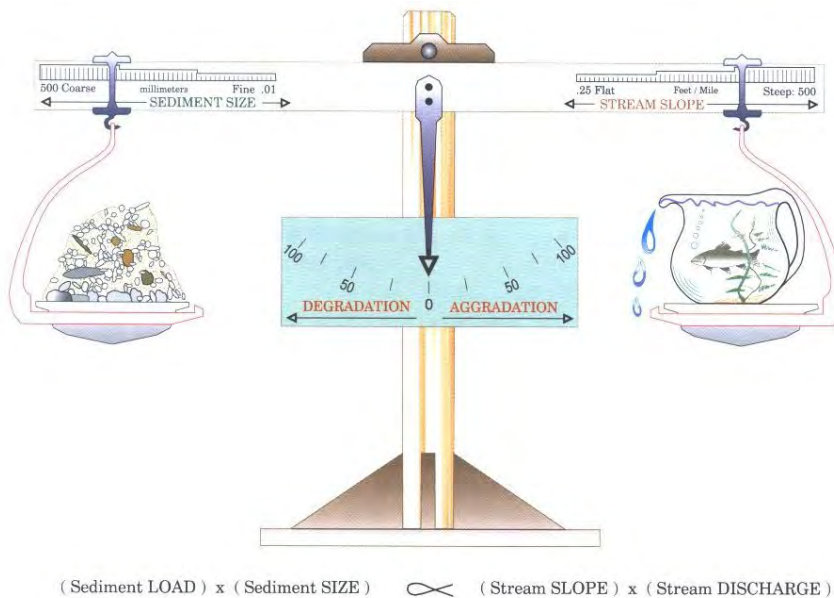

Figure 5 - Schematic of the Lane Relationship
After Lane (1955) as cited in Rosgen (1996)

Stream slope multiplied by stream discharge (the right side of the scale) is essentially an approximation of stream power, a unifying concept in fluvial geomorphology (Bledsoe 1999). Urbanization generally increases stream power and affects the resisting forces in a channel (sediment load and sediment size represented on the left side of the scale).

During construction, sediment loads can increase from 2 to 40,000 times over pre-construction levels.²⁷ Most of this sediment is delivered to stream channels during large, episodic rain events.²⁸ This increased sediment load leads to an initial aggradation phase where stream depths may decrease as sediment fills the channel, leading to a decrease in channel capacity and increase in flooding and overbank deposition. A degradation phase initiates after construction is completed.

Schumm et. al (1984) developed a channel evolution model that describes the series of adjustments from initial downcutting, to widening, to establishing new floodplains at lower elevations (Figure 6).

²⁷ Goldman S.J., K. Jackson, and T.A. Bursztynsky. 1986. Erosion and Sediment Control Handbook. McGraw Hill. San Francisco.

²⁸ Wolman 1967 as cited in Paul, M.P. and J.L. Meyer. 2001. Streams in the Urban Landscape. *Annu. Rev.Ecol. Syst.* 32: 333-365.

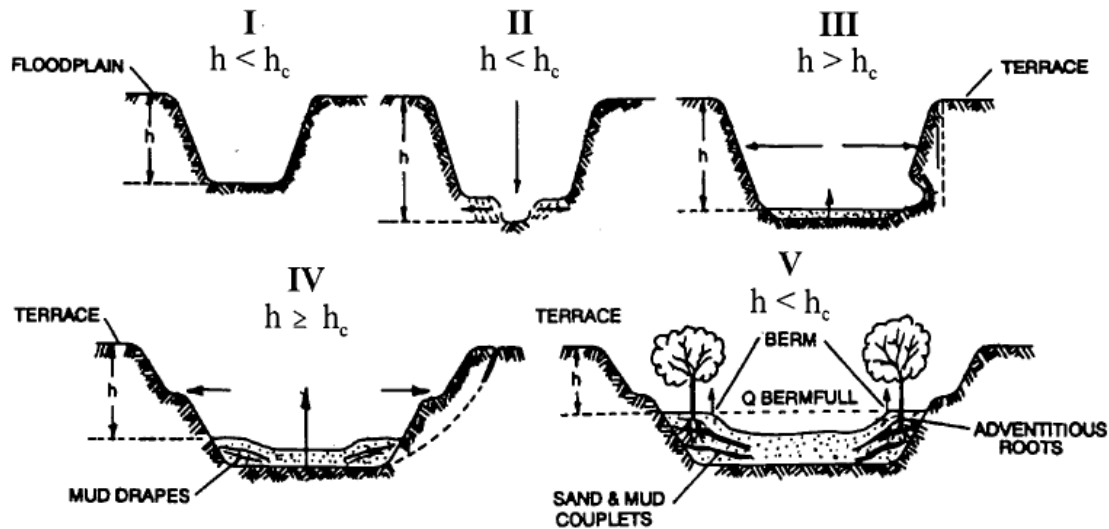

Figure 6 - Channel Changes Associated with Urbanization

After Incised Channel Evolution Sequence in Schumm et. al 1984

Channel incision (Stage II) and widening (Stages III and to a lesser degree, Stage IV) are due to a number of fundamental changes on the landscape. Connected impervious area and compaction of pervious surfaces increase the frequency and volume of bankfull discharges.²⁹ Increased drainage density (miles of stream length per square mile of watershed) also negatively impacts receiving stream channels.³⁰ Increased drainage density and hydraulic efficiency leads to an increase in the frequency and volume of bankfull discharges because the time of concentration is shortened. Flows from engineered pipes and channels are also often “sediment starved” and seek to replenish their sediment supply from the channel.

Encroachment of stream channels can also lead to an increase in stream slope, which leads to an increase in stream power. In addition, watershed sediment loads and sediment size (with size generally represented as the median bed and bank particle size, or d_{50}) decrease during urbanization.³¹ This means

²⁹ Booth, D. B. and C. R. Jackson. 1997. Urbanization of Aquatic Systems: Degradation Thresholds, Storm Water Detection, and the Limits of Mitigation. *Journal of the American Water Resources Association* Vol. 33, No.5, pp. 1077-1089.

³⁰ May, C.W. 1998. Cumulative effects of urbanization on small streams in the Puget Sound Lowland ecoregion. Conference proceedings from Puget Sound Research '98 held March 12, 13 1998 in Seattle, WA;

Santa Clara Valley Urban Runoff Pollution Prevention Program. 2002. Hydromodification Management Plan Literature Review. 80 pp.

³¹ Finkenbine, J.K., D.S. Atwater, and D.S. Mavinic. 2000. Stream health after urbanization. *J. Am. Water Resour. Assoc.* 36:1149-60;

that even if pre- and post-development stream power are the same, more erosion will occur in the post-development stage because the smaller particles are less resistant (provided they are non-cohesive).

As shown in Stages II and III, the channel deepens and widens to accommodate the increased stream power³² and decrease in sediment load and sediment size. Channels may actually narrow as entrained sediment from incision is deposited laterally in the channel. After incised channels begin to migrate laterally (Stage III), bank erosion begins, which leads to general channel widening.³³ At this point, a majority of the sediment that leaves a drainage area comes from within the channel, as opposed to the background and construction related hillslope contribution. Stage IV is characterized by more aggradation and localized bank instability. Stage V represents a new quasi-equilibrium channel morphology in balance with the new flow and sediment supply regime. In other words, stream power is in balance with sediment load and sediment size.

The magnitude of the channel morphology changes discussed above varies along a stream network as well as with the age of development, slope, geology (sand-bedded channels may cycle through the evolution sequence in a matter of decades whereas clay-dominated channels may take much longer), watershed sediment load and size, type of urbanization, and land use history. It is also dependent on a channel's stage in the channel evolution sequence when urbanization occurs. Management strategies

Pizzuto, J.E. W.S. Hession, and M. McBride. 2000. Comparing gravel-bed rivers in paired urban and rural catchments of southeastern Pennsylvania. *Geology* 28:79-82.

³² Hammer 1973 as cited in Delaware Department of Natural Resources (DDNR). 2004. Green Technology: The Delaware Urban Runoff Management Approach. Dover, DE. 117 pp;

Booth, D.B. 1990. Stream Channel Incision Following Drainage Basin Urbanization. *Water Resour. Bull.* 26:407-417.

³³ Trimble, S.W. 1997. Contribution of Stream Channel Erosion to Sediment Yield from an Urbanizing Watershed. *Science*: Vol. 278 (21), pp. 1442-1444.

must take into account a channel's stage of adjustment and account for future changes in the evolution of channel form (Stein and Zaleski 2005).³⁴

Traditional structural water quality BMPs (e.g. detention basins and other devices used to store volumes of runoff) unless they are highly engineered to provide adequate flow duration control, do not adequately protect receiving waters from accelerated channel bed and bank erosion, do not address post-development increases in runoff volume, and do not mitigate the decline in benthic macroinvertebrate communities in the receiving waters³⁵ suggest that structural BMPs are not as effective in protecting aquatic communities as a continuous riparian buffer of native vegetation. This is supported by the findings of Zucker and White³⁶, where instream biological metrics were correlated with the extent of forested buffers.

This General Permit requires dischargers to maintain pre-development drainage densities and times of concentration in order to protect channels and encourages dischargers to implement setbacks to reduce channel slope and velocity changes that can lead to aquatic habitat degradation.

There are a number of other approaches for modeling fluvial systems, including statistical and physical models and simpler stream power models.³⁷ The use of these models in California is described in Stein and Zaleski (2005).³⁸ Rather than prescribe a specific one-size-fits-all modeling method in this permit, the State Water Board intends to develop a stream power and channel evolution model-based framework to assess channels and develop a hierarchy of suitable analysis methods and management strategies. In time, this framework may become a State Water Board water quality control policy.

Permit Linkage to Overbank and Extreme Flood Protection

Site design BMPs (e.g. rooftop and impervious disconnection, vegetated swales, setbacks and buffers) filter and settle out pollutants and provide for more infiltration than is possible for traditional centralized structural BMPs placed at the lowest point in a site. They provide source control for runoff and lead to a reduction in pollutant loads. When implemented, they also help reduce the magnitude and volume of larger, less frequent storm events (e.g., 10-yr, 24-hour storm and larger), thereby reducing the need for expensive flood control infrastructure. Nonstructural BMPs can also be a landscape amenity, instead of a large isolated structure requiring substantial area for ancillary access, buffering, screening and maintenance facilities.²⁵ The multiple benefits of using non-structural benefits will be critically important as the state's population increases and imposes strains upon our existing water resources.

Maintaining predevelopment drainage densities and times of concentration will help reduce post-development peak flows and volumes in areas not covered under a municipal permit. The most effective way to preserve drainage areas and maximize time of concentration is to implement landform grading,

³⁴ Stein, E.S. and S. Zaleski. 2005. Managing runoff to protect natural stream: the latest developments on investigation and management of hydromodification in California. Southern California Coastal Water Research Project Technical Report 475. 26 pp.

³⁵ Horner, R.R. 2006. Investigation of the Feasibility and Benefits of Low-Impact Site Design Practices (LID) for the San Diego Region. Available at: http://www.projectcleanwater.org/pdf/permit/case-study_lid.pdf.

³⁶ Delaware Department of Natural Resources (DDNR). 2004. Green Technology: The Delaware Urban Runoff Management Approach. Dover, DE. 117 pp.

³⁷ Finlayson, D.P. and D.R. Montgomery. 2003. Modeling large-scale fluvial erosion in geographic information systems. *Geomorphology* (53), pp. 147-164.

³⁸ Stein, E.S. and S. Zaleski. 2005. Managing runoff to protect natural stream: the latest developments on investigation and management of hydromodification in California. Southern California Coastal Water Research Project Technical Report 475. 26 pp.

incorporate site design BMPs and implement distributed structural BMPs (e.g., bioretention cells, rain gardens, rain cisterns).

M. Storm Water Pollution Prevention Plans

USEPA's Construction General Permit requires that qualified personnel conduct inspections. USEPA defines qualified personnel as "a person knowledgeable in the principles and practice of erosion and sediment controls who possesses the skills to assess conditions at the construction site that could impact storm water quality and to assess the effectiveness of any sediment and erosion control measures selected to control the quality of storm water discharges from the construction activity."³⁹ USEPA also suggests that qualified personnel prepare SWPPPs and points to numerous states that require certified professionals to be on construction sites at all times. States that currently have certification programs are Washington, Georgia, Florida, Delaware, Maryland, and New Jersey. The Permit 99-08-DWQ did not require that qualified personnel prepare SWPPPs or conduct inspections. However, to ensure that water quality is being protected, this General Permit requires that all SWPPPs be written, amended, and certified by a Qualified SWPPP Developer. A Qualified SWPPP Developer must possess one of the eight certifications and or registrations specified in this General Permit and effective two years after the adoption date of this General Permit, must have attended a State Water Board-sponsored or approved Qualified SWPPP Developer training course. Table 9 provides an overview of the criteria used in determining qualified certification titles for a QSD and QSP.

39 US Environmental Protection Agency. Stormwater Pollution Prevention Plans for Construction Activities. <<http://cfpub.epa.gov/npdes/stormwater/swppp.cfm>> and <http://www.epa.gov/npdes/pubs/sw_swppp_guide.pdf>.

Table 9 - Qualified SWPPP Developer/ Qualified SWPPP Practitioner Certification Criteria

Certification/ Title	Registered By	QSD/QSP	Certification Criteria
Professional Civil Engineer	California	Both	1. Approval Process 2. Code of Ethics 3. Accountability 4. Pre-requisites
Professional Geologist or Engineering Geologist	California	Both	1. Approval Process 2. Code of Ethics 3. Accountability 4. Pre-requisites
Landscape Architect	California	Both	1. Approval Process 2. Code of Ethics 3. Accountability 4. Pre-requisites
Professional Hydrologist	American Institute of Hydrology	Both	1. Approval Process 2. Code of Ethics 3. Accountability 4. Pre-requisites
Certified Professional in Erosion and Sediment Control™ (CPESC)	Enviro Cert International Inc.	Both	1. Approval Process 2. Code of Ethics 3. Accountability 4. Pre-requisites 5. Continuing Education
Certified Inspector of Sediment and Erosion Control™ (CISEC)	Certified Inspector of Sediment and Erosion Control, Inc.	QSP	1. Approval Process 2. Code of Ethics 3. Accountability 4. Pre-requisites 5. Continuing Education
Certified Erosion, Sediment and Storm Water Inspector™ (CESSWI)	Enviro Cert International Inc.	QSP	1. Approval Process 2. Code of Ethics 3. Accountability 4. Pre-requisites 5. Continuing Education
Certified Professional in Storm Water Quality™ (CPSWQ)	Enviro Cert International Inc.	Both	1. Approval Process 2. Code of Ethics 3. Accountability 4. Pre-requisites 5. Continuing Education

The previous versions of the General Permit required development and implementation of a SWPPP as the primary compliance mechanism. The SWPPP has two major objectives: (1) to help identify the sources of sediment and other pollutants that affect the quality of storm water discharges; and (2) to describe and ensure the implementation of BMPs to reduce or eliminate sediment and other pollutants in storm water and non-storm water discharges. The SWPPP must include BMPs that address source control, BMPs that address pollutant control, and BMPs that address treatment control.

This General Permit shifts some of the measures that were covered by this general requirement to specific permit requirements, each individually enforceable as a permit term. This General Permit emphasizes the use of appropriately selected, correctly installed and maintained pollution reduction BMPs. This approach provides the flexibility necessary to establish BMPs that can effectively address source control of pollutants during changing construction activities. These specific requirements also improve both the clarity and the enforceability of the General Permit so that the dischargers understand, and the public can determine whether the discharges are in compliance with, permit requirements.

The SWPPP must be implemented at the appropriate level to protect water quality at all times throughout the life of the project. The SWPPP must remain on the site during construction activities, commencing with the initial mobilization and ending with the termination of coverage under the General Permit. For LUPs the discharger shall make the SWPPP available at the construction site during working hours while construction is occurring and shall be made available upon request by a State or Municipal inspector. When the original SWPPP is retained by a crewmember in a construction vehicle and is not currently at the construction site, current copies of the BMPs and map/drawing will be left with the field crew and the original SWPPP shall be made available via a request by radio or telephone. Once construction activities are complete, until stabilization is achieved, the SWPPP shall be available from the SWPPP contact listed in the PRDs

A SWPPP must be appropriate for the type and complexity of a project and will be developed and implemented to address project specific conditions. Some projects may have similarities or complexities, yet each project is unique in its progressive state that requires specific description and selection of BMPs needed to address all possible generated pollutants

N. Regional Water Board Authorities

Because this General Permit will be issued to thousands of construction sites across the State, the Regional Water Boards retain discretionary authority over certain issues that may arise from the discharges in their respective regions. This General Permit does not grant the Regional Water Boards any authority they do not otherwise have; rather, it merely emphasizes that the Regional Water Boards can take specific actions related to this General Permit. For example, the Regional Water Boards will be enforcing this General Permit and may need to adjust some requirements for a discharger based on the discharger's compliance history.



Linda S. Adams
Secretary for
Environmental Protection

State Water Resources Control Board



Arnold Schwarzenegger
Governor

Division of Water Quality

1001 I Street • Sacramento, California 95814 • (916) 341-5455
Mailing Address: P.O. Box 100 • Sacramento, California • 95812-0100
Fax (916) 341-5463 • <http://www.waterboards.ca.gov>

NATIONAL POLLUTANT DISCHARGE ELIMINATION SYSTEM (NPDES)
GENERAL PERMIT FOR
STORM WATER DISCHARGES
ASSOCIATED WITH CONSTRUCTION AND LAND DISTURBANCE
ACTIVITIES

ORDER NO. 2009-0009-DWQ
NPDES NO. **CAS000002**

This Order was adopted by the State Water Resources Control Board on:	September 2, 2009
This Order shall become effective on:	July 1, 2010
This Order shall expire on:	September 2, 2014

IT IS HEREBY ORDERED, that this Order supersedes Order No. 99-08-DWQ [as amended by Order No. 2010-0014-DWQ] except for enforcement purposes. The Discharger shall comply with the requirements in this Order to meet the provisions contained in Division 7 of the California Water Code (commencing with section 13000) and regulations adopted thereunder, and the provisions of the federal Clean Water Act and regulations and guidelines adopted thereunder.

I, Jeanine Townsend, Clerk to the Board, do hereby certify that this Order with all attachments is a full, true, and correct copy of an Order adopted by the State Water Resources Control Board, on September 2, 2009.

AYE: Vice Chair Frances Spivy-Weber
Board Member Arthur G. Baggett, Jr.
Board Member Tam M. Doduc

NAY: Chairman Charles R. Hoppin

ABSENT: None

ABSTAIN: None

Jeanine Townsend
Clerk to the Board



Linda S. Adams
Secretary for
Environmental Protection

State Water Resources Control Board



Arnold Schwarzenegger
Governor

Division of Water Quality

1001 I Street • Sacramento, California 95814 • (916) 341-5455
Mailing Address: P.O. Box 100 • Sacramento, California • 95812-0100
Fax (916) 341-5463 • <http://www.waterboards.ca.gov>

NATIONAL POLLUTANT DISCHARGE ELIMINATION SYSTEM (NPDES) GENERAL PERMIT FOR STORM WATER DISCHARGES ASSOCIATED WITH CONSTRUCTION AND LAND DISTURBANCE ACTIVITIES

**ORDER NO. 2010-0014-DWQ
NPDES NO. CAS000002**

Order No. 2009-0009-DWQ was adopted by the State Water Resources Control Board on:	September 2, 2009
Order No. 2009-0009-DWQ became effective on:	July 1, 2010
Order No. 2009-0009-DWQ shall expire on:	September 2, 2014
This Order, which amends Order No. 2009-0009-DWQ, was adopted by the State Water Resources Control Board on:	November 16, 2010
This Order shall become effective on:	February 14, 2011

IT IS HEREBY ORDERED that this Order amends Order No. 2009-0009-DWQ. Additions to Order No. 2009-0009-DWQ are reflected in [blue-underline](#) text and deletions are reflected in ~~red-strikeout~~ text.

IT IS FURTHER ORDERED that staff are directed to prepare and post a conformed copy of Order No. 2009-0009-DWQ incorporating the revisions made by this Order.

I, Jeanine Townsend, Clerk to the Board, do hereby certify that this Order with all attachments is a full, true, and correct copy of an Order adopted by the State Water Resources Control Board, on **November 16, 2010**.

AYE: Chairman Charles R. Hoppin
Vice Chair Frances Spivy-Weber
Board Member Arthur G. Baggett, Jr.
Board Member Tam M. Doduc

NAY: None

ABSENT: None

ABSTAIN: None

Jeanine Townsend
Clerk to the Board

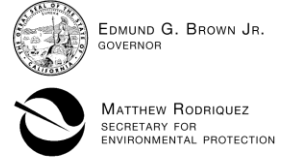

State Water Resources Control Board

NATIONAL POLLUTANT DISCHARGE ELIMINATION SYSTEM (NPDES)
GENERAL PERMIT FOR
STORM WATER DISCHARGES
ASSOCIATED WITH CONSTRUCTION AND LAND DISTURBANCE ACTIVITIES

ORDER NO. 2012-0006-DWQ
NPDES NO. CAS000002

Table with 2 columns: Description of order changes and Effective dates. Rows include adoption of 2009-0009-DWQ, effectiveness of 2009-0009-DWQ, effectiveness of 2010-0014-DWQ, expiration of 2009-0009-DWQ as amended, adoption of the current order, and effectiveness of the current order.

IT IS HEREBY ORDERED that this Order amends Order No. 2009-0009-DWQ. Additions to Order No. 2009-0009-DWQ are reflected in blue-underline text and deletions are reflected in red-strikeout text.

IT IS FURTHER ORDERED that staff are directed to prepare and post a conformed copy of Order No. 2009-000-DWQ incorporating the revisions made by this Order.

I, Jeanine Townsend, Clerk to the Board, do hereby certify that this Order with all attachments is a full, true, and correct copy of an Order adopted by the State Water Resources Control Board, on July 17, 2012.

AYE: Chairman Charles R. Hoppin
Vice Chair Frances Spivy-Weber
Board Member Tam M. Doduc
Board Member Steven Moore
Board Member Felicia Marcus

NAY: None

ABSENT: None

ABSTAIN: None

Handwritten signature of Jeanine Townsend
Jeanine Townsend
Clerk to the Board

TABLE OF CONTENTS

I.	FINDINGS	1
II.	CONDITIONS FOR PERMIT COVERAGE.....	14
III.	DISCHARGE PROHIBITIONS.....	20
IV.	SPECIAL PROVISIONS.....	22
V.	EFFLUENT STANDARDS & RECEIVING WATER MONITORING.....	28
VI.	RECEIVING WATER LIMITATIONS	31
VII.	TRAINING QUALIFICATIONS AND CERTIFICATION REQUIREMENTS.....	32
VIII.	RISK DETERMINATION	33
IX.	RISK LEVEL 1 REQUIREMENTS.....	34
X.	RISK LEVEL 2 REQUIREMENTS.....	34
XI.	RISK LEVEL 3 REQUIREMENTS.....	34
XII.	ACTIVE TREATMENT SYSTEMS (ATS).....	34
XIII.	POST-CONSTRUCTION STANDARDS	35
XIV.	SWPPP REQUIREMENTS	37
XV.	REGIONAL WATER BOARD AUTHORITIES.....	38
XVI.	ANNUAL REPORTING REQUIREMENTS.....	39

LIST OF ATTACHMENTS

Attachment A – Linear Underground/Overhead Requirements
Attachment A.1 – LUP Type Determination
Attachment A.2 – LUP Permit Registration Documents
Attachment B – Permit Registration Documents
Attachment C – Risk Level 1 Requirements
Attachment D – Risk Level 2 Requirements
Attachment E – Risk Level 3 Requirements
Attachment F – Active Treatment System (ATS) Requirements

LIST OF APPENDICES

Appendix 1 – Risk Determination Worksheet
Appendix 2 – Post-Construction Water Balance Performance Standard
Appendix 2.1 – Post-Construction Water Balance Performance Standard Spreadsheet
Appendix 3 – Bioassessment Monitoring Guidelines
Appendix 4 – Adopted/Implemented Sediment TMDLs
Appendix 5 – Glossary
Appendix 6 – Acronyms
Appendix 7 – State and Regional Water Resources Control Board Contacts

**STATE WATER RESOURCES CONTROL BOARD
ORDER NO. 2009-0009-DWQ
[AS AMENDED BY ORDER NO. 2010-0014-DWQ]
NATIONAL POLLUTANT DISCHARGE ELIMINATION SYSTEM
GENERAL PERMIT NO. CAS000002**

**WASTE DISCHARGE REQUIREMENTS
FOR
DISCHARGES OF STORM WATER RUNOFF ASSOCIATED WITH
CONSTRUCTION AND LAND DISTURBANCE ACTIVITIES**

I. FINDINGS

A. General Findings

The State Water Resources Control Board (State Water Board) finds that:

1. The federal Clean Water Act (CWA) prohibits certain discharges of storm water containing pollutants except in compliance with a National Pollutant Discharge Elimination System (NPDES) permit (Title 33 United States Code (U.S.C.) §§ 1311 and 1342(p); also referred to as Clean Water Act (CWA) §§ 301 and 402(p)). The U.S. Environmental Protection Agency (U.S. EPA) promulgates federal regulations to implement the CWA's mandate to control pollutants in storm water runoff discharges. (Title 40 Code of Federal Regulations (C.F.R.) Parts 122, 123, and 124). The federal statutes and regulations require discharges to surface waters comprised of storm water associated with construction activity, including demolition, clearing, grading, and excavation, and other land disturbance activities (except operations that result in disturbance of less than one acre of total land area and which are not part of a larger common plan of development or sale), to obtain coverage under an NPDES permit. The NPDES permit must require implementation of Best Available Technology Economically Achievable (BAT) and Best Conventional Pollutant Control Technology (BCT) to reduce or eliminate pollutants in storm water runoff. The NPDES permit must also include additional requirements necessary to implement applicable water quality standards.
2. This General Permit authorizes discharges of storm water associated with construction activity so long as the dischargers comply with all requirements, provisions, limitations and prohibitions in the permit. In addition, this General Permit regulates the discharges of storm water associated with construction activities from all Linear

Underground/Overhead Projects resulting in the disturbance of greater than or equal to one acre (Attachment A).

3. This General Permit regulates discharges of pollutants in storm water associated with construction activity (storm water discharges) to waters of the United States from construction sites that disturb one or more acres of land surface, or that are part of a common plan of development or sale that disturbs more than one acre of land surface.
4. This General Permit does not preempt or supersede the authority of local storm water management agencies to prohibit, restrict, or control storm water discharges to municipal separate storm sewer systems or other watercourses within their jurisdictions.
5. This action to adopt a general NPDES permit is exempt from the provisions of Chapter 3 of the California Environmental Quality Act (CEQA) (Public Resources Code Section 21100, et seq.), pursuant to Section 13389 of the California Water Code.
6. Pursuant to 40 C.F.R. § 131.12 and State Water Board [Resolution No. 68-16](#),¹ which incorporates the requirements of § 131.12 where applicable, the State Water Board finds that discharges in compliance with this General Permit will not result in the lowering of water quality standards, and are therefore consistent with those provisions. Compliance with this General Permit will result in improvements in water quality.
7. This General Permit serves as an NPDES permit in compliance with CWA § 402 and will take effect on July 1, 2010 by the State Water Board provided the Regional Administrator of the U.S. EPA has no objection. If the U.S. EPA Regional Administrator objects to its issuance, the General Permit will not become effective until such objection is withdrawn.
8. Following adoption and upon the effective date of this General Permit, the Regional Water Quality Control Boards (Regional Water Boards) shall enforce the provisions herein.
9. Regional Water Boards establish water quality standards in Basin Plans. The State Water Board establishes water quality standards in various statewide plans, including the California Ocean Plan. U.S. EPA establishes water quality standards in the National Toxic Rule (NTR) and the California Toxic Rule (CTR).

¹ Resolution No. 68-16 generally requires that existing water quality be maintained unless degradation is justified based on specific findings.

10. This General Permit does not authorize discharges of fill or dredged material regulated by the U.S. Army Corps of Engineers under CWA § 404 and does not constitute a waiver of water quality certification under CWA § 401.
11. The primary storm water pollutant at construction sites is excess sediment. Excess sediment can cloud the water, which reduces the amount of sunlight reaching aquatic plants, clog fish gills, smother aquatic habitat and spawning areas, and impede navigation in our waterways. Sediment also transports other pollutants such as nutrients, metals, and oils and greases.
12. Construction activities can impact a construction site's runoff sediment supply and transport characteristics. These modifications, which can occur both during and after the construction phase, are a significant cause of degradation of the beneficial uses established for water bodies in California. Dischargers can avoid these effects through better construction site design and activity practices.
13. This General Permit recognizes four distinct phases of construction activities. The phases are Grading and Land Development Phase, Streets and Utilities Phase, Vertical Construction Phase, and Final Landscaping and Site Stabilization Phase. Each phase has activities that can result in different water quality effects from different water quality pollutants. This General Permit also recognizes inactive construction as a category of construction site type.
14. Compliance with any specific limits or requirements contained in this General Permit does not constitute compliance with any other applicable requirements.
15. Following public notice in accordance with State and Federal laws and regulations, the State Water Board heard and considered all comments and testimony in a public hearing on 06/03/2009. The State Water Board has prepared written responses to all significant comments.
16. Construction activities obtaining coverage under the General Permit may have multiple discharges subject to requirements that are specific to general, linear, and/or active treatment system discharge types.
17. The State Water Board may reopen the permit if the U.S. EPA adopts a final effluent limitation guideline for construction activities.

B. Activities Covered Under the General Permit

18. Any construction or demolition activity, including, but not limited to, clearing, grading, grubbing, or excavation, or any other activity that results in a land disturbance of equal to or greater than one acre.
19. Construction activity that results in land surface disturbances of less than one acre if the construction activity is part of a larger common plan of development or the sale of one or more acres of disturbed land surface.
20. Construction activity related to residential, commercial, or industrial development on lands currently used for agriculture including, but not limited to, the construction of buildings related to agriculture that are considered industrial pursuant to U.S. EPA regulations, such as dairy barns or food processing facilities.
21. Construction activity associated with Linear Underground/Overhead Utility Projects (LUPs) including, but not limited to, those activities necessary for the installation of underground and overhead linear facilities (e.g., conduits, substructures, pipelines, towers, poles, cables, wires, connectors, switching, regulating and transforming equipment and associated ancillary facilities) and include, but are not limited to, underground utility mark-out, potholing, concrete and asphalt cutting and removal, trenching, excavation, boring and drilling, access road and pole/tower pad and cable/wire pull station, substation construction, substructure installation, construction of tower footings and/or foundations, pole and tower installations, pipeline installations, welding, concrete and/or pavement repair or replacement, and stockpile/borrow locations.
22. Discharges of sediment from construction activities associated with oil and gas exploration, production, processing, or treatment operations or transmission facilities.²
23. Storm water discharges from dredge spoil placement that occur outside of U.S. Army Corps of Engineers jurisdiction (upland sites) and that disturb one or more acres of land surface from construction activity are covered by this General Permit. Construction sites that intend to disturb one or more acres of land within the jurisdictional boundaries of

² Pursuant to the Ninth Circuit Court of Appeals' decision in *NRDC v. EPA* (9th Cir. 2008) 526 F.3d 591, and subsequent denial of the U.S. EPA's petition for reconsideration in November 2008, oil and gas construction activities discharging storm water contaminated only with sediment are no longer exempt from the NPDES program.

a CWA § 404 permit should contact the appropriate Regional Water Board to determine whether this permit applies to the site.

C. Activities Not Covered Under the General Permit

24. Routine maintenance to maintain original line and grade, hydraulic capacity, or original purpose of the facility.
25. Disturbances to land surfaces solely related to agricultural operations such as disking, harrowing, terracing and leveling, and soil preparation.
26. Discharges of storm water from areas on tribal lands; construction on tribal lands is regulated by a federal permit.
27. Construction activity and land disturbance involving discharges of storm water within the Lake Tahoe Hydrologic Unit. The Lahontan Regional Water Board has adopted its own permit to regulate storm water discharges from construction activity in the Lake Tahoe Hydrologic Unit (Regional Water Board 6SLT). Owners of construction sites in this watershed must apply for the Lahontan Regional Water Board permit rather than the statewide Construction General Permit.
28. Construction activity that disturbs less than one acre of land surface, and that is not part of a larger common plan of development or the sale of one or more acres of disturbed land surface.
29. Construction activity covered by an individual NPDES Permit for storm water discharges.
30. Discharges from small (1 to 5 acre) construction activities with an approved Rainfall Erosivity Waiver authorized by U.S. EPA Phase II regulations certifying to the State Board that small construction activity will occur only when the Rainfall Erosivity Factor is less than 5 ("R" in the Revised Universal Soil Loss Equation).
31. Landfill construction activity that is subject to the Industrial General Permit.
32. Construction activity that discharges to Combined Sewer Systems.
33. Conveyances that discharge storm water runoff combined with municipal sewage.
34. Discharges of storm water identified in CWA § 402(l)(2), 33 U.S.C. § 1342(l)(2).

35. Discharges occurring in basins that are not tributary or hydrologically connected to waters of the United States (for more information contact your Regional Water Board).

D. Obtaining and Modifying General Permit Coverage

36. This General Permit requires all dischargers to electronically file all Permit Registration Documents (PRDs), Notices of Termination (NOT), changes of information, annual reporting, and other compliance documents required by this General Permit through the State Water Board's Storm water Multi-Application and Report Tracking System (SMARTS) website.
37. Any information provided to the Regional Water Board shall comply with the Homeland Security Act and any other federal law that concerns security in the United States; any information that does not comply should not be submitted.
38. This General Permit grants an exception from the Risk Determination requirements for existing sites covered under Water Quality Orders No. 99-08-DWQ, and [No. 2003-0007-DWQ](#). For certain sites, adding additional requirements may not be cost effective. Construction sites covered under Water Quality Order No. 99-08-DWQ shall obtain permit coverage at the Risk Level 1. LUPs covered under Water Quality Order No. 2003-0007-DWQ shall obtain permit coverage as a Type 1 LUP. The Regional Water Boards have the authority to require Risk Determination to be performed on sites currently covered under Water Quality Orders No. 99-08-DWQ and No. 2003-0007-DWQ where they deem it necessary. The State Water Board finds that there are two circumstances when it may be appropriate for the Regional Water Boards to require a discharger that had filed an NOI under State Water Board Order No. 99-08-DWQ to recalculate the site's risk level. These circumstances are: (1) when the discharger has a demonstrated history of noncompliance with State Water Board Order No. 99-08-DWQ or; (2) when the discharger's site poses a significant risk of causing or contributing to an exceedance of a water quality standard without the implementation of the additional Risk Level 2 or 3 requirements.

E. Prohibitions

39. All discharges are prohibited except for the storm water and non-storm water discharges specifically authorized by this General Permit or another NPDES permit. Non-storm water discharges include a wide variety of sources, including improper dumping, spills, or leakage from storage tanks or transfer areas. Non-storm water discharges may

contribute significant pollutant loads to receiving waters. Measures to control spills, leakage, and dumping, and to prevent illicit connections during construction must be addressed through structural as well as non-structural Best Management Practices (BMPs)³. The State Water Board recognizes, however, that certain non-storm water discharges may be necessary for the completion of construction.

40. This General Permit prohibits all discharges which contain a hazardous substance in excess of reportable quantities established in 40 C.F.R. §§ 117.3 and 302.4, unless a separate NPDES Permit has been issued to regulate those discharges.
41. This General Permit incorporates discharge prohibitions contained in water quality control plans, as implemented by the State Water Board and the nine Regional Water Boards.
42. Pursuant to the Ocean Plan, discharges to Areas of Special Biological Significance (ASBS) are prohibited unless covered by an exception that the State Water Board has approved.
43. This General Permit prohibits the discharge of any debris⁴ from construction sites. Plastic and other trash materials can cause negative impacts to receiving water beneficial uses. The State Water Board encourages the use of more environmentally safe, biodegradable materials on construction sites to minimize the potential risk to water quality.

F. Training

44. In order to improve compliance with and to maintain consistent enforcement of this General Permit, all dischargers are required to appoint two positions - the Qualified SWPPP Developer (QSD) and the Qualified SWPPP Practitioner (QSP) - who must obtain appropriate training. Together with the key stakeholders, the State and Regional Water Boards are leading the development of this curriculum through a collaborative organization called The Construction General Permit (CGP) Training Team.
45. The Professional Engineers Act (Bus. & Prof. Code section 6700, et seq.) requires that all engineering work must be performed by a California licensed engineer.

³ BMPs are scheduling of activities, prohibitions of practices, maintenance procedures, and other management practices to prevent or reduce the discharge of pollutants to waters of the United States. BMPs also include treatment requirements, operating procedures, and practice to control site runoff, spillage or leaks, sludge or waste disposal, or drainage from raw material storage.

⁴ Litter, rubble, discarded refuse, and remains of destroyed inorganic anthropogenic waste.

G. Determining and Reducing Risk

46. The risk of accelerated erosion and sedimentation from wind and water depends on a number of factors, including proximity to receiving water bodies, climate, topography, and soil type.
47. This General Permit requires dischargers to assess the risk level of a site based on both sediment transport and receiving water risk. This General Permit contains requirements for Risk Levels 1, 2 and 3, and LUP Risk Type 1, 2, and 3 (Attachment A). Risk levels are established by determining two factors: first, calculating the site's sediment risk; and second, receiving water risk during periods of soil exposure (i.e. grading and site stabilization). Both factors are used to determine the site-specific Risk Level(s). LUPs can be determined to be Type 1 based on the flowchart in Attachment A.1.
48. Although this General Permit does not mandate specific setback distances, dischargers are encouraged to set back their construction activities from streams and wetlands whenever feasible to reduce the risk of impacting water quality (e.g., natural stream stability and habitat function). Because there is a reduced risk to receiving waters when setbacks are used, this General Permit gives credit to setbacks in the risk determination and post-construction storm water performance standards. The risk calculation and runoff reduction mechanisms in this General Permit are expected to facilitate compliance with any Regional Water Board and local agency setback requirements, and to encourage voluntary setbacks wherever practicable.
49. Rain events can occur at any time of the year in California. Therefore, a Rain Event Action Plan (REAP) is necessary for Risk Level 2 and 3 traditional construction projects (LUPs exempt) to ensure that active construction sites have adequate erosion and sediment controls implemented prior to the onset of a storm event, even if construction is planned only during the dry season.
50. Soil particles smaller than 0.02 millimeters (mm) (i.e., finer than medium silt) do not settle easily using conventional measures for sediment control (i.e., sediment basins). Given their long settling time, dislodging these soils results in a significant risk that fine particles will be released into surface waters and cause unacceptable downstream impacts. If operated correctly, an Active Treatment System (ATS⁵) can prevent or reduce the release of fine particles from construction sites.

⁵ An ATS is a treatment system that employs chemical coagulation, chemical flocculation, or electro coagulation in order to reduce turbidity caused by fine suspended sediment.

Use of an ATS can effectively reduce a site's risk of impacting receiving waters.

51. Dischargers located in a watershed area where a Total Maximum Daily Load (TMDL) has been adopted or approved by the Regional Water Board or U.S. EPA may be required by a separate Regional Water Board action to implement additional BMPs, conduct additional monitoring activities, and/or comply with an applicable waste load allocation and implementation schedule. Such dischargers may also be required to obtain an individual Regional Water Board permit specific to the area.

H. Effluent Standards

52. The State Water Board convened a blue ribbon panel of storm water experts that submitted a report entitled, "The Feasibility of Numeric Effluent Limits Applicable to Discharges of Storm Water Associated with Municipal, Industrial and Construction Activities," dated June 19, 2006. The panel concluded that numeric limits or action levels are technically feasible to control construction storm water discharges, provided that certain conditions are considered. The panel also concluded that numeric effluent limitations (NELs) are feasible for discharges from construction sites that utilize an ATS. The State Water Board has incorporated the expert panel's suggestions into this General Permit, which includes numeric action levels (NALs) for pH and turbidity, and special numeric limits for ATS discharges.

Determining Compliance with Numeric Limitations

53. This General Permit sets a pH NAL of 6.5 to 8.5, and a turbidity NAL of 250 NTU. The purpose of the NAL and its associated monitoring requirement is to provide operational information regarding the performance of the measures used at the site to minimize the discharge of pollutants and to protect beneficial uses and receiving waters from the adverse effects of construction-related storm water discharges. An exceedance of a NAL does not constitute a violation of this General Permit.
54. This General Permit requires dischargers with NAL exceedances to immediately implement additional BMPs and revise their Storm Water Pollution Prevention Plans (SWPPPs) accordingly to either prevent pollutants and authorized non-storm water discharges from contaminating storm water, or to substantially reduce the pollutants to levels consistently below the NALs. NAL exceedances are reported in the State Water Boards SMARTS system, and the discharger is

required to provide an NAL Exceedance Report when requested by a Regional Water Board.

I. Receiving Water Limitations

55. This General Permit requires all enrolled dischargers to determine the receiving waters potentially affected by their discharges and to comply with all applicable water quality standards, including any more stringent standards applicable to a water body.

J. Sampling, Monitoring, Reporting and Record Keeping

56. Visual monitoring of storm water and non-storm water discharges is required for all sites subject to this General Permit.

57. Records of all visual monitoring inspections are required to remain on-site during the construction period and for a minimum of three years.

58. For all Risk Level 3/LUP Type 3 and Risk Level 2/LUP Type 2 sites, this General Permit requires effluent monitoring for pH and turbidity. Sampling, analysis and monitoring requirements for effluent monitoring for pH and turbidity are contained in this General Permit.

59. Risk Level 3 and LUP Type 3 sites with effluent that exceeds the Receiving Water Monitoring Triggers contained in this General Permit and with direct discharges to receiving water are required to conduct receiving water monitoring. An exceedance of a Receiving Water Monitoring Trigger does not constitute a violation of this General Permit.

60. This General Permit establishes a 5 year, 24 hour (expressed in inches of rainfall) as an exemptions to the receiving water monitoring requirements for Risk Level 3 and LUP Type 3 dischargers.

61. If run-on is caused by a forest fire or any other natural disaster, then receiving water monitoring triggers do not apply.

62. For Risk Level 3 and LUP Type 3 sites larger than 30 acres and with direct discharges to receiving waters, this General Permit requires bioassessment sampling before and after site completion to determine if significant degradation to the receiving water's biota has occurred. Bioassessment sampling guidelines are contained in this General Permit.

63. A summary and evaluation of the sampling and analysis results will be submitted in the Annual Reports.
64. This General Permit contains sampling, analysis and monitoring requirements for non-visible pollutants at all sites subject to this General Permit.
65. Compliance with the General Permit relies upon dischargers to electronically self-report any discharge violations and to comply with any Regional Water Board enforcement actions.
66. This General Permit requires that all dischargers maintain a paper or electronic copy of all required records for three years from the date generated or date submitted, whichever is last. These records must be available at the construction site until construction is completed. For LUPs, these documents may be retained in a crew member's vehicle and made available upon request.

K. Active Treatment System (ATS) Requirements

67. Active treatment systems add chemicals to facilitate flocculation, coagulation and filtration of suspended sediment particles. The uncontrolled release of these chemicals to the environment can negatively affect the beneficial uses of receiving waters and/or degrade water quality (e.g., acute and chronic toxicity). Additionally, the batch storage and treatment of storm water through an ATS' can potentially cause physical impacts on receiving waters if storage volume is inadequate or due to sudden releases of the ATS batches and improperly designed outfalls.
68. If designed, operated and maintained properly an ATS can achieve very high removal rates of suspended sediment (measured as turbidity), albeit at sometimes significantly higher costs than traditional erosion/sediment control practices. As a result, this General Permit establishes NELs consistent with the expected level of typical ATS performance.
69. This General Permit requires discharges of storm water associated with construction activity that undergo active treatment to comply with special operational and effluent limitations to ensure that these discharges do not adversely affect the beneficial uses of the receiving waters or cause degradation of their water quality.
70. For ATS discharges, this General Permit establishes technology-based NELs for turbidity.

71. This General Permit establishes a 10 year, 24 hour (expressed in inches of rainfall) Compliance Storm Event exemption from the technology-based numeric effluent limitations for ATS discharges. Exceedances of the ATS turbidity NEL constitutes a violation of this General Permit.

L. Post-Construction Requirements

72. This General Permit includes performance standards for post-construction that are consistent with State Water Board [Resolution No. 2005-0006](#), "Resolution Adopting the Concept of Sustainability as a Core Value for State Water Board Programs and Directing Its Incorporation," and [2008-0030](#), "Requiring Sustainable Water Resources Management." The requirement for all construction sites to match pre-project hydrology will help ensure that the physical and biological integrity of aquatic ecosystems are sustained. This "runoff reduction" approach is analogous in principle to Low Impact Development (LID) and will serve to protect related watersheds and waterbodies from both hydrologic-based and pollution impacts associated with the post-construction landscape.
73. LUP projects are not subject to post-construction requirements due to the nature of their construction to return project sites to pre-construction conditions.

M. Storm Water Pollution Prevention Plan Requirements

74. This General Permit requires the development of a site-specific SWPPP. The SWPPP must include the information needed to demonstrate compliance with all requirements of this General Permit, and must be kept on the construction site and be available for review. The discharger shall ensure that a QSD develops the SWPPP.
75. To ensure proper site oversight, this General Permit requires a Qualified SWPPP Practitioner to oversee implementation of the BMPs required to comply with this General Permit.

N. Regional Water Board Authorities

76. Regional Water Boards are responsible for implementation and enforcement of this General Permit. A general approach to permitting is not always suitable for every construction site and environmental circumstances. Therefore, this General Permit recognizes that Regional Water Boards must have some flexibility and authority to alter, approve, exempt, or rescind permit authority granted under this

General Permit in order to protect the beneficial uses of our receiving waters and prevent degradation of water quality.

IT IS HEREBY ORDERED that all dischargers subject to this General Permit shall comply with the following conditions and requirements (including all conditions and requirements as set forth in Attachments A, B, C, D, E and F)⁶:

II. CONDITIONS FOR PERMIT COVERAGE

A. Linear Underground/Overhead Projects (LUPs)

1. Linear Underground/Overhead Projects (LUPs) include, but are not limited to, any conveyance, pipe, or pipeline for the transportation of any gaseous, liquid (including water and wastewater for domestic municipal services), liquescent, or slurry substance; any cable line or wire for the transmission of electrical energy; any cable line or wire for communications (e.g. telephone, telegraph, radio or television messages); and associated ancillary facilities. Construction activities associated with LUPs include, but are not limited to, (a) those activities necessary for the installation of underground and overhead linear facilities (e.g., conduits, substructures, pipelines, towers, poles, cables, wires, connectors, switching, regulating and transforming equipment, and associated ancillary facilities); and include, but are not limited to, (b) underground utility mark-out, potholing, concrete and asphalt cutting and removal, trenching, excavation, boring and drilling, access road and pole/tower pad and cable/wire pull station, substation construction, substructure installation, construction of tower footings and/or foundations, pole and tower installations, pipeline installations, welding, concrete and/ or pavement repair or replacement, and stockpile/borrow locations.
2. The Legally Responsible Person is responsible for obtaining coverage under the General Permit where the construction of pipelines, utility lines, fiber-optic cables, or other linear underground/overhead projects will occur across several properties unless the LUP construction activities are covered under another construction storm water permit.
3. Only LUPs shall comply with the conditions and requirements in Attachment A, A.1 & A.2 of this Order. The balance of this Order is not applicable to LUPs except as indicated in Attachment A.

⁶ These attachments are part of the General Permit itself and are not separate documents that are capable of being updated independently by the State Water Board.

B. Obtaining Permit Coverage Traditional Construction Sites

1. The Legally Responsible Person (LRP) (see Special Provisions, Electronic Signature and Certification Requirements, Section IV.I.1) must obtain coverage under this General Permit.
2. To obtain coverage, the LRP must electronically file Permit Registration Documents (PRDs) prior to the commencement of construction activity. Failure to obtain coverage under this General Permit for storm water discharges to waters of the United States is a violation of the CWA and the California Water Code.
3. PRDs shall consist of:
 - a. Notice of Intent (NOI)
 - b. Risk Assessment (Section VIII)
 - c. Site Map
 - d. Storm Water Pollution Prevention Plan (Section XIV)
 - e. Annual Fee
 - f. Signed Certification Statement

Any information provided to the Regional Water Board shall comply with the Homeland Security Act and any other federal law that concerns security in the United States; any information that does not comply should not be submitted.

Attachment B contains additional PRD information. Dischargers must electronically file the PRDs, and mail the appropriate annual fee to the State Water Board.

4. This permit is effective on July 1, 2010.
 - a. **Dischargers Obtaining Coverage On or After July 1, 2010:** All dischargers requiring coverage on or after July 1, 2010, shall electronically file their PRDs prior to the commencement of construction activities, and mail the appropriate annual fee no later than seven days prior to the commencement of construction activities. Permit coverage shall not commence until the PRDs and the annual fee are received by the State Water Board, and a WDID number is assigned and sent by SMARTS.
 - b. **Dischargers Covered Under 99-08-DWQ and 2003-0007-DWQ:** Existing dischargers subject to State Water Board Order No. 99-08-DWQ (existing dischargers) will continue coverage under 99-08-DWQ until July 1, 2010. After July 1, 2010, all NOIs subject to State Water Board Order No. 99-08-DWQ will be terminated.

Existing dischargers shall electronically file their PRDs no later than July 1, 2010. If an existing discharger's site acreage subject to the annual fee has changed, it shall mail a revised annual fee no less than seven days after receiving the revised annual fee notification, **or else lose permit coverage**. All existing dischargers shall be exempt from the risk determination requirements in Section VIII of this General Permit until two years after permit adoption. All existing dischargers are therefore subject to Risk Level 1 requirements regardless of their site's sediment and receiving water risks. However, a Regional Board retains the authority to require an existing discharger to comply with the Section VIII risk determination requirements.

5. The discharger is only considered covered by this General Permit upon receipt of a Waste Discharger Identification (WDID) number assigned and sent by the State Water Board Storm water Multi-Application and Report Tracking System (SMARTS). In order to demonstrate compliance with this General Permit, the discharger must obtain a WDID number and must present documentation of a valid WDID upon demand.
6. During the period this permit is subject to review by the U.S. EPA, the prior permit (State Water Board Order No. 99-08-DWQ) remains in effect. Existing dischargers under the prior permit will continue to have coverage under State Water Board Order No. 99-08-DWQ until this General Permit takes effect on July 1, 2010. Dischargers who complete their projects and electronically file an NOT prior to July 1, 2010, are not required to obtain coverage under this General Permit.
7. Small Construction Rainfall Erosivity Waiver

EPA's Small Construction Erosivity Waiver applies to sites between one and five acres demonstrating that there are no adverse water quality impacts.

Dischargers eligible for a Rainfall Erosivity Waiver based on low erosivity potential shall complete the electronic Notice of Intent (NOI) and Sediment Risk form through the State Water Board's SMARTS system, certifying that the construction activity will take place during a period when the value of the rainfall erosivity factor is less than five. Where the LRP changes or another LRP is added during construction, the new LRP must also submit a waiver certification through the SMARTS system.

If a small construction site continues beyond the projected completion date given on the waiver certification, the LRP shall recalculate the

rainfall erosivity factor for the new project duration and submit this information through the SMARTS system. If the new R factor is below five (5), the discharger shall update through SMARTS all applicable information on the waiver certification and retain a copy of the revised waiver onsite. The LRP shall submit the new waiver certification 30 days prior to the projected completion date listed on the original waiver form to assure exemption from permitting requirements is uninterrupted. If the new R factor is five (5) or above, the LRP shall be required to apply for coverage under this Order.

8. In the case of a public emergency that requires immediate construction activities, a discharger shall submit a brief description of the emergency construction activity within five days of the onset of construction, and then shall submit all PRDs within thirty days.

C. Revising Permit Coverage for Change of Acreage or New Ownership

1. The discharger may reduce or increase the total acreage covered under this General Permit when a portion of the site is complete and/or conditions for termination of coverage have been met (See Section II.D Conditions for Termination of Coverage); when ownership of a portion of the site is sold to a different entity; or when new acreage, subject to this General Permit, is added to the site.
2. Within 30 days of a reduction or increase in total disturbed acreage, the discharger shall electronically file revisions to the PRDs that include:
 - a. A revised NOI indicating the new project size;
 - b. A revised site map showing the acreage of the site completed, acreage currently under construction, acreage sold/transferred or added, and acreage currently stabilized in accordance with the Conditions for Termination of Coverage in Section II.D below.
 - c. SWPPP revisions, as appropriate; and
 - d. Certification that any new landowners have been notified of applicable requirements to obtain General Permit coverage. The certification shall include the name, address, telephone number, and e-mail address of the new landowner.
 - e. If the project acreage has increased, dischargers shall mail payment of revised annual fees within 14 days of receiving the revised annual fee notification.

3. The discharger shall continue coverage under the General Permit for any parcel that has not achieved “Final Stabilization” as defined in Section II.D.
4. When an LRP with active General Permit coverage transfers its LRP status to another person or entity that qualifies as an LRP, the existing LRP shall inform the new LRP of the General Permit’s requirements. In order for the new LRP to continue the construction activity on its parcel of property, the new LRP, or the new LRP’s approved signatory, must submit PRDs in accordance with this General Permit’s requirements.

D. Conditions for Termination of Coverage

1. Within 90 days of when construction is complete or ownership has been transferred, the discharger shall electronically file a Notice of Termination (NOT), a final site map, and photos through the State Water Boards SMARTS system. Filing a NOT certifies that all General Permit requirements have been met. The Regional Water Board will consider a construction site complete only when all portions of the site have been transferred to a new owner, or all of the following conditions have been met:
 - a. For purposes of “final stabilization,” the site will not pose any additional sediment discharge risk than it did prior to the commencement of construction activity;
 - b. There is no potential for construction-related storm water pollutants to be discharged into site runoff;
 - c. Final stabilization has been reached;
 - d. Construction materials and wastes have been disposed of properly;
 - e. Compliance with the Post-Construction Standards in Section XIII of this General Permit has been demonstrated;
 - f. Post-construction storm water management measures have been installed and a long-term maintenance plan⁷ has been established; and
 - g. All construction-related equipment, materials and any temporary BMPs no longer needed are removed from the site.

⁷ For the purposes of this requirement a long-term maintenance plan will be designed for a minimum of five years, and will describe the procedures to ensure that the post-construction storm water management measures are adequately maintained.

2. The discharger shall certify that final stabilization conditions are satisfied in their NOT. Failure to certify shall result in continuation of permit coverage and annual billing.
3. The NOT must demonstrate through photos, RUSLE or RUSLE2, or results of testing and analysis that the site meets all of the conditions above (Section II.D.1) and the final stabilization condition (Section II.D.1.a) is attained by one of the following methods:

- a. "70% final cover method," no computational proof required

OR:

- b. "RUSLE or RUSLE2 method," computational proof required

OR:

- c. "Custom method", the discharger shall demonstrate in some other manner than a or b, above, that the site complies with the "final stabilization" requirement in Section II.D.1.a.

III. DISCHARGE PROHIBITIONS

- A.** Dischargers shall not violate any discharge prohibitions contained in applicable Basin Plans or statewide water quality control plans. Waste discharges to Areas of Special Biological Significance (ASBS) are prohibited by the California Ocean Plan, unless granted an exception issued by the State Water Board.
- B.** All discharges are prohibited except for the storm water and non-storm water discharges specifically authorized by this General Permit or another NPDES permit.
- C.** Authorized non-storm water discharges may include those from de-chlorinated potable water sources such as: fire hydrant flushing, irrigation of vegetative erosion control measures, pipe flushing and testing, water to control dust, uncontaminated ground water from dewatering, and other discharges not subject to a separate general NPDES permit adopted by a Regional Water Board. The discharge of non-storm water is authorized under the following conditions:
1. The discharge does not cause or contribute to a violation of any water quality standard;
 2. The discharge does not violate any other provision of this General Permit;
 3. The discharge is not prohibited by the applicable Basin Plan;
 4. The discharger has included and implemented specific BMPs required by this General Permit to prevent or reduce the contact of the non-storm water discharge with construction materials or equipment.
 5. The discharge does not contain toxic constituents in toxic amounts or (other) significant quantities of pollutants;
 6. The discharge is monitored and meets the applicable NALs; and
 7. The discharger reports the sampling information in the Annual Report.

If any of the above conditions are not satisfied, the discharge is not authorized by this General Permit. The discharger shall notify the Regional Water Board of any anticipated non-storm water discharges not already authorized by this General Permit or another NPDES permit, to determine whether a separate NPDES permit is necessary.

- D.** Debris resulting from construction activities are prohibited from being discharged from construction sites.
- E.** When soil contamination is found or suspected and a responsible party is not identified, or the responsible party fails to promptly take the appropriate action, the discharger shall have those soils sampled and tested to ensure proper handling and public safety measures are implemented. The discharger shall notify the appropriate local, State, and federal agency(ies) when contaminated soil is found at a construction site, and will notify the appropriate Regional Water Board.

IV. SPECIAL PROVISIONS

A. Duty to Comply

1. The discharger shall comply with all of the conditions of this General Permit. Any permit noncompliance constitutes a violation of the Clean Water Act (CWA) and the Porter-Cologne Water Quality Control Act and is grounds for enforcement action and/or removal from General Permit coverage.
2. The discharger shall comply with effluent standards or prohibitions established under Section 307(a) of the CWA for toxic pollutants within the time provided in the regulations that establish these standards or prohibitions, even if this General Permit has not yet been modified to incorporate the requirement.

B. General Permit Actions

1. This General Permit may be modified, revoked and reissued, or terminated for cause. The filing of a request by the discharger for a General Permit modification, revocation and reissuance, or termination, or a notification of planned changes or anticipated noncompliance does not annul any General Permit condition.
2. If any toxic effluent standard or prohibition (including any schedule of compliance specified in such effluent standard or prohibition) is promulgated under Section 307(a) of the CWA for a toxic pollutant which is present in the discharge and that standard or prohibition is more stringent than any limitation on the pollutant in this General Permit, this General Permit shall be modified or revoked and reissued to conform to the toxic effluent standard or prohibition and the dischargers so notified.

C. Need to Halt or Reduce Activity Not a Defense

It shall not be a defense for a discharger in an enforcement action that it would have been necessary to halt or reduce the permitted activity in order to maintain compliance with the conditions of this General Permit.

D. Duty to Mitigate

The discharger shall take all responsible steps to minimize or prevent any discharge in violation of this General Permit, which has a reasonable likelihood of adversely affecting human health or the environment.

E. Proper Operation and Maintenance

The discharger shall at all times properly operate and maintain any facilities and systems of treatment and control (and related appurtenances) which are installed or used by the discharger to achieve compliance with the conditions of this General Permit. Proper operation and maintenance also includes adequate laboratory controls and appropriate quality assurance procedures. Proper operation and maintenance may require the operation of backup or auxiliary facilities or similar systems installed by a discharger when necessary to achieve compliance with the conditions of this General Permit.

F. Property Rights

This General Permit does not convey any property rights of any sort or any exclusive privileges, nor does it authorize any injury to private property or any invasion of personal rights, nor does it authorize any infringement of Federal, State, or local laws or regulations.

G. Duty to Maintain Records and Provide Information

1. The discharger shall maintain a paper or electronic copy of all required records, including a copy of this General Permit, for three years from the date generated or date submitted, whichever is last. These records shall be available at the construction site until construction is completed.
2. The discharger shall furnish the Regional Water Board, State Water Board, or U.S. EPA, within a reasonable time, any requested information to determine compliance with this General Permit. The discharger shall also furnish, upon request, copies of records that are required to be kept by this General Permit.

H. Inspection and Entry

The discharger shall allow the Regional Water Board, State Water Board, U.S. EPA, and/or, in the case of construction sites which discharge through a municipal separate storm sewer, an authorized representative of the municipal operator of the separate storm sewer system receiving the discharge, upon the presentation of credentials and other documents as may be required by law, to:

1. Enter upon the discharger's premises at reasonable times where a regulated construction activity is being conducted or where records must be kept under the conditions of this General Permit;

2. Access and copy at reasonable times any records that must be kept under the conditions of this General Permit;
3. Inspect at reasonable times the complete construction site, including any off-site staging areas or material storage areas, and the erosion/sediment controls; and
4. Sample or monitor at reasonable times for the purpose of ensuring General Permit compliance.

I. Electronic Signature and Certification Requirements

1. All Permit Registration Documents (PRDs) and Notices of Termination (NOTs) shall be electronically signed, certified, and submitted via SMARTS to the State Water Board. Either the Legally Responsible Person (LRP), as defined in Appendix 5 – Glossary, or a person legally authorized to sign and certify PRDs and NOTs on behalf of the LRP (the LRP's Approved Signatory, as defined in Appendix 5 - Glossary) must submit all information electronically via SMARTS.
2. Changes to Authorization. If an Approved Signatory's authorization is no longer accurate, a new authorization satisfying the requirements of paragraph (a) of this section must be submitted via SMARTS prior to or together with any reports, information or applications to be signed by an Approved Signatory.
3. All Annual Reports, or other information required by the General Permit (other than PRDs and NOTs) or requested by the Regional Water Board, State Water Board, U.S. EPA, or local storm water management agency shall be certified and submitted by the LRP or the LRP's Approved Signatory.

J. Certification

Any person signing documents under Section IV.I above, shall make the following certification:

"I certify under penalty of law that this document and all attachments were prepared under my direction or supervision in accordance with a system designed to assure that qualified personnel properly gather and evaluate the information submitted. Based on my inquiry of the person or persons who manage the system or those persons directly responsible for gathering the information, to the best of my knowledge and belief, the information submitted is, true, accurate, and complete. I am aware that there are significant penalties for submitting false information, including the possibility of fine and imprisonment for knowing violations."

K. Anticipated Noncompliance

The discharger shall give advance notice to the Regional Water Board and local storm water management agency of any planned changes in the construction activity, which may result in noncompliance with General Permit requirements.

L. Bypass

Bypass⁸ is prohibited. The Regional Water Board may take enforcement action against the discharger for bypass unless:

1. Bypass was unavoidable to prevent loss of life, personal injury or severe property damage;⁹
2. There were no feasible alternatives to bypass, such as the use of auxiliary treatment facilities, retention of untreated waste, or maintenance during normal periods of equipment downtime. This condition is not satisfied if adequate back-up equipment should have been installed in the exercise of reasonable engineering judgment to prevent a bypass that could occur during normal periods of equipment downtime or preventative maintenance;
3. The discharger submitted a notice at least ten days in advance of the need for a bypass to the Regional Water Board; or
4. The discharger may allow a bypass to occur that does not cause effluent limitations to be exceeded, but only if it is for essential maintenance to assure efficient operation. In such a case, the above bypass conditions are not applicable. The discharger shall submit notice of an unanticipated bypass as required.

M. Upset

1. A discharger that wishes to establish the affirmative defense of an upset¹⁰ in an action brought for noncompliance shall demonstrate,

⁸ The intentional diversion of waste streams from any portion of a treatment facility

⁹ Severe property damage means substantial physical damage to property, damage to the treatment facilities that causes them to become inoperable, or substantial and permanent loss of natural resources that can reasonably be expected to occur in the absence of a bypass. Severe property damage does not mean economic loss caused by delays in production.

¹⁰ An exceptional incident in which there is unintentional and temporary noncompliance the technology based numeric effluent limitations because of factors beyond the reasonable control of the discharger. An upset does not include noncompliance to the extent caused by operational error, improperly designed treatment facilities, inadequate treatment facilities, lack of preventative maintenance, or careless or improper operation.

through properly signed, contemporaneous operating logs, or other relevant evidence that:

- a. An upset occurred and that the discharger can identify the cause(s) of the upset
 - b. The treatment facility was being properly operated by the time of the upset
 - c. The discharger submitted notice of the upset as required; and
 - d. The discharger complied with any remedial measures required
2. No determination made before an action of noncompliance occurs, such as during administrative review of claims that noncompliance was caused by an upset, is final administrative action subject to judicial review.
 3. In any enforcement proceeding, the discharger seeking to establish the occurrence of an upset has the burden of proof

N. Penalties for Falsification of Reports

Section 309(c)(4) of the CWA provides that any person who knowingly makes any false material statement, representation, or certification in any record or other document submitted or required to be maintained under this General Permit, including reports of compliance or noncompliance shall upon conviction, be punished by a fine of not more than \$10,000 or by imprisonment for not more than two years or by both.

O. Oil and Hazardous Substance Liability

Nothing in this General Permit shall be construed to preclude the institution of any legal action or relieve the discharger from any responsibilities, liabilities, or penalties to which the discharger is or may be subject to under Section 311 of the CWA.

P. Severability

The provisions of this General Permit are severable; and, if any provision of this General Permit or the application of any provision of this General Permit to any circumstance is held invalid, the application of such provision to other circumstances and the remainder of this General Permit shall not be affected thereby.

Q. Reopener Clause

This General Permit may be modified, revoked and reissued, or terminated for cause due to promulgation of amended regulations, receipt of U.S. EPA guidance concerning regulated activities, judicial decision, or in accordance with 40 Code of Federal Regulations (CFR) 122.62, 122.63, 122.64, and 124.5.

R. Penalties for Violations of Permit Conditions

1. Section 309 of the CWA provides significant penalties for any person who violates a permit condition implementing Sections 301, 302, 306, 307, 308, 318, or 405 of the CWA or any permit condition or limitation implementing any such section in a permit issued under Section 402. Any person who violates any permit condition of this General Permit is subject to a civil penalty not to exceed \$37,500¹¹ per calendar day of such violation, as well as any other appropriate sanction provided by Section 309 of the CWA.
2. The Porter-Cologne Water Quality Control Act also provides for civil and criminal penalties, which in some cases are greater than those under the CWA.

S. Transfers

This General Permit is not transferable.

T. Continuation of Expired Permit

This General Permit continues in force and effect until a new General Permit is issued or the SWRCB rescinds this General Permit. Only those dischargers authorized to discharge under the expiring General Permit are covered by the continued General Permit.

¹¹ May be further adjusted in accordance with the Federal Civil Penalties Inflation Adjustment Act.

V. EFFLUENT STANDARDS & RECEIVING WATER MONITORING

A. Narrative Effluent Limitations

1. Storm water discharges and authorized non-storm water discharges regulated by this General Permit shall not contain a hazardous substance equal to or in excess of reportable quantities established in 40 C.F.R. §§ 117.3 and 302.4, unless a separate NPDES Permit has been issued to regulate those discharges.
2. Dischargers shall minimize or prevent pollutants in storm water discharges and authorized non-storm water discharges through the use of controls, structures, and management practices that achieve BAT for toxic and non-conventional pollutants and BCT for conventional pollutants.

Table 1- Numeric Action Levels, Test Methods, Detection Limits, and Reporting Units

Parameter	Test Method	Discharge Type	Min. Detection Limit	Units	Numeric Action Level
pH	Field test with calibrated portable instrument	Risk Level 2	0.2	pH units	lower NAL = 6.5 upper NAL = 8.5
		Risk Level 3			lower NAL = 6.5 upper NAL = 8.5
Turbidity	EPA 0180.1 and/or field test with calibrated portable instrument	Risk Level 2	1	NTU	250 NTU
		Risk Level 3			250 NTU

B. Numeric Action Levels (NALs)

1. For Risk Level 2 and 3 dischargers, the lower storm event average NAL for pH is 6.5 pH units and the upper storm event average NAL for

pH is 8.5 pH units. The discharger shall take actions as described below if the discharge is outside of this range of pH values.

2. For Risk Level 2 and 3 dischargers, the NAL storm event daily average for turbidity is 250 NTU. The discharger shall take actions as described below if the discharge is outside of this range of turbidity values.
3. Whenever the results from a storm event daily average indicate that the discharge is below the lower NAL for pH, exceeds the upper NAL for pH, or exceeds the turbidity NAL (as listed in Table 1), the discharger shall conduct a construction site and run-on evaluation to determine whether pollutant source(s) associated with the site's construction activity may have caused or contributed to the NAL exceedance and shall immediately implement corrective actions if they are needed.
4. The site evaluation shall be documented in the SWPPP and specifically address whether the source(s) of the pollutants causing the exceedance of the NAL:
 - a. Are related to the construction activities and whether additional BMPs are required to (1) meet BAT/BCT requirements; (2) reduce or prevent pollutants in storm water discharges from causing exceedances of receiving water objectives; and (3) determine what corrective action(s) were taken or will be taken and with a description of the schedule for completion.

AND/OR:

- b. Are related to the run-on associated with the construction site location and whether additional BMPs measures are required to (1) meet BAT/BCT requirements; (2) reduce or prevent pollutants in storm water discharges from causing exceedances of receiving water objectives; and (3) what corrective action(s) were taken or will be taken with a description of the schedule for completion.

C. Receiving Water Monitoring Triggers

1. The receiving water monitoring triggers for Risk Level 3 dischargers with direct discharges to surface waters are triggered when the daily average effluent pH values during any site phase when there is a high risk of pH discharge¹² fall outside of the range of 6.0 and 9.0 pH units, or when the daily average effluent turbidity exceeds 500 NTU.

2. Risk Level 3 dischargers with with direct discharges to surface waters shall conduct receiving water monitoring whenever their effluent monitoring results exceed the receiving water monitoring triggers. If the pH trigger is exceeded, the receiving water shall be monitored for pH for the duration of coverage under this General Permit. If the turbidity trigger is exceeded, the receiving water shall be monitored for turbidity and SSC for the duration of coverage under this general permit.
3. Risk Level 3 dischargers with direct discharges to surfaces waters shall initiate receiving water monitoring when the triggers are exceeded unless the storm event causing the exceedance is determined after the fact to equal to or greater than the 5-year 24-hour storm (expressed in inches of rainfall) as determined by using these maps:

<http://www.wrcc.dri.edu/pcpnfreq/nca5y24.gif>
<http://www.wrcc.dri.edu/pcpnfreq/sca5y24.gif>

Verification of the 5-year 24-hour storm event shall be done by reporting on-site rain gauge readings as well as nearby governmental rain gauge readings.

4. If run-on is caused by a forest fire or any other natural disaster, then receiving water monitoring triggers do not apply.

¹² A period of high risk of pH discharge is defined as a project's complete utilities phase, complete vertical build phase, and any portion of any phase where significant amounts of materials are placed directly on the land at the site in a manner that could result in significant alterations of the background pH of the discharges.

VI. RECEIVING WATER LIMITATIONS

- A.** The discharger shall ensure that storm water discharges and authorized non-storm water discharges to any surface or ground water will not adversely affect human health or the environment.
- B.** The discharger shall ensure that storm water discharges and authorized non-storm water discharges will not contain pollutants in quantities that threaten to cause pollution or a public nuisance.
- C.** The discharger shall ensure that storm water discharges and authorized non-storm water discharges will not contain pollutants that cause or contribute to an exceedance of any applicable water quality objectives or water quality standards (collectively, WQS) contained in a Statewide Water Quality Control Plan, the California Toxics Rule, the National Toxics Rule, or the applicable Regional Water Board's Water Quality Control Plan (Basin Plan).
- D.** Dischargers located within the watershed of a CWA § 303(d) impaired water body, for which a TMDL has been approved by the U.S. EPA, shall comply with the approved TMDL if it identifies "construction activity" or land disturbance as a source of the pollution.

VII. TRAINING QUALIFICATIONS AND CERTIFICATION REQUIREMENTS

A. General

The discharger shall ensure that all persons responsible for implementing requirements of this General Permit shall be appropriately trained in accordance with this Section. Training should be both formal and informal, occur on an ongoing basis, and should include training offered by recognized governmental agencies or professional organizations. Those responsible for preparing and amending SWPPPs shall comply with the requirements in this Section VII.

The discharger shall provide documentation of all training for persons responsible for implementing the requirements of this General Permit in the Annual Reports.

B. SWPPP Certification Requirements

1. **Qualified SWPPP Developer:** The discharger shall ensure that SWPPPs are written, amended and certified by a Qualified SWPPP Developer (QSD). A QSD shall have one of the following registrations or certifications, and appropriate experience, as required for:
 - a. A California registered professional civil engineer;
 - b. A California registered professional geologist or engineering geologist;
 - c. A California registered landscape architect;
 - d. A professional hydrologist registered through the American Institute of Hydrology;
 - e. A Certified Professional in Erosion and Sediment Control (CPESC)TM registered through Enviro Cert International, Inc.;
 - f. A Certified Professional in Storm Water Quality (CPSWQ)TM registered through Enviro Cert International, Inc.; or
 - g. A professional in erosion and sediment control registered through the National Institute for Certification in Engineering Technologies (NICET).

Effective two years after the adoption date of this General Permit, a QSD shall have attended a State Water Board-sponsored or approved QSD training course.

2. The discharger shall list the name and telephone number of the currently designated Qualified SWPPP Developer(s) in the SWPPP.
3. **Qualified SWPPP Practitioner:** The discharger shall ensure that all BMPs required by this General Permit are implemented by a Qualified SWPPP Practitioner (QSP). A QSP is a person responsible for non-storm water and storm water visual observations, sampling and analysis. Effective two years from the date of adoption of this General Permit, a QSP shall be either a QSD or have one of the following certifications:
 - a. A certified erosion, sediment and storm water inspector registered through Enviro Cert International, Inc.; or
 - b. A certified inspector of sediment and erosion control registered through Certified Inspector of Sediment and Erosion Control, Inc.

Effective two years after the adoption date of this General Permit, a QSP shall have attended a State Water Board-sponsored or approved QSP training course.

4. The LRP shall list in the SWPPP, the name of any Approved Signatory, and provide a copy of the written agreement or other mechanism that provides this authority from the LRP in the SWPPP.
5. The discharger shall include, in the SWPPP, a list of names of all contractors, subcontractors, and individuals who will be directed by the Qualified SWPPP Practitioner. This list shall include telephone numbers and work addresses. Specific areas of responsibility of each subcontractor and emergency contact numbers shall also be included.
6. The discharger shall ensure that the SWPPP and each amendment will be signed by the Qualified SWPPP Developer. The discharger shall include a listing of the date of initial preparation and the date of each amendment in the SWPPP.

VIII. RISK DETERMINATION

The discharger shall calculate the site's sediment risk and receiving water risk during periods of soil exposure (i.e. grading and site stabilization) and use the calculated risks to determine a Risk Level(s) using the methodology in

Appendix 1. For any site that spans two or more planning watersheds,¹³ the discharger shall calculate a separate Risk Level for each planning watershed. The discharger shall notify the State Water Board of the site's Risk Level determination(s) and shall include this determination as a part of submitting the PRDs. If a discharger ends up with more than one Risk Level determination, the Regional Water Board may choose to break the project into separate levels of implementation.

IX. RISK LEVEL 1 REQUIREMENTS

Risk Level 1 Dischargers shall comply with the requirements included in Attachment C of this General Permit.

X. RISK LEVEL 2 REQUIREMENTS

Risk Level 2 Dischargers shall comply with the requirements included in Attachment D of this General Permit.

XI. RISK LEVEL 3 REQUIREMENTS

Risk Level 3 Dischargers shall comply with the requirements included in Attachment E of this General Permit.

XII. ACTIVE TREATMENT SYSTEMS (ATS)

Dischargers choosing to implement an ATS on their site shall comply with all of the requirements in Attachment F of this General Permit.

¹³ Planning watershed: defined by the Calwater Watershed documents as a watershed that ranges in size from approximately 3,000 to 10,000 acres <http://cain.ice.ucdavis.edu/calwater/calwfaq.html>, <http://gis.ca.gov/catalog/BrowseRecord.epl?id=22175> .

XIII. POST-CONSTRUCTION STANDARDS

- A.** All dischargers shall comply with the following runoff reduction requirements unless they are located within an area subject to post-construction standards of an active Phase I or II municipal separate storm sewer system (MS4) permit that has an approved Storm Water Management Plan.
1. This provision shall take effect three years from the adoption date of this permit, or later at the discretion of the Executive Officer of the Regional Board.
 2. The discharger shall demonstrate compliance with the requirements of this section by submitting with their NOI a map and worksheets in accordance with the instructions in Appendix 2. The discharger shall use non-structural controls unless the discharger demonstrates that non-structural controls are infeasible or that structural controls will produce greater reduction in water quality impacts.
 3. The discharger shall, through the use of non-structural and structural measures as described in Appendix 2, replicate the pre-project water balance (for this permit, defined as the volume of rainfall that ends up as runoff) for the smallest storms up to the 85th percentile storm event (or the smallest storm event that generates runoff, whichever is larger). Dischargers shall inform Regional Water Board staff at least 30 days prior to the use of any structural control measure used to comply with this requirement. Volume that cannot be addressed using non-structural practices shall be captured in structural practices and approved by the Regional Water Board. When seeking Regional Board approval for the use of structural practices, dischargers shall document the infeasibility of using non-structural practices on the project site, or document that there will be fewer water quality impacts through the use of structural practices.
 4. For sites whose disturbed area exceeds two acres, the discharger shall preserve the pre-construction drainage density (miles of stream length per square mile of drainage area) for all drainage areas within the area serving a first order stream¹⁴ or larger stream and ensure that post-project time of runoff concentration is equal or greater than pre-project time of concentration.

¹⁴ A first order stream is defined as a stream with no tributaries.

- B.** All dischargers shall implement BMPs to reduce pollutants in storm water discharges that are reasonably foreseeable after all construction phases have been completed at the site (Post-construction BMPs).

XIV. SWPPP REQUIREMENTS

- A.** The discharger shall ensure that the Storm Water Pollution Prevention Plans (SWPPPs) for all traditional project sites are developed and amended or revised by a QSD. The SWPPP shall be designed to address the following objectives:
1. All pollutants and their sources, including sources of sediment associated with construction, construction site erosion and all other activities associated with construction activity are controlled;
 2. Where not otherwise required to be under a Regional Water Board permit, all non-storm water discharges are identified and either eliminated, controlled, or treated;
 3. Site BMPs are effective and result in the reduction or elimination of pollutants in storm water discharges and authorized non-storm water discharges from construction activity to the BAT/BCT standard;
 4. Calculations and design details as well as BMP controls for site run-on are complete and correct, and
 5. Stabilization BMPs installed to reduce or eliminate pollutants after construction are completed.
- B.** To demonstrate compliance with requirements of this General Permit, the QSD shall include information in the SWPPP that supports the conclusions, selections, use, and maintenance of BMPs.
- C.** The discharger shall make the SWPPP available at the construction site during working hours while construction is occurring and shall be made available upon request by a State or Municipal inspector. When the original SWPPP is retained by a crewmember in a construction vehicle and is not currently at the construction site, current copies of the BMPs and map/drawing will be left with the field crew and the original SWPPP shall be made available via a request by radio/telephone.

XV. REGIONAL WATER BOARD AUTHORITIES

- A.** In the case where the Regional Water Board does not agree with the discharger's self-reported risk level (e.g., they determine themselves to be a Level 1 Risk when they are actually a Level 2 Risk site), Regional Water Boards may either direct the discharger to reevaluate the Risk Level(s) for their site or terminate coverage under this General Permit.
- B.** Regional Water Boards may terminate coverage under this General Permit for dischargers who fail to comply with its requirements or where they determine that an individual NPDES permit is appropriate.
- C.** Regional Water Boards may require dischargers to submit a Report of Waste Discharge / NPDES permit application for Regional Water Board consideration of individual requirements.
- D.** Regional Water Boards may require additional Monitoring and Reporting Program Requirements, including sampling and analysis of discharges to sediment-impaired water bodies.
- E.** Regional Water Boards may require dischargers to retain records for more than the three years required by this General Permit.

XVI. ANNUAL REPORTING REQUIREMENTS

- A.** All dischargers shall prepare and electronically submit an Annual Report no later than September 1 of each year.
- B.** The discharger shall certify each Annual Report in accordance with the Special Provisions.
- C.** The discharger shall retain an electronic or paper copy of each Annual Report for a minimum of three years after the date the annual report is filed.
- D.** The discharger shall include storm water monitoring information in the Annual Report consisting of:
 - 1. a summary and evaluation of all sampling and analysis results, including copies of laboratory reports;
 - 2. the analytical method(s), method reporting unit(s), and method detection limit(s) of each analytical parameter (analytical results that are less than the method detection limit shall be reported as "less than the method detection limit");
 - 3. a summary of all corrective actions taken during the compliance year;
 - 4. identification of any compliance activities or corrective actions that were not implemented;
 - 5. a summary of all violations of the General Permit;
 - 6. the names of individual(s) who performed the facility inspections, sampling, visual observation (inspections), and/or measurements;
 - 7. the date, place, time of facility inspections, sampling, visual observation (inspections), and/or measurements, including precipitation (rain gauge); and
 - 8. the visual observation and sample collection exception records and reports specified in Attachments C, D, and E.
- E.** The discharger shall provide training information in the Annual Report consisting of:
 - 1. documentation of all training for individuals responsible for all activities associated with compliance with this General Permit;

2. documentation of all training for individuals responsible for BMP installation, inspection, maintenance, and repair; and
3. documentation of all training for individuals responsible for overseeing, revising, and amending the SWPPP.

**ATTACHMENT A
Linear Underground/ Overhead Requirements**

A. DEFINITION OF LINEAR UNDERGROUND/OVERHEAD PROJECTS 1
 B. LINEAR PROJECT PERMIT REGISTRATION DOCUMENTS (PRDs) 3
 C. LINEAR PROJECT TERMINATION OF COVERAGE REQUIREMENTS.. 4
 D. DISCHARGE PROHIBITIONS 6
 E. SPECIAL PROVISIONS..... 8
 F. EFFLUENT STANDARDS & RECEIVING WATER MONITORING 13
 G. RECEIVING WATER LIMITATIONS 16
 H. TRAINING QUALIFICATIONS 17
 I. TYPES OF LINEAR PROJECTS 19
 J. LUP TYPE-SPECIFIC REQUIREMENTS 20
 K. STORM WATER POLLUTION PREVENTION PLAN (SWPPP)
 REQUIREMENTS 28
 L. REGIONAL WATER BOARD AUTHORITIES 29
 M. MONITORING AND REPORTING REQUIREMENTS 31

All Linear Underground/Overhead project dischargers who submit permit registration documents (PRDs) indicating their intention to be regulated under the provisions of this General Permit shall comply with the following:

A. DEFINITION OF LINEAR UNDERGROUND/OVERHEAD PROJECTS

1. Linear Underground/Overhead Projects (LUPs) include, but are not limited to, any conveyance, pipe, or pipeline for the transportation of any gaseous, liquid (including water and wastewater for domestic municipal services), liquescent, or slurry substance; any cable line or wire for the transmission of electrical energy; any cable line or wire for communications (e.g., telephone, telegraph, radio, or television messages); and associated ancillary facilities. Construction activities associated with LUPs include, but are not limited to, (a) those activities necessary for the installation of underground and overhead linear facilities (e.g., conduits, substructures, pipelines, towers, poles, cables, wires, connectors, switching, regulating and transforming equipment, and associated ancillary facilities); and include, but are not limited to, (b) underground utility mark-out, potholing, concrete and asphalt cutting and removal, trenching, excavation, boring and drilling, access road and pole/tower pad and cable/wire pull station, substation construction, substructure installation, construction of tower footings and/or foundations, pole and tower installations, pipeline installations, welding, concrete and/ or pavement repair or replacement, and stockpile/borrow locations.
2. LUP evaluation shall consist of two tasks:

- a. Confirm that the project or project section(s) qualifies as an LUP. The State Water Board website contains a project determination guidance flowchart.
http://www.waterboards.ca.gov/water_issues/programs/stormwater/constructionpermits.shtml
 - b. Identify which Type(s) (1, 2 or 3 described in Section I below) are applicable to the project or project sections based on project sediment and receiving water risk. (See Attachment A.1)
3. A Legally Responsible Person (LRP) for a Linear Underground/Overhead project is required to obtain CGP coverage under one or more permit registration document (PRD) electronic submittals to the State Water Board's Storm Water Multi-Application and Report Tracking (SMARTs) system. Attachment A.1 contains a flow chart to be used when determining if a linear project qualifies for coverage and to determine LUP Types. Since a LUP may be constructed within both developed and undeveloped locations and portions of LUPs may be constructed by different contractors, LUPs may be broken into logical permit sections. Sections may be determined based on portions of a project conducted by one contractor. Other situations may also occur, such as the time period in which the sections of a project will be constructed (e.g. project phases), for which separate permit coverage is possible. For projects that are broken into separate sections, a description of how each section relates to the overall project and the definition of the boundaries between sections shall be clearly stated.
 4. Where construction activities transverse or enter into different Regional Water Board jurisdictions, LRPs shall obtain permit coverage for each Regional Water Board area involved prior to the commencement of construction activities.
 5. Small Construction Rainfall Erosivity Waiver

EPA's Small Construction Erosivity Waiver applies to sites between one and five acres demonstrating that there are no adverse water quality impacts.

Dischargers eligible for a Rainfall Erosivity Waiver based on low erosivity potential shall complete the electronic Notice of Intent (NOI) and Sediment Risk form through the State Water Board's SMARTS system, certifying that the construction activity will take place during a period when the value of the rainfall erosivity factor is less than five. Where the LRP changes or another LRP is added during construction, the new LRP must also submit a waiver certification through the SMARTS system.

If a small linear construction site continues beyond the projected completion date given on the waiver certification, the LRP shall recalculate the rainfall erosivity factor for the new project duration and submit this information through the SMARTS system. If the new R factor is below five (5), the discharger shall update through SMARTS all applicable information on the waiver certification and retain a copy of the revised waiver onsite. The LRP shall submit the new waiver certification 30 days prior to the projected completion date listed on the original waiver form to assure exemption from permitting requirements is uninterrupted. If the new R factor is five (5) or above, the LRP shall be required to apply for coverage under this Order.

B. LINEAR PROJECT PERMIT REGISTRATION DOCUMENTS (PRDs)

Any information provided to the Regional Water Board shall comply with the Homeland Security Act and any other federal law that concerns security in the United States; any information that does not comply should not be submitted. PRDs shall consist of the following:

1. Notice of Intent (NOI)

Prior to construction activities, the LRP of a proposed linear underground/overhead project shall utilize the processes and methods provided in Attachment A.2, Permit Registration Documents (PRDs) – General Instructions for Linear Underground/Overhead Projects to comply with the Construction General Permit.

2. Site Maps

LRPs submitting PRDs shall include at least 3 maps. The first map will be a zoomed¹ 1000-1500 ft vicinity map that shows the starting point of the project. The second will be a zoomed map of 1000-1500 ft showing the ending location of the project. The third will be a larger view vicinity map, 1000 ft to 2000 ft, displaying the entire project location depending on the project size, and indicating the LUP type (1, 2 or 3) areas within the total project footprint.

3. Drawings

LRPs submitting PRDs shall include a construction drawing(s) or other appropriate drawing(s) or map(s) that shows the locations of storm drain

¹ An image with a close-up/enhanced detailed view of site features that show minute details such as streets and neighboring structures.

Or: An image with a close-up/enhanced detailed view of the site's surrounding infrastructure.

Or: An image with a close up detailed view of the project and its surroundings.

inlets and waterbodies² that may receive discharges from the construction activities and that shows the locations of BMPs to be installed for all those BMPs that can be illustrated on the revisable drawing(s) or map(s). If storm drain inlets, waterbodies, and/or BMPs cannot be adequately shown on the drawing(s) or map(s) they should be described in detail within the SWPPP.

4. Storm Water Pollution Prevention Plan (SWPPP)

LUP dischargers shall comply with the SWPPP Preparation, Implementation, and Oversight requirements in Section K of this Attachment.

5. Contact information

LUP dischargers shall include contact information for all contractors (or subcontractors) responsible for each area of an LUP project. This should include the names, telephone numbers, and addresses of contact personnel. Specific areas of responsibility of each contact, and emergency contact numbers should also be included.

6. In the case of a public emergency that requires immediate construction activities, a discharger shall submit a brief description of the emergency construction activity within five days of the onset of construction, and then shall submit all PRDs within thirty days.

C. LINEAR PROJECT TERMINATION OF COVERAGE REQUIREMENTS

The LRP may terminate coverage of an LUP when construction activities are completed by submitting an electronic notice of termination (NOT) through the State Water Board's SMARTS system. Termination requirements are different depending on the complexity of the LUP. An LUP is considered complete when: (a) there is no potential for construction-related storm water pollution; (b) all elements of the SWPPP have been completed; (c) construction materials and waste have been disposed of properly; (d) the site is in compliance with all local storm water management requirements; and (e) the LRP submits a notice of termination (NOT) and has received approval for termination from the appropriate Regional Water Board office.

1. LUP Stabilization Requirements

The LUP discharger shall ensure that all disturbed areas of the construction site are stabilized prior to termination of coverage under this General Permit. Final stabilization for the purposes of submitting an NOT

² Includes basin(s) that the MS4 storm sewer systems may drain to for Hydromodification or Hydrological Conditional of Concerns under the MS4 permits.

is satisfied when all soil disturbing activities are completed and one of the following criteria is met:

- a. In disturbed areas that were vegetated prior to construction activities of the LUP, the area disturbed must be re-established to a uniform vegetative cover equivalent to 70 percent coverage of the preconstruction vegetative conditions. Where preconstruction vegetation covers less than 100 percent of the surface, such as in arid areas, the 70 percent coverage criteria is adjusted as follows: if the preconstruction vegetation covers 50 percent of the ground surface, 70 percent of 50 percent ($.70 \times .50 = .35$) would require 35 percent total uniform surface coverage; or
- b. Where no vegetation is present prior to construction, the site is returned to its original line and grade and/or compacted to achieve stabilization; or
- c. Equivalent stabilization measures have been employed. These measures include, but are not limited to, the use of such BMPs as blankets, reinforced channel liners, soil cement, fiber matrices, geotextiles, or other erosion resistant soil coverings or treatments.

2. LUP Termination of Coverage Requirements

The LRP shall file an NOT through the State Water Board's SMARTS system. By submitting an NOT, the LRP is certifying that construction activities for an LUP are complete and that the project is in full compliance with requirements of this General Permit and that it is now compliant with soil stabilization requirements where appropriate. Upon approval by the appropriate Regional Water Board office, permit coverage will be terminated.

3. Revising Coverage for Change of Acreage

When the LRP of a portion of an LUP construction project changes, or when a phase within a multi-phase project is completed, the LRP may reduce the total acreage covered by this General Permit. In reducing the acreage covered by this General Permit, the LRP shall electronically file revisions to the PRDs that include:

- a. a revised NOI indicating the new project size;
- b. a revised site map showing the acreage of the project completed, acreage currently under construction, acreage sold, transferred or added, and acreage currently stabilized.
- c. SWPPP revisions, as appropriate; and
- d. certification that any new LRPs have been notified of applicable requirements to obtain General Permit coverage. The certification shall include the name, address, telephone number, and e-mail address (if known) of the new LRP.

If the project acreage has increased, dischargers shall mail payment of revised annual fees within 14 days of receiving the revised annual fee notification.

D. DISCHARGE PROHIBITIONS

1. LUP dischargers shall not violate any discharge prohibitions contained in applicable Basin Plans or statewide water quality control plans. Waste discharges to Areas of Special Biological Significance (ASBS) are prohibited by the California Ocean Plan, unless granted an exception issued by the State Water Board.
2. LUP dischargers are prohibited from discharging non-storm water that is not otherwise authorized by this General Permit. Non-storm water discharges authorized by this General Permit³ may include, fire hydrant flushing, irrigation of vegetative erosion control measures, pipe flushing and testing, water to control dust, street cleaning, dewatering,⁴ uncontaminated groundwater from dewatering, and other discharges not subject to a separate general NPDES permit adopted by a Regional Water Board. Such discharges are allowed by this General Permit provided they are not relied upon to clean up failed or inadequate construction or post-construction BMPs designed to keep materials on site. These authorized non-storm water discharges:

³ Dischargers must identify all authorized non-storm water discharges in the LUP's SWPPP and identify BMPs that will be implemented to either eliminate or reduce pollutants in non-storm water discharges. Regional Water Boards may direct the discharger to discontinue discharging such non-storm water discharges if determined that such discharges discharge significant pollutants or threaten water quality.

⁴Dewatering activities may be prohibited or need coverage under a separate permit issued by the Regional Water Boards. Dischargers shall check with the appropriate Regional Water Boards for any required permit or basin plan conditions prior to initial dewatering activities to land, storm drains, or waterbodies.

- a. Shall not cause or contribute to a violation of any water quality standard;
- b. Shall not violate any other provision of this General Permit;
- c. Shall not violate any applicable Basin Plan;
- d. Shall comply with BMPs as described in the SWPPP;
- e. Shall not contain toxic constituents in toxic amounts or (other) significant quantities of pollutants;
- f. Shall be monitored and meets the applicable NALs; and
- g. Shall be reported by the discharger in the Annual Report.

If any of the above conditions are not satisfied, the discharge is not authorized by this General Permit. The discharger shall notify the Regional Water Board of any anticipated non-storm water discharges not authorized by this General Permit to determine the need for a separate NPDES permit.

Additionally, some LUP dischargers may be required to obtain a separate permit if the applicable Regional Water Board has adopted a General Permit for dewatering discharges. Wherever feasible, alternatives, that do not result in the discharge of non-storm water, shall be implemented in accordance with this Attachment's Section K.2 - SWPPP Implementation Schedule.

3. LUP dischargers shall ensure that trench spoils or any other soils disturbed during construction activities that are contaminated⁵ are not discharged with storm water or non-storm water discharges into any storm drain or water body except pursuant to an NPDES permit.

When soil contamination is found or suspected and a responsible party is not identified, or the responsible party fails to promptly take the appropriate action, the LUP discharger shall have those soils sampled and tested to ensure that proper handling and public safety measures are

⁵ Contaminated soil contains pollutants in concentrations that exceed the appropriate thresholds that various regulatory agencies set for those substances. Preliminary testing of potentially contaminated soils will be based on odor, soil discoloration, or prior history of the site's chemical use and storage and other similar factors. When soil contamination is found or suspected and a responsible party is not identified, or the responsible party fails to promptly take the appropriate action, the discharger shall have those soils sampled and tested to ensure proper handling and public safety measures are implemented. The legally responsible person will notify the appropriate local, State, or federal agency(ies) when contaminated soil is found at a construction site, and will notify the Regional Water Board by submitting an NOT at the completion of the project.

- implemented. The LUP discharger shall notify the appropriate local, State, and federal agency(ies) when contaminated soil is found at a construction site, and will notify the appropriate Regional Water Board.
4. Discharging any pollutant-laden water that will cause or contribute to an exceedance of the applicable Regional Water Board's Basin Plan from a dewatering site or sediment basin into any receiving water or storm drain is prohibited.
 5. Debris⁶ resulting from construction activities are prohibited from being discharged from construction project sites.

E. SPECIAL PROVISIONS

1. Duty to Comply

- a. The LUP discharger must comply with all of the conditions of this General Permit. Any permit noncompliance constitutes a violation of the Clean Water Act (CWA) and the Porter-Cologne Water Quality Control Act and is grounds for enforcement action and/or removal from General Permit coverage.
- b. The LUP discharger shall comply with effluent standards or prohibitions established under Section 307(a) of the CWA for toxic pollutants within the time provided in the regulations that establish these standards or prohibitions, even if this General Permit has not yet been modified to incorporate the requirement.

2. General Permit Actions

- a. This General Permit may be modified, revoked and reissued, or terminated for cause. The filing of a request by the discharger for a General Permit modification, revocation and reissuance, or termination, or a notification of planned changes or anticipated noncompliance does not annul any General Permit condition.

⁶ Litter, rubble, discarded refuse, and remains of something destroyed.

- b. If any toxic effluent standard or prohibition (including any schedule of compliance specified in such effluent standard or prohibition) is promulgated under Section 307(a) of the CWA for a toxic pollutant which is present in the discharge and that standard or prohibition is more stringent than any limitation on the pollutant in this General Permit, this General Permit shall be modified or revoked and reissued to conform to the toxic effluent standard or prohibition and the dischargers so notified.

3. Need to Halt or Reduce Activity Not a Defense

It shall not be a defense for an LUP discharger in an enforcement action that it would have been necessary to halt or reduce the permitted activity in order to maintain compliance with the conditions of this General Permit.

4. Duty to Mitigate

The LUP discharger shall take all responsible steps to minimize or prevent any discharge in violation of this General Permit, which has a reasonable likelihood of adversely affecting human health or the environment.

5. Proper Operation and Maintenance

The LUP discharger shall at all times properly operate and maintain any facilities and systems of treatment and control (and related appurtenances) which are installed or used by the discharger to achieve compliance with the conditions of this General Permit and with the requirements of the Storm Water Pollution Prevention Plan (SWPPP). Proper operation and maintenance also includes adequate laboratory controls and appropriate quality assurance procedures. Proper operation and maintenance may require the operation of backup or auxiliary facilities or similar systems installed by a discharger when necessary to achieve compliance with the conditions of this General Permit.

6. Property Rights

This General Permit does not convey any property rights of any sort or any exclusive privileges, nor does it authorize any injury to private property or any invasion of personal rights, nor does it authorize any infringement of Federal, State, or local laws or regulations.

7. Duty to Maintain Records and Provide Information

- a. The LUP discharger shall maintain a paper or electronic copy of all required records, including a copy of this General Permit, for three years from the date generated or date submitted, whichever is last. These records shall be kept at the construction site or in a crew

member's vehicle until construction is completed, and shall be made available upon request.

- b. The LUP discharger shall furnish the Regional Water Board, State Water Board, or USEPA, within a reasonable time, any requested information to determine compliance with this General Permit. The LUP discharger shall also furnish, upon request, copies of records that are required to be kept by this General Permit.

8. Inspection and Entry

The LUP discharger shall allow the Regional Water Board, State Water Board, USEPA, and/or, in the case of construction sites which discharge through a municipal separate storm sewer, an authorized representative of the municipal operator of the separate storm sewer system receiving the discharge, upon the presentation of credentials and other documents as may be required by law, to:

- a. Enter upon the discharger's premises at reasonable times where a regulated construction activity is being conducted or where records must be kept under the conditions of this General Permit;
- b. Access and copy at reasonable times any records that must be kept under the conditions of this General Permit;
- c. Inspect at reasonable times the complete construction site, including any off-site staging areas or material storage areas, and the erosion/sediment controls; and
- d. Sample or monitor at reasonable times for the purpose of ensuring General Permit compliance.

9. Electronic Signature and Certification Requirements

- a. All Permit Registration Documents (PRDs) and Notices of Termination (NOTs) shall be electronically signed, certified, and submitted via SMARTS to the State Water Board. Either the Legally Responsible Person (LRP), as defined in Appendix 5 – Glossary, or a person legally authorized to sign and certify PRDs and NOTs on behalf of the LRP (the LRP's Approved Signatory, as defined in Appendix 5 - Glossary) must submit all information electronically via SMARTS.
- b. Changes to Authorization. If an Approved Signatory's authorization is no longer accurate, a new authorization satisfying the requirements of paragraph (a) of this section must be submitted via SMARTS prior to or

together with any reports, information or applications to be signed by an Approved Signatory.

- c. All SWPPP revisions, annual reports, or other information required by the General Permit (other than PRDs and NOTs) or requested by the Regional Water Board, State Water Board, USEPA, or local storm water management agency shall be certified and submitted by the LRP or the LRP's Approved Signatory.

10. Certification

Any person signing documents under Section E.9 above, shall make the following certification:

"I certify under penalty of law that this document and all attachments were prepared under my direction or supervision in accordance with a system designed to assure that qualified personnel properly gather and evaluate the information submitted. Based on my inquiry of the person or persons who manage the system or those persons directly responsible for gathering the information, to the best of my knowledge and belief, the information submitted is, true, accurate, and complete. I am aware that there are significant penalties for submitting false information, including the possibility of fine and imprisonment for knowing violations."

11. Anticipated Noncompliance

The LUP discharger shall give advance notice to the Regional Water Board and local storm water management agency of any planned changes in the construction activity, which may result in noncompliance with General Permit requirements.

12. Penalties for Falsification of Reports

Section 309(c)(4) of the CWA provides that any person who knowingly makes any false material statement, representation, or certification in any record or other document submitted or required to be maintained under this General Permit, including reports of compliance or noncompliance shall upon conviction, be punished by a fine of not more than \$10,000 or by imprisonment for not more than two years or by both.

13. Oil and Hazardous Substance Liability

Nothing in this General Permit shall be construed to preclude the institution of any legal action or relieve the discharger from any responsibilities, liabilities, or penalties to which the LUP discharger is or may be subject to under Section 311 of the CWA.

14. Severability

The provisions of this General Permit are severable; and, if any provision of this General Permit or the application of any provision of this General Permit to any circumstance is held invalid, the application of such provision to other circumstances and the remainder of this General Permit shall not be affected thereby.

15. Reopener Clause

This General Permit may be modified, revoked and reissued, or terminated for cause due to promulgation of amended regulations, receipt of USEPA guidance concerning regulated activities, judicial decision, or in accordance with 40 Code of Federal Regulations (CFR) 122.62, 122.63, 122.64, and 124.5.

16. Penalties for Violations of Permit Conditions

- a. Section 309 of the CWA provides significant penalties for any person who violates a permit condition implementing Sections 301, 302, 306, 307, 308, 318, or 405 of the CWA or any permit condition or limitation implementing any such section in a permit issued under Section 402. Any person who violates any permit condition of this General Permit is subject to a civil penalty not to exceed \$37,500⁷ per calendar day of such violation, as well as any other appropriate sanction provided by Section 309 of the CWA.
- b. The Porter-Cologne Water Quality Control Act also provides for civil and criminal penalties, which in some cases are greater than those under the CWA.

17. Transfers

This General Permit is not transferable. A new LRP of an ongoing construction activity must submit PRDs in accordance with the requirements of this General Permit to be authorized to discharge under this General Permit. An LRP who is a property owner with active General Permit coverage who sells a fraction or all the land shall inform the new property owner(s) of the requirements of this General Permit.

18. Continuation of Expired Permit

This General Permit continues in force and effect until a new General Permit is issued or the SWRCB rescinds this General Permit. Only those

⁷ May be further adjusted in accordance with the Federal Civil Penalties Inflation Adjustment Act

dischargers authorized to discharge under the expiring General Permit are covered by the continued General Permit.

F. EFFLUENT STANDARDS & RECEIVING WATER MONITORING

1. Narrative Effluent Limitations

- a. LUP dischargers shall ensure that storm water discharges and authorized non-storm water discharges regulated by this General Permit do not contain a hazardous substance equal to or in excess of reportable quantities established in 40 C.F.R. §§ 117.3 and 302.4, unless a separate NPDES Permit has been issued to regulate those discharges.
- b. LUP dischargers shall minimize or prevent pollutants in storm water discharges and authorized non-storm water discharges through the use of structural or non-structural controls, structures, and management practices that achieve BAT for toxic and non-conventional pollutants and BCT for conventional pollutants.

Table 1. Numeric Action Levels, Test Methods, Detection Limits, and Reporting Units

Parameter	Test Method	Discharge Type	Min. Detection Limit	Units	Numeric Action Level
pH	Field test with calibrated portable instrument	LUP Type 2	0.2	pH units	lower NAL = 6.5 upper NAL = 8.5
		LUP Type 3			lower NAL = 6.5 upper NAL = 8.5
Turbidity	EPA 0180.1 and/or field test with calibrated portable instrument	LUP Type 2	1	NTU	250 NTU
		LUP Type 3			250 NTU

2. Numeric Action Levels (NALs)

- a. For LUP Type 2 and 3 dischargers, the lower storm event daily average NAL for pH is 6.5 pH units and the upper storm event daily average NAL for pH is 8.5 pH units. The LUP discharger shall take actions as described below if the storm event daily average discharge is outside of this range of pH values.
- b. For LUP Type 2 and 3 dischargers, the storm event daily average NAL for turbidity is 250 NTU. The discharger shall take actions as described below if the storm event daily average discharge is outside of this range of turbidity values.
- c. Whenever daily average analytical effluent monitoring results indicate that the discharge is below the lower NAL for pH, exceeds the upper NAL for pH, or exceeds the turbidity NAL (as listed in Table 1), the LUP discharger shall conduct a construction site and run-on evaluation to determine whether pollutant source(s) associated with the site's construction activity may have caused or contributed to the NAL exceedance and shall immediately implement corrective actions if they are needed.
- d. The site evaluation will be documented in the SWPPP and specifically address whether the source(s) of the pollutants causing the exceedance of the NAL:
 - i. Are related to the construction activities and whether additional BMPs or SWPPP implementation measures are required to (1) meet BAT/BCT requirements; (2) reduce or prevent pollutants in storm water discharges from causing exceedances of receiving water objectives; and (3) determine what corrective action(s) were taken or will be taken and with a description of the schedule for completion.

AND/OR:

- ii. Are related to the run-on associated with the construction site location and whether additional BMPs or SWPPP implementation measures are required to (1) meet BAT/BCT requirements; (2) reduce or prevent pollutants in storm water discharges from causing exceedances of receiving water objectives; and (3) decide what corrective action(s) were taken or will be taken, including a description of the schedule for completion.

3. Receiving Water Monitoring Triggers

- a. The receiving water monitoring triggers for LUP Type 3 dischargers with direct discharges to surface waters are triggered when the daily average effluent pH values during any site phase when there is a high risk of pH discharge⁸ fall outside of the range of 6.0 and 9.0 pH units, or when the daily average effluent turbidity exceeds 500 NTU.
- b. LUP Type 3 dischargers with direct discharges to surface waters shall conduct receiving water monitoring whenever their effluent monitoring results exceed the receiving water monitoring triggers. If the pH trigger is exceeded, the receiving water shall be monitored for pH for the duration of coverage under this General Permit. If the turbidity trigger is exceeded, the receiving water shall be monitored for turbidity and SSC for the duration of coverage under this General Permit.
- c. LUP Type 3 dischargers with direct discharges to surface waters shall initiate receiving water monitoring when the triggers are exceeded unless the storm event causing the exceedance is determined after the fact to equal to or greater than the 5-year 24-hour storm (expressed in inches of rainfall) as determined by using these maps:

<http://www.wrcc.dri.edu/pcpnfreq/nca5y24.gif>
<http://www.wrcc.dri.edu/pcpnfreq/sca5y24.gif>

 Verification of the 5-year 24-hour storm event shall be done by reporting on-site rain gauge readings as well as nearby governmental rain gauge readings.
- d. If run-on is caused by a forest fire or any other natural disaster, then receiving water monitoring triggers do not apply.

G. RECEIVING WATER LIMITATIONS

1. LUP dischargers shall ensure that storm water discharges and authorized non-storm water discharges to any surface or ground water will not adversely affect human health or the environment.
2. LUP dischargers shall ensure that storm water discharges and authorized non-storm water discharges will not contain pollutants in quantities that threaten to cause pollution or a public nuisance.
3. LUP dischargers shall ensure that storm water discharges and authorized non-storm water discharges will not contain pollutants that cause or

⁸ A period of high risk of pH discharge is defined as a project's complete utilities phase, complete vertical build phase, and any portion of any phase where significant amounts of materials are placed directly on the land at the site in a manner that could result in significant alterations of the background pH of the discharges.

contribute to an exceedance of any applicable water quality objectives or water quality standards (collectively, WQS) contained in a Statewide Water Quality Control Plan, the California Toxics Rule, the National Toxics Rule, or the applicable Regional Water Board's Water Quality Control Plan (Basin Plan).

H. TRAINING QUALIFICATIONS

1. General

All persons responsible for implementing requirements of this General Permit shall be appropriately trained. Training should be both formal and informal, occur on an ongoing basis, and should include training offered by recognized governmental agencies or professional organizations. Persons responsible for preparing, amending and certifying SWPPPs shall comply with the requirements in this Section H.

2. SWPPP Certification Requirements

- a. **Qualified SWPPP Developer:** The LUP discharger shall ensure that all SWPPPs be written, amended and certified by a Qualified SWPPP Developer (QSD). A QSD shall have one of the following registrations or certifications, and appropriate experience, as required for:
 - i A California registered professional civil engineer;
 - ii A California registered professional geologist or engineering geologist;
 - iii A California registered landscape architect;
 - iv A professional hydrologist registered through the American Institute of Hydrology;
 - v A certified professional in erosion and sediment control (CPESC)TM registered through Enviro Cert International, Inc;
 - vi A certified professional in storm water quality (CPSWQ)TM registered through Enviro Cert International, Inc.; or
 - vii A certified professional in erosion and sediment control registered through the National Institute for Certification in Engineering Technologies (NICET).

Effective two years after the adoption date of this General Permit, a QSD shall have attended a State Water Board-sponsored or approved QSD training course.

- b. The LUP discharger shall ensure that the SWPPP is written and amended, as needed, to address the specific circumstances for each construction site covered by this General Permit prior to commencement of construction activity for any stage.
- c. The LUP discharger shall list the name and telephone number of the currently designated Qualified SWPPP Developer(s) in the SWPPP.
- d. **Qualified SWPPP Practitioner:** The LUP discharger shall ensure that all elements of any SWPPP for each project will be implemented by a Qualified SWPPP Practitioner (QSP). A QSP is a person responsible for non-storm water and storm water visual observations, sampling and analysis, and for ensuring full compliance with the permit and implementation of all elements of the SWPPP. Effective two years from the date of adoption of this General Permit, a QSP shall be either a QSD or have one of the following certifications:
 - i. A certified erosion, sediment and storm water inspector registered through Certified Professional in Erosion and Sediment Control, Inc.; or
 - ii. A certified inspector of sediment and erosion control registered through Certified Inspector of Sediment and Erosion Control, Inc.

Effective two years after the adoption date of this General Permit, a QSP shall have attended a State Water Board-sponsored or approved QSP training course.

- e. The LUP discharger shall ensure that the SWPPP include a list of names of all contractors, subcontractors, and individuals who will be directed by the Qualified SWPPP Practitioner, and who is ultimately responsible for implementation of the SWPPP. This list shall include telephone numbers and work addresses. Specific areas of responsibility of each subcontractor and emergency contact numbers shall also be included.
- f. The LUP discharger shall ensure that the SWPPP and each amendment be signed by the Qualified SWPPP Developer. The LUP discharger shall include a listing of the date of initial preparation and the dates of each amendment in the SWPPP.

I. TYPES OF LINEAR PROJECTS

This attachment establishes three types (Type 1, 2 & 3) of complexity for areas within an LUP or project section based on threat to water quality. Project area Types are determined through Attachment A.1.

The Type 1 requirements below establish the baseline requirements for all LUPs subject to this General Permit. Additional requirements for Type 2 and Type 3 LUPs are labeled.

1. Type 1 LUPs:

LUP dischargers with areas of a LUP designated as Type 1 shall comply with the requirements in this Attachment. Type 1 LUPs are:

- a. Those construction areas where 70 percent or more of the construction activity occurs on a paved surface and where areas disturbed during construction will be returned to preconstruction conditions or equivalent protection established at the end of the construction activities for the day; or
- b. Where greater than 30 percent of construction activities occur within the non-paved shoulders or land immediately adjacent to paved surfaces, or where construction occurs on unpaved improved roads, including their shoulders or land immediately adjacent to them where:
 - i. Areas disturbed during construction will be returned to preconstruction conditions or equivalent protection is established at the end of the construction activities for the day to minimize the potential for erosion and sediment deposition, and
 - ii. Areas where established vegetation was disturbed during construction will be stabilized and re-vegetated by the end of project. When required, adequate temporary stabilization BMPs will be installed and maintained until vegetation is established to meet minimum cover requirements established in this General Permit for final stabilization.
- c. Where the risk determination is as follows:
 - i. Low sediment risk, low receiving water risk, or
 - ii. Low sediment risk, medium receiving water risk, or
 - iii. Medium sediment risk, low receiving water risk

2. Type 2 LUPs:

Type 2 LUPs are determined by the Combined Risk Matrix in Attachment A.1. Type 2 LUPs have the specified combination of risk:

- d. High sediment risk, low receiving water risk, or
- e. Medium sediment risk, medium receiving water risk, or
- f. Low sediment risk, high receiving water risk

Receiving water risk is either considered “Low” for those areas of the project that are not in close proximity to a sensitive receiving watershed, “Medium” for those areas of the project within a sensitive receiving watershed yet outside of the flood plain of a sensitive receiving water body, and “High” where the soil disturbance is within close proximity to a sensitive receiving water body. Project sediment risk is calculated based on the Risk Factor Worksheet in Attachment C of this General Permit.

3. Type 3 LUPs:

Type 3 LUPs are determined by the Combined Risk Matrix in Attachment A.1. Type 3 LUPs have the specified combination of risk:

- a. High sediment risk, high receiving water risk, or
- b. High sediment risk, medium receiving water risk, or
- c. Medium sediment risk, high receiving water risk

Receiving water risk is either considered “Medium” for those areas of the project within a sensitive receiving watershed yet outside of the flood plain of a sensitive receiving water body, or “High” where the soil disturbance is within close proximity to a sensitive receiving water body. Project sediment risk is calculated based on the Risk Factor Worksheet in Attachment C.

J. LUP TYPE-SPECIFIC REQUIREMENTS**1. Effluent Standards**

- a. Narrative – LUP dischargers shall comply with the narrative effluent standards below.

- i Storm water discharges and authorized non-storm water discharges regulated by this General Permit shall not contain a hazardous substance equal to or in excess of reportable quantities established in 40 C.F.R. §§ 117.3 and 302.4, unless a separate NPDES Permit has been issued to regulate those discharges.
 - ii LUP dischargers shall minimize or prevent pollutants in storm water discharges and authorized non-storm water discharges through the use of controls, structures, and management practices that achieve BAT for toxic and non-conventional pollutants and BCT for conventional pollutants.
- b. Numeric – LUP Type 1 dischargers are not subject to a numeric effluent standard
 - c. Numeric –LUP Type 2 dischargers are subject to a pH NAL of 6.5-8.5, and a turbidity NAL of 250 NTU.
 - d. Numeric – LUP Type 3 dischargers are subject to a pH NAL of 6.5-8.5, and a turbidity NAL of 250 NTU.

2. Good Site Management "Housekeeping"

- a. LUP dischargers shall implement good site management (i.e., "housekeeping") measures for construction materials that could potentially be a threat to water quality if discharged. At a minimum, the good housekeeping measures shall consist of the following:
 - i Identify the products used and/or expected to be used and the end products that are produced and/or expected to be produced. This does not include materials and equipment that are designed to be outdoors and exposed to environmental conditions (i.e. poles, equipment pads, cabinets, conductors, insulators, bricks, etc.).
 - ii Cover and berm loose stockpiled construction materials that are not actively being used (i.e. soil, spoils, aggregate, fly-ash, stucco, hydrated lime, etc.).
 - iii Store chemicals in watertight containers (with appropriate secondary containment to prevent any spillage or leakage) or in a storage shed (completely enclosed).
 - iv Minimize exposure of construction materials to precipitation (not applicable to materials designed to be outdoors and exposed to the environment).

- v Implement BMPs to control the off-site tracking of loose construction and landscape materials.
- b. LUP dischargers shall implement good housekeeping measures for waste management, which, at a minimum, shall consist of the following:
 - i Prevent disposal of any rinse or wash waters or materials on impervious or pervious site surfaces or into the storm drain system.
 - ii Ensure the containment of sanitation facilities (e.g., portable toilets) to prevent discharges of pollutants to the storm water drainage system or receiving water.
 - iii Clean or replace sanitation facilities and inspecting them regularly for leaks and spills.
 - iv Cover waste disposal containers at the end of every business day and during a rain event.
 - v Prevent discharges from waste disposal containers to the storm water drainage system or receiving water.
 - vi Contain and securely protect stockpiled waste material from wind and rain at all times unless actively being used.
 - vii Implement procedures that effectively address hazardous and non-hazardous spills.
 - viii Develop a spill response and implementation element of the SWPPP prior to commencement of construction activities. The SWPPP shall require that:
 - (1) Equipment and materials for cleanup of spills shall be available on site and that spills and leaks shall be cleaned up immediately and disposed of properly; and
 - (2) Appropriate spill response personnel are assigned and trained.
 - ix Ensure the containment of concrete washout areas and other washout areas that may contain additional pollutants so there is no discharge into the underlying soil and onto the surrounding areas.

- c. LUP dischargers shall implement good housekeeping for vehicle storage and maintenance, which, at a minimum, shall consist of the following:
 - i. Prevent oil, grease, or fuel from leaking into the ground, storm drains or surface waters.
 - ii. Implement appropriate BMPs whenever equipment or vehicles are fueled, maintained or stored.
 - iii. Clean leaks immediately and disposing of leaked materials properly.

- d. LUP dischargers shall implement good housekeeping for landscape materials, which, at a minimum, shall consist of the following:
 - i. Contain stockpiled materials such as mulches and topsoil when they are not actively being used.
 - ii. Contain fertilizers and other landscape materials when they are not actively being used.
 - iii. Discontinue the application of any erodible landscape material at least 2 days before a forecasted rain event⁹ or during periods of precipitation.
 - iv. Applying erodible landscape material at quantities and application rates according to manufacture recommendations or based on written specifications by knowledgeable and experienced field personnel.
 - v. Stacking erodible landscape material on pallets and covering or storing such materials when not being used or applied.

- e. LUP dischargers shall conduct an assessment and create a list of potential pollutant sources and identify any areas of the site where additional BMPs are necessary to reduce or prevent pollutants in storm water discharges and authorized non-storm water discharges. This potential pollutant list shall be kept with the SWPPP and shall identify all non-visible pollutants which are known, or should be known, to occur on the construction site. At a minimum, when developing BMPs, LUP dischargers shall do the following:

⁹ 50% or greater chance of producing precipitation.

- i Consider the quantity, physical characteristics (e.g., liquid, powder, solid), and locations of each potential pollutant source handled, produced, stored, recycled, or disposed of at the site.
 - ii Consider the degree to which pollutants associated with those materials may be exposed to and mobilized by contact with storm water.
 - iii Consider the direct and indirect pathways that pollutants may be exposed to storm water or authorized non-storm water discharges. This shall include an assessment of past spills or leaks, non-storm water discharges, and discharges from adjoining areas.
 - iv Ensure retention of sampling, visual observation, and inspection records.
 - v Ensure effectiveness of existing BMPs to reduce or prevent pollutants in storm water discharges and authorized non-storm water discharges.
- f. LUP dischargers shall implement good housekeeping measures on the construction site to control the air deposition of site materials and from site operations.

3. Non-Storm Water Management

- a. LUP dischargers shall implement measures to control all non-storm water discharges during construction.
- b. LUP dischargers shall wash vehicles in such a manner as to prevent non-storm water discharges to surface waters or MS4 drainage systems.
- c. LUP dischargers shall clean streets in such a manner as to prevent unauthorized non-storm water discharges from reaching surface water or MS4 drainage systems.

4. Erosion Control

- a. LUP dischargers shall implement effective wind erosion control.
- b. LUP dischargers shall provide effective soil cover for inactive¹⁰ areas and all finished slopes, and utility backfill.

¹⁰ Areas of construction activity that have been disturbed and are not scheduled to be re-disturbed for at least 14 days

- c. LUP dischargers shall limit the use of plastic materials when more sustainable, environmentally friendly alternatives exist. Where plastic materials are deemed necessary, the discharger shall consider the use of plastic materials resistant to solar degradation.

5. Sediment Controls

- a. LUP dischargers shall establish and maintain effective perimeter controls as needed, and implement effective BMPs for all construction entrances and exits to sufficiently control erosion and sediment discharges from the site.
- b. On sites where sediment basins are to be used, LUP dischargers shall, at minimum, design sediment basins according to the guidance provided in CASQA’s Construction BMP Handbook.
- c. **Additional LUP Type 2 & 3 Requirement:** LUP Type 2 & 3 dischargers shall apply linear sediment controls along the toe of the slope, face of the slope, and at the grade breaks of exposed slopes to comply with sheet flow lengths¹¹ in accordance with Table 2 below.

Table 2 – Critical Slope/Sheet Flow Length Combinations

Slope Percentage	Sheet flow length not to exceed
0-25%	20 feet
25-50%	15 feet
Over 50%	10 feet

- d. **Additional LUP Type 2 & 3 Requirement:** LUP Type 2 & 3 dischargers shall ensure that construction activity traffic to and from the project is limited to entrances and exits that employ effective controls to prevent off-site tracking of sediment.
- e. **Additional LUP Type 2 & 3 Requirement:** LUP Type 2 & 3 dischargers shall ensure that all storm drain inlets and perimeter controls, runoff control BMPs, and pollutant controls at entrances and exits (e.g. tire washoff locations) are maintained and protected from activities that reduce their effectiveness.
- f. **Additional LUP Type 2 & 3 Requirement:** LUP Type 2 & 3 dischargers shall inspect all immediate access roads. At a minimum daily and prior to any rain event, the discharger shall remove any

¹¹ Sheet flow length is the length that shallow, low velocity flow travels across a site.

sediment or other construction activity-related materials that are deposited on the roads (by vacuuming or sweeping).

- g. **Additional LUP Type 3 Requirement:** The Regional Water Board may require LUP Type 3 dischargers to implement additional site-specific sediment control requirements if the implementation of the other requirements in this section are not adequately protecting the receiving waters.

6. Run-on and Run-off Controls

- a. LUP dischargers shall effectively manage all run-on, all runoff within the site and all runoff that discharges off the site. Run-on from off site shall be directed away from all disturbed areas or shall collectively be in compliance with the effluent limitations in this Attachment.
- b. Run-on and runoff controls are not required for Type 1 LUPs unless the evaluation of quantity and quality of run-on and runoff deems them necessary or visual inspections show that the site requires such controls.

7. Inspection, Maintenance and Repair

- a. All inspection, maintenance repair and sampling activities at the discharger's LUP location shall be performed or supervised by a QSP representing the discharger. The QSP may delegate any or all of these activities to an employee trained to do the task(s) appropriately, but shall ensure adequate deployment.
- b. LUP dischargers shall conduct visual inspections and observations daily during working hours (not recorded). At least once each 24-hour period during extended storm events, **LUP Type 2 & 3 dischargers** shall conduct visual inspections to identify and record BMPs that need maintenance to operate effectively, that have failed, or that could fail to operate as intended. Inspectors shall be the QSP or be trained by the QSP.
- c. Upon identifying failures or other shortcomings, as directed by the QSP, LUP dischargers shall begin implementing repairs or design changes to BMPs within 72 hours of identification and complete the changes as soon as possible.
- d. For each pre- and post-rain event inspection required, LUP dischargers shall complete an inspection checklist, using a form provided by the State Water Board or Regional Water Board or in an alternative format that includes the information described below.

- e. The LUP discharger shall ensure that the checklist remains on-site or with the SWPPP. At a minimum, an inspection checklist should include:
 - i Inspection date and date the inspection report was written.
 - ii Weather information, including presence or absence of precipitation, estimate of beginning of qualifying storm event, duration of event, time elapsed since last storm, and approximate amount of rainfall in inches.
 - iii Site information, including stage of construction, activities completed, and approximate area of the site exposed.
 - iv A description of any BMPs evaluated and any deficiencies noted.
 - v If the construction site is safely accessible during inclement weather, list the observations of all BMPs: erosion controls, sediment controls, chemical and waste controls, and non-storm water controls. Otherwise, list the results of visual inspections at all relevant outfalls, discharge points, downstream locations and any projected maintenance activities.
 - vi Report the presence of noticeable odors or of any visible sheen on the surface of any discharges.
 - vii Any corrective actions required, including any necessary changes to the SWPPP and the associated implementation dates.
 - viii Photographs taken during the inspection, if any.
 - ix Inspector's name, title, and signature.

K. STORM WATER POLLUTION PREVENTION PLAN (SWPPP) REQUIREMENTS

1. Objectives

SWPPPs for all LUPs shall be developed and amended or revised by a QSD. The SWPPP shall be designed to address the following objectives:

- a. All pollutants and their sources, including sources of sediment, associated with construction activities associated with LUP activity are controlled;
- b. All non-storm water discharges are identified and either eliminated, controlled, or treated;
- c. BMPs are effective and result in the reduction or elimination of pollutants in storm water discharges and authorized non-storm water discharges from LUPs during construction; and
- d. Stabilization BMPs installed to reduce or eliminate pollutants after construction is completed are effective and maintained.

2. SWPPP Implementation Schedule

- a. LUPs for which PRDs have been submitted to the State Water Board shall develop a site/project location SWPPP prior to the start of land-disturbing activity in accordance with this Section and shall implement the SWPPP concurrently with commencement of soil-disturbing activities.
- b. For an ongoing LUP involving a change in the LRP, the new LRP shall review the existing SWPPP and amend it, if necessary, or develop a new SWPPP within 15 calendar days to conform to the requirements set forth in this General Permit.

3. Availability

The SWPPP shall be available at the construction site during working hours while construction is occurring and shall be made available upon request by a State or Municipal inspector. When the original SWPPP is retained by a crewmember in a construction vehicle and is not currently at the construction site, copies of the BMPs and map/drawing will be left with the field crew and the original SWPPP shall be made available via a request by radio/telephone.

L. REGIONAL WATER BOARD AUTHORITIES

1. Regional Water Boards shall administer the provisions of this General Permit. Administration of this General Permit may include, but is not limited to, requesting the submittal of SWPPPs, reviewing SWPPPs, reviewing monitoring and sampling and analysis reports, conducting compliance inspections, gathering site information by any medium including sampling, photo and video documentation, and taking enforcement actions.
2. Regional Water Boards may terminate coverage under this General Permit for dischargers who fail to comply with its requirements or where they determine that an individual NPDES permit is appropriate.
3. Regional Water Boards may issue separate permits for discharges of storm water associated with construction activity to individual dischargers, categories of dischargers, or dischargers in a geographic area. Upon issuance of such permits by a Regional Water Board, dischargers subject to those permits shall no longer be regulated by this General Permit.
4. Regional Water Boards may direct the discharger to reevaluate the LUP Type(s) for the project (or elements/areas of the project) and impose the appropriate level of requirements.
5. Regional Water Boards may terminate coverage under this General Permit for dischargers who negligently or with willful intent incorrectly determine or report their LUP Type (e.g., they determine themselves to be a LUP Type 1 when they are actually a Type 2).
6. Regional Water Boards may review PRDs and reject or accept applications for permit coverage or may require dischargers to submit a Report of Waste Discharge / NPDES permit application for Regional Water Board consideration of individual requirements.
7. Regional Water Boards may impose additional requirements on dischargers to satisfy TMDL implementation requirements or to satisfy provisions in their Basin Plans.
8. Regional Water Boards may require additional Monitoring and Reporting Program Requirements, including sampling and analysis of discharges to sediment-impaired water bodies.
9. Regional Water Boards may require dischargers to retain records for more than the three years required by this General Permit.

- 10.** Based on an LUP's threat to water quality and complexity, the Regional Water Board may determine on a case-by-case basis that an LUP, or a portion of an LUP, is not eligible for the linear project requirements contained in this Attachment, and require that the discharger comply with all standard requirements in this General Permit.

- 11.** The Regional Water Board may require additional monitoring and reporting program requirements including sampling and analysis of discharges to CWA § 303(d)-listed water bodies. Additional requirements imposed by the Regional Water Board shall be consistent with the overall monitoring effort in the receiving waters.

M. MONITORING AND REPORTING REQUIREMENTS

Table 3. LUP Summary of Monitoring Requirements

LUP Type	Visual Inspections				Sample Collection		
	Daily Site BMP	Pre-storm Event	Daily Storm BMP	Post Storm	Storm Water Discharge	Receiving Water	Non-Visible (when applicable)
		Baseline					
1	X						X
2	X	X	X	X	X		X
3	X	X	X	X	X	X	X

1. Objectives

LUP dischargers shall prepare a monitoring and reporting program (M&RP) prior to the start of construction and immediately implement the program at the start of construction for LUPs. The monitoring program must be implemented at the appropriate level to protect water quality at all times throughout the life of the project. The M&RP must be a part of the SWPPP, included as an appendix or separate SWPPP chapter.

2. M&RP Implementation Schedule

- a. LUP dischargers shall implement the requirements of this Section at the time of commencement of construction activity. LUP dischargers are responsible for implementing these requirements until construction activity is complete and the site is stabilized.
- b. LUP dischargers shall revise the M&RP when:
 - i. Site conditions or construction activities change such that a change in monitoring is required to comply with the requirements and intent of this General Permit.
 - ii. The Regional Water Board requires the discharger to revise its M&RP based on its review of the document. Revisions may include, but not be limited to, conducting additional site inspections, submitting reports, and certifications. Revisions shall be submitted via postal mail or electronic e-mail.

- iii The Regional Water Board may require additional monitoring and reporting program requirements including sampling and analysis of discharges to CWA § 303(d)-listed water bodies. Additional requirements imposed by the Regional Water Board shall be consistent with the overall monitoring effort in the receiving waters.

3. LUP Type 1 Monitoring and Reporting Requirements

a. LUP Type 1 Inspection Requirements

- i LUP Type 1 dischargers shall ensure that all inspections are conducted by trained personnel. The name(s) and contact number(s) of the assigned inspection personnel should be listed in the SWPPP.
- ii LUP Type 1 dischargers shall ensure that all visual inspections are conducted daily during working hours and in conjunction with other daily activities in areas where active construction is occurring.
- iii LUP Type 1 dischargers shall ensure that photographs of the site taken before, during, and after storm events are taken during inspections, and submitted through the State Water Board's SMARTS website once every three rain events.
- iv LUP Type 1 dischargers shall conduct daily visual inspections to verify that:
 - (1) Appropriate BMPs for storm water and non-storm water are being implemented in areas where active construction is occurring (including staging areas);
 - (2) Project excavations are closed, with properly protected spoils, and that road surfaces are cleaned of excavated material and construction materials such as chemicals by either removing or storing the material in protective storage containers at the end of every construction day;
 - (3) Land areas disturbed during construction are returned to pre-construction conditions or an equivalent protection is used at the end of each workday to eliminate or minimize erosion and the possible discharge of sediment or other pollutants during a rain event.
- v Inspections may be discontinued in non-active construction areas where soil-disturbing activities are completed and final soil stabilization is achieved (e.g., paving is completed, substructures

are installed, vegetation meets minimum cover requirements for final stabilization, or other stabilization requirements are met).

- vi Inspection programs are required for LUP Type 1 projects where temporary and permanent stabilization BMPs are installed and are to be monitored after active construction is completed. Inspection activities shall continue until adequate permanent stabilization is established and, in areas where re-vegetation is chosen, until minimum vegetative coverage is established in accordance with Section C.1 of this Attachment.

b. LUP Type 1 Monitoring Requirements for Non-Visible Pollutants

LUP Type 1 dischargers shall implement sampling and analysis requirements to monitor non-visible pollutants associated with (1) construction sites; (2) activities producing pollutants that are not visually detectable in storm water discharges; and (3) activities which could cause or contribute to an exceedance of water quality objectives in the receiving waters.

- i Sampling and analysis for non-visible pollutants is only required where the LUP Type 1 discharger believes pollutants associated with construction activities have the potential to be discharged with storm water runoff due to a spill or in the event there was a breach, malfunction, failure and/or leak of any BMP. Also, failure to implement BMPs may require sample collection.
 - (1) Visual observations made during the monitoring program described above will help the LUP Type 1 discharger determine when to collect samples.
 - (2) The LUP Type 1 discharger is not required to sample if one of the conditions described above (e.g., breach or spill) occurs and the site is cleaned of material and pollutants and/or BMPs are implemented prior to the next storm event.
- ii LUP Type 1 dischargers shall collect samples down-gradient from all discharge locations where the visual observations were made triggering the monitoring, and which can be safely accessed. For sites where sampling and analysis is required, personnel trained in water quality sampling procedures shall collect storm water samples.
- iii If sampling for non-visible pollutant parameters is required, LUP Type 1 dischargers shall ensure that samples be analyzed for parameters indicating the presence of pollutants identified in the pollutant source assessment required in Section J.2.a.i.

- iv LUP Type 1 dischargers shall collect samples during the first two hours of discharge from rain events that occur during business hours and which generate runoff.
 - v LUP Type 1 dischargers shall ensure that a sufficiently large sample of storm water that has not come into contact with the disturbed soil or the materials stored or used on-site (uncontaminated sample¹²) will be collected for comparison with the discharge sample. Samples shall be collected during the first two hours of discharge from rain events that occur during daylight hours and which generate runoff.
 - vi LUP Type 1 dischargers shall compare the uncontaminated sample to the samples of discharge using field analysis or through laboratory analysis. Analyses may include, but are not limited to, indicator parameters such as: pH, specific conductance, dissolved oxygen, conductivity, salinity, and Total Dissolved Solids (TDS).
 - vii For laboratory analyses, all sampling, sample preservation, and other analyses must be conducted according to test procedures pursuant to 40 C.F.R. Part 136. LUP Type 1 dischargers shall ensure that field samples are collected and analyzed according to manufacturer specifications of the sampling devices employed. Portable meters shall be calibrated according to manufacturer's specification.
 - viii LUP Type 1 dischargers shall ensure that all field and/or analytical data are kept in the SWPPP document.
- c. LUP Type 1 Visual Observation Exceptions
- i LUP Type 1 dischargers shall be prepared to collect samples and conduct visual observation (inspections) to meet the minimum visual observation requirements of this Attachment. The Type 1 LUP discharger is not required to physically collect samples or conduct visual observation (inspections) under the following conditions:
 - (1) During dangerous weather conditions such as flooding and electrical storms;
 - (2) Outside of scheduled site business hours.
 - (3) When access to the site is unsafe due to storm events.

¹² Sample collected at a location unaffected by construction activities.

- ii If the LUP Type 1 discharger does not collect the required samples or visual observation (inspections) due to these exceptions, an explanation why the sampling or visual observation (inspections) were not conducted shall be included in both the SWPPP and the Annual Report.
- d. Particle Size Analysis for Risk Justification

LUP Type 1 dischargers utilizing justifying an alternative project risk shall report a soil particle size analysis used to determine the RUSLE K-Factor. ASTM D-422 (Standard Test Method for Particle-Size Analysis of Soils), as revised, shall be used to determine the percentages of sand, very fine sand, silt, and clay on the site.

4. LUP Type 2 & 3 Monitoring and Reporting Requirements

- a. LUP Type 2 & 3 Inspection Requirements
- i LUP Type 2 & 3 dischargers shall ensure that all inspections are conducted by trained personnel. The name(s) and contact number(s) of the assigned inspection personnel should be listed in the SWPPP.
 - ii LUP Type 2 & 3 dischargers shall ensure that all visual inspections are conducted daily during working hours and in conjunction with other daily activities in areas where active construction is occurring.
 - iii LUP Type 2 & 3 dischargers shall ensure that photographs of the site taken before, during, and after storm events are taken during inspections, and submitted through the State Water Board's SMARTS website once every three rain events.
 - iv LUP Type 2 & 3 dischargers shall conduct daily visual inspections to verify that appropriate BMPs for storm water and non-storm water are being implemented and in place in areas where active construction is occurring (including staging areas).
 - v LUP Type 2 & 3 dischargers shall conduct inspections of the construction site prior to anticipated storm events, during extended storm events, and after actual storm events to identify areas contributing to a discharge of storm water associated with construction activity. Pre-storm inspections are to ensure that BMPs are properly installed and maintained; post-storm inspections are to assure that BMPs have functioned adequately. During

extended storm events, inspections shall be required during normal working hours for each 24-hour period.

- vi Inspections may be discontinued in non-active construction areas where soil-disturbing activities are completed and final soil stabilization is achieved (e.g., paving is completed, substructures are installed, vegetation meets minimum cover requirements for final stabilization, or other stabilization requirements are met).
- vii LUP Type 2 & 3 dischargers shall implement a monitoring program for inspecting projects that require temporary and permanent stabilization BMPs after active construction is complete. Inspections shall ensure that the BMPs are adequate and maintained. Inspection activities shall continue until adequate permanent stabilization is established and, in vegetated areas, until minimum vegetative coverage is established in accordance with Section C.1 of this Attachment.
- viii If possible, LUP Type 2 & 3 dischargers shall install a rain gauge on-site at an accessible and secure location with readings made during all storm event inspections. When readings are unavailable, data from the closest rain gauge with publically available data may be used.
- ix LUP Type 2 & 3 dischargers shall include and maintain a log of the inspections conducted in the SWPPP. The log will provide the date and time of the inspection and who conducted the inspection.

b. LUP Type 2 & 3 Storm Water Effluent Monitoring Requirements

Table 4. LUP Type 2 & 3 Effluent Monitoring Requirements

LUP Type	Frequency	Effluent Monitoring
2	Minimum of 3 samples per day characterizing discharges associated with construction activity from the project active areas of construction.	Turbidity, pH, and non-visible pollutant parameters (if applicable)
3	Minimum of 3 samples per day characterizing discharges associated with construction activity from the project active areas of construction.	turbidity, pH, and non-visible pollutant parameters (if applicable)

- i LUP Type 2 & 3 dischargers shall collect storm water grab samples from sampling locations characterizing discharges associated with activity from the LUP active areas of construction. At a minimum, 3 samples shall be collected per day of discharge.

- ii LUP Type 2 & 3 dischargers shall collect samples of stored or contained storm water that is discharged subsequent to a storm event producing precipitation of ½ inch or more at the time of discharge.
 - iii LUP Type 2 & 3 dischargers shall ensure that storm water grab sample(s) obtained be representative of the flow and characteristics of the discharge.
 - iv LUP Type 2 & 3 dischargers shall analyze their effluent samples for:
 - (1) pH and turbidity
 - (2) Any additional parameter for which monitoring is required by the Regional Water Board.
- c. LUP Type 2 & 3 Storm Water Effluent Sampling Locations
- i LUP Type 2 & 3 dischargers shall perform sampling and analysis of storm water discharges to characterize discharges associated with construction activity from the entire disturbed project or area.
 - ii LUP Type 2 & 3 dischargers may monitor and report run-on from surrounding areas if there is reason to believe run-on may contribute to exceedance of NALs.
 - iii LUP Type 2 & 3 dischargers shall select analytical test methods from the list provided in Table 5 below.
 - iv LUP Type 2 & 3 dischargers shall ensure that all storm water sample collection preservation and handling shall be conducted in accordance with the “Storm Water Sample Collection and Handling Instructions” below.
- d. LUP Type 3 Receiving Water Monitoring Requirements
- i In the event that an LUP Type 3 discharger’s effluent exceeds the receiving water monitoring triggers of 500 NTU turbidity or pH range of 6.0-9.0, contained in this General Permit and has a direct discharge to receiving waters, the LUP discharger shall subsequently sample Receiving Waters (RWs) for turbidity, pH (if applicable) and SSC for the duration of coverage under this General Permit. In the event that an LUP Tupe 3 discharger utilizing ATS with direct discharges into receiving waters discharges effluent that exceeds the NELs in this permit, the discharger shall

subsequently sample RWs for turbidity, pH (if applicable), and SSC for the duration of coverage under this General Permit.

- ii LUP Type 3 dischargers that meet the project criteria in Appendix 3 of this General Permit and have more than 30 acres of soil disturbance in the project area or project section area designated as Type 3, shall comply with the Bioassessment requirements prior to commencement of construction activity.
 - iii LUP Type 3 dischargers shall obtain RW samples in accordance with the requirements of the Receiving Water Sampling Locations section (Section M.4.c. of this Attachment).
- e. LUP Type 3 Receiving Water Sampling Locations
- i **Upstream/up-gradient RW samples:** LUP Type 3 dischargers shall obtain any required upstream/up-gradient receiving water samples from a representative and accessible location as close as possible to and upstream from the effluent discharge point.
 - ii **Downstream/down-gradient RW samples:** LUP Type 3 dischargers shall obtain any required downstream/down-gradient receiving water samples from a representative and accessible location as close as possible to and downstream from the effluent discharge point.
 - iii If two or more discharge locations discharge to the same receiving water, LUP Type 3 dischargers may sample the receiving water at a single upstream and downstream location.

f. LUP Type 2 & 3 Monitoring Requirements for Non-Visible Pollutants

LUP Type 2 & 3 dischargers shall implement sampling and analysis requirements to monitor non-visible pollutants associated with (1) construction sites; (2) activities producing pollutants that are not visually detectable in storm water discharges; and (3) activities which could cause or contribute to an exceedance of water quality objectives in the receiving waters.

- i Sampling and analysis for non-visible pollutants is only required where LUP Type 2 & 3 dischargers believe pollutants associated with construction activities have the potential to be discharged with storm water runoff due to a spill or in the event there was a breach, malfunction, failure and/or leak of any BMP. Also, failure to implement BMPs may require sample collection.

- (1) Visual observations made during the monitoring program described above will help LUP Type 2 & 3 dischargers determine when to collect samples.
 - (2) LUP Type 2 & 3 dischargers are not required to sample if one of the conditions described above (e.g., breach or spill) occurs and the site is cleaned of material and pollutants and/or BMPs are implemented prior to the next storm event.
- ii LUP Type 2 & 3 dischargers shall collect samples down-gradient from the discharge locations where the visual observations were made triggering the monitoring and which can be safely accessed. For sites where sampling and analysis is required, personnel trained in water quality sampling procedures shall collect storm water samples.
 - iii If sampling for non-visible pollutant parameters is required, LUP Type 2 & 3 dischargers shall ensure that samples be analyzed for parameters indicating the presence of pollutants identified in the pollutant source assessment required in Section J.2.a.i.
 - iv LUP Type 2 & 3 dischargers shall collect samples during the first two hours of discharge from rain events that occur during business hours and which generate runoff.
 - v LUP Type 2 & 3 dischargers shall ensure that a sufficiently large sample of storm water that has not come into contact with the disturbed soil or the materials stored or used on-site (uncontaminated sample¹³) will be collected for comparison with the discharge sample. Samples shall be collected during the first two hours of discharge from rain events that occur during daylight hours and which generate runoff.
 - vi LUP Type 2 & 3 dischargers shall compare the uncontaminated sample to the samples of discharge using field analysis or through laboratory analysis. Analyses may include, but are not limited to, indicator parameters such as: pH, specific conductance, dissolved oxygen, conductivity, salinity, and Total Dissolved Solids (TDS).
 - vii For laboratory analyses, all sampling, sample preservation, and other analyses must be conducted according to test procedures pursuant to 40 C.F.R. Part 136. LUP Type 2 & 3 dischargers shall ensure that field samples are collected and analyzed according to manufacturer specifications of the sampling devices employed.

¹³ Sample collected at a location unaffected by construction activities

Portable meters shall be calibrated according to manufacturer's specification.

viii LUP Type 2 & 3 dischargers shall ensure that all field and/or analytical data are kept in the SWPPP document.

g. LUP Type 2 & 3 Visual Observation and Sample Collection Exceptions

i LUP Type 2 & 3 dischargers shall be prepared to collect samples and conduct visual observation (inspections) to meet the minimum visual observation requirements of this Attachment. Type 2 & 3 LUP dischargers are not required to physically collect samples or conduct visual observation (inspections) under the following conditions:

(1) During dangerous weather conditions such as flooding and electrical storms;

(2) Outside of scheduled site business hours.

(3) When access to the site is unsafe due to storm events.

ii If the LUP Type 2 or 3 discharger does not collect the required samples or visual observation (inspections) due to these exceptions, an explanation why the sampling or visual observation (inspections) were not conducted shall be included in both the SWPPP and the Annual Report.

h. LUP Type 2 & 3 Storm Water Sample Collection and Handling Instructions

LUP Type 2 & 3 dischargers shall refer to Table 5 below for test Methods, detection Limits, and reporting Units. During storm water sample collection and handling, the LUP Type 2 & 3 discharger shall:

i Identify the parameters required for testing and the number of storm water discharge points that will be sampled. Request the laboratory to provide the appropriate number of sample containers, types of containers, sample container labels, blank chain of custody forms, and sample preservation instructions.

ii Determine how to ship the samples to the laboratory. The testing laboratory should receive samples within 48 hours of the physical sampling (unless otherwise required by the laboratory). The options are to either deliver the samples to the laboratory, arrange to have the laboratory pick them up, or ship them overnight to the laboratory.

- iii Use only the sample containers provided by the laboratory to collect and store samples. Use of any other type of containers could contaminate your samples.
- iv Prevent sample contamination, by not touching, or putting anything into the sample containers before collecting storm water samples.
- v Not overfilling sample containers. Overfilling can change the analytical results.
- vi Tightly screw the cap of each sample container without stripping the threads of the cap.
- vii Complete and attach a label to each sample container. The label shall identify the date and time of sample collection, the person taking the sample, and the sample collection location or discharge point. The label should also identify any sample containers that have been preserved.
- viii Carefully pack sample containers into an ice chest or refrigerator to prevent breakage and maintain temperature during shipment. Remember to place frozen ice packs into the shipping container. Samples should be kept as close to 4° C (39° F) as possible until arriving at the laboratory. Do not freeze samples.
- ix Complete a Chain of Custody form for each set of samples. The Chain of Custody form shall include the discharger's name, address, and phone number, identification of each sample container and sample collection point, person collecting the samples, the date and time each sample container was filled, and the analysis that is required for each sample container.
- x Upon shipping/delivering the sample containers, obtain both the signatures of the persons relinquishing and receiving the sample containers.
- xi Designate and train personnel to collect, maintain, and ship samples in accordance with the above sample protocols and good laboratory practices.
- xii Refer to the Surface Water Ambient Monitoring Program's (SWAMP) 2008 Quality Assurance Program Plan (QAPrP) for more

information on sampling collection and analysis. See http://www.waterboards.ca.gov/water_issues/programs/swamp/¹⁴

Table 5. Test Methods, Detection Limits, Reporting Units and Applicable NALs

Parameter	Test Method	Discharge Type	Min. Detection Limit	Reporting Units	Numeric Action Levels	(LUP Type 3) Receiving Water Monitoring Trigger
pH	Field test with calibrated portable instrument	Type 2 & 3	0.2	pH units	Lower = 6.5 upper = 8.5	Lower = 6.0 upper = 9.0
Turbidity	EPA 0180.1 and/or field test with calibrated portable instrument	Type 2 & 3	1	NTU	250 NTU	500 NTU
SSC	ASTM Method D 3977-97 ¹⁵	Type 3 if Receiving Water Monitoring Trigger is exceeded	5	Mg/L	N/A	N/A
Bioassessment	(STE) Level I of (SAFIT), ¹⁶ fixed-count of 600 org/sample	Type 3 LUPs > 30 acres	N/A	N/A	N/A	N/A

i. LUP Type 2 & 3 Monitoring Methods

i The LUP Type 2 or 3 discharger’s project M&RP shall include a description of the following items:

- (1) Visual observation locations, visual observation procedures, and visual observation follow-up and tracking procedures.

¹⁴ Additional information regarding SWAMP’s QAPrP can be found at: http://www.waterboards.ca.gov/water_issues/programs/swamp/.

¹⁵ ASTM, 1999, Standard Test Method for Determining Sediment Concentration in Water Samples: American Society of Testing and Materials, D 3977-97, Vol. 11.02, pp. 389-394

¹⁶ The current SAFIT STEs (28 November 2006) list requirements for both the Level I and Level II taxonomic effort, and are located at: http://www.swrcb.ca.gov/swamp/docs/safit/ste_list.pdf. When new editions are published by SAFIT, they will supersede all previous editions. All editions will be posted at the State Water Board’s SWAMP website.

- (2) Sampling locations, and sample collection and handling procedures. This shall include detailed procedures for sample collection, storage, preservation, and shipping to the testing lab to assure that consistent quality control and quality assurance is maintained. Dischargers shall attach to the monitoring program a copy of the Chain of Custody form used when handling and shipping samples.
 - (3) Identification of the analytical methods and related method detection limits (if applicable) for each parameter required in Section M.4.f above.
- ii LUP Type 2 & 3 dischargers shall ensure that all sampling and sample preservation be in accordance with the current edition of "Standard Methods for the Examination of Water and Wastewater" (American Public Health Association). All monitoring instruments and equipment (including a discharger's own field instruments for measuring pH and turbidity) shall be calibrated and maintained in accordance with manufacturers' specifications to ensure accurate measurements. All laboratory analyses shall be conducted according to test procedures under 40 CFR Part 136, unless other test procedures have been specified in this General Permit or by the Regional Water Board. With the exception of field analysis conducted by the discharger for turbidity and pH, all analyses shall be sent to and conducted at a laboratory certified for such analyses by the State Department of Health Services (SSC exception). The LUP discharger shall conduct its own field analysis of pH and may conduct its own field analysis of turbidity if the discharger has sufficient capability (qualified and trained employees, properly calibrated and maintained field instruments, etc.) to adequately perform the field analysis.
- j. LUP Type 2 & 3 Analytical Methods

LUP Type 2 & 3 dischargers shall refer to Table 5 above for test Methods, detection Limits, and reporting Units.

- i **pH:** LUP Type 2 & 3 dischargers shall perform pH analysis on-site with a calibrated pH meter or pH test kit. The LUP discharger shall record pH monitoring results on paper and retain these records in accordance with Section M.4.o, below.
- ii **Turbidity:** LUP Type 2 & 3 dischargers shall perform turbidity analysis using a calibrated turbidity meter (turbidimeter), either on-site or at an accredited lab. Acceptable test methods include Standard Method 2130 or USEPA Method 180.1. The results shall

be recorded in the site log book in Nephelometric Turbidity Units (NTU).

- iii **Suspended sediment concentration (SSC):** LUP Type 3 dischargers exceeding the turbidity Receiving Water Monitoring Trigger, shall perform SSC analysis using ASTM Method D3977-97.
- iv **Bioassessment:** LUP Type 3 dischargers shall perform bioassessment sampling and analysis according to Appendix 3 of this General Permit.

k. Watershed Monitoring Option

If an LUP Type 2 or 3 discharger is part of a qualified regional watershed-based monitoring program the LUP Type 2 or 3 discharger may be eligible for relief from the monitoring requirements in this Attachment. The Regional Water Board may approve proposals to substitute an acceptable watershed-based monitoring program if it determines that the watershed-based monitoring program will provide information to determine each discharger's compliance with the requirements of this General Permit.

l. Particle Size Analysis for Risk Justification

LUP Type 2 & 3 dischargers justifying an alternative project risk shall report a soil particle size analysis used to determine the RUSLE K-Factor. ASTM D-422 (Standard Test Method for Particle-Size Analysis of Soils), as revised, shall be used to determine the percentages of sand, very fine sand, silt, and clay on the site.

m. NAL Exceedance Report

- i In the event that any effluent sample exceeds an applicable NAL, the Regional Water Boards may require LUP Type 2 & 3 dischargers to submit NAL Exceedance Reports.
- ii LUP Type 2 & 3 dischargers shall certify each NAL Exceedance Report in accordance with the Special Provisions for Construction Activity.
- iii LUP Type 2 & 3 dischargers shall retain an electronic or paper copy of each NAL Exceedance Report for a minimum of three years after the date the exceedance report is filed.
- iv LUP Type 2 & 3 dischargers shall include in the NAL Exceedance Report:

- (1) the analytical method(s), method reporting unit(s), and method detection limit(s) of each analytical parameter (analytical results that are less than the method detection limit shall be reported as “less than the method detection limit”); and
- (2) the date, place, time of sampling, visual observation (inspections), and/or measurements, including precipitation.
- (3) Description of the current BMPs associated with the effluent sample that exceeded the NAL and the proposed corrective actions taken.

n. Monitoring Records

LUP Type 2 & 3 dischargers shall ensure that records of all storm water monitoring information and copies of all reports (including Annual Reports) required by this General Permit be retained for a period of at least three years. LUP Type 2 & 3 dischargers may retain records off-site and make them available upon request. These records shall include:

- i The date, place, time of facility inspections, sampling, visual observation (inspections), and/or measurements, including precipitation (rain gauge);
- ii The individual(s) who performed the facility inspections, sampling, visual observation (inspections), and or measurements;
- iii The date and approximate time of analyses;
- iv The individual(s) who performed the analyses;
- v A summary of all analytical results from the last three years, the method detection limits and reporting units, the analytical techniques or methods used, and all chain of custody forms;
- vi Quality assurance/quality control records and results;
- vii Non-storm water discharge inspections and visual observation (inspections) and storm water discharge visual observation records (see Section M.4.a above);
- viii Visual observation and sample collection exception records (see Section M.4.g above); and

- ix The records of any corrective actions and follow-up activities that resulted from analytical results, visual observation (inspections), or inspections.

ATTACHMENT A.1 LUP Project Area or Project Section Area Type Determination

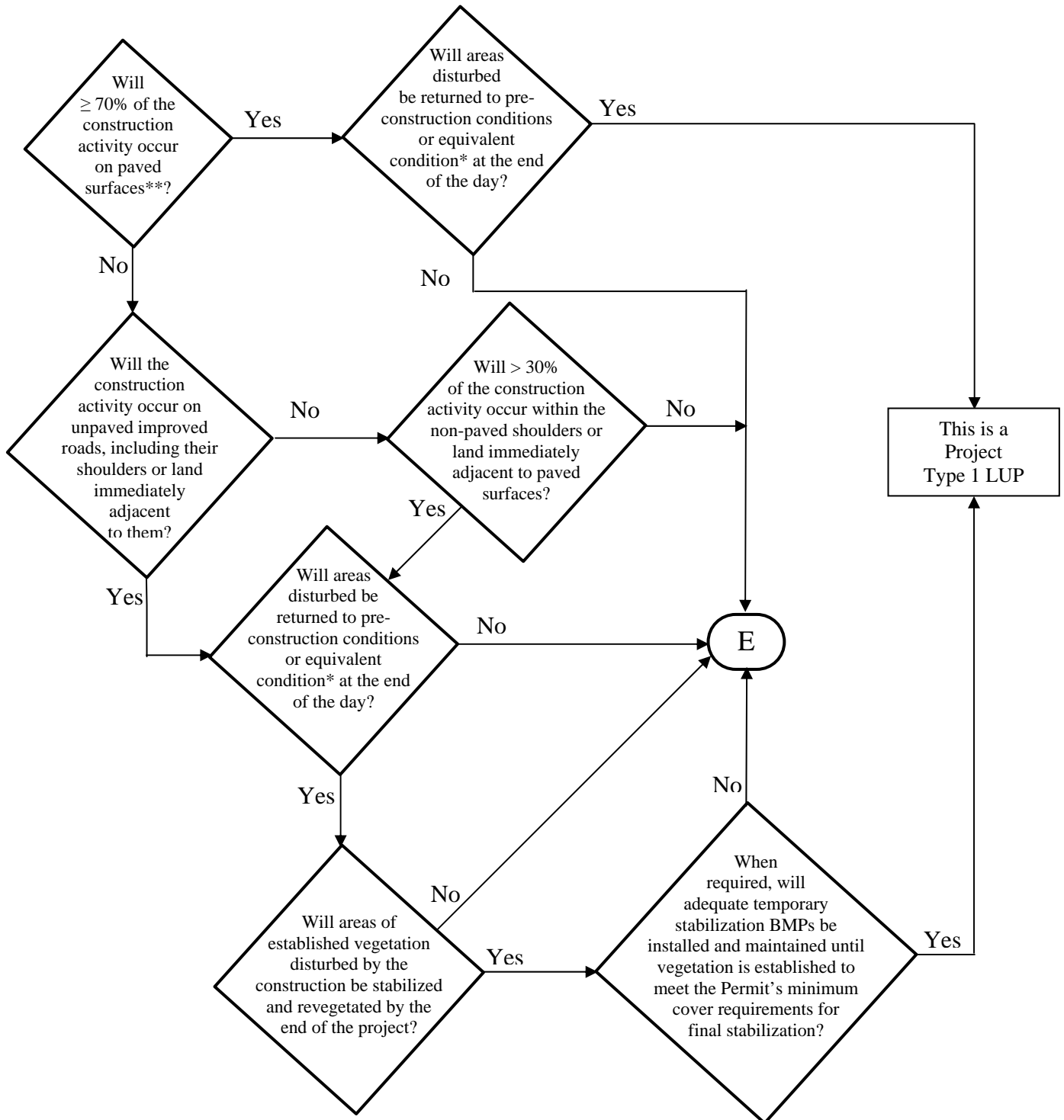

*See Definition of Terms

** Or: "Will < 30% of the soil disturbance occur on unpaved surfaces?"

ATTACHMENT A.1 LUP Project Area or Project Section Area Type Determination

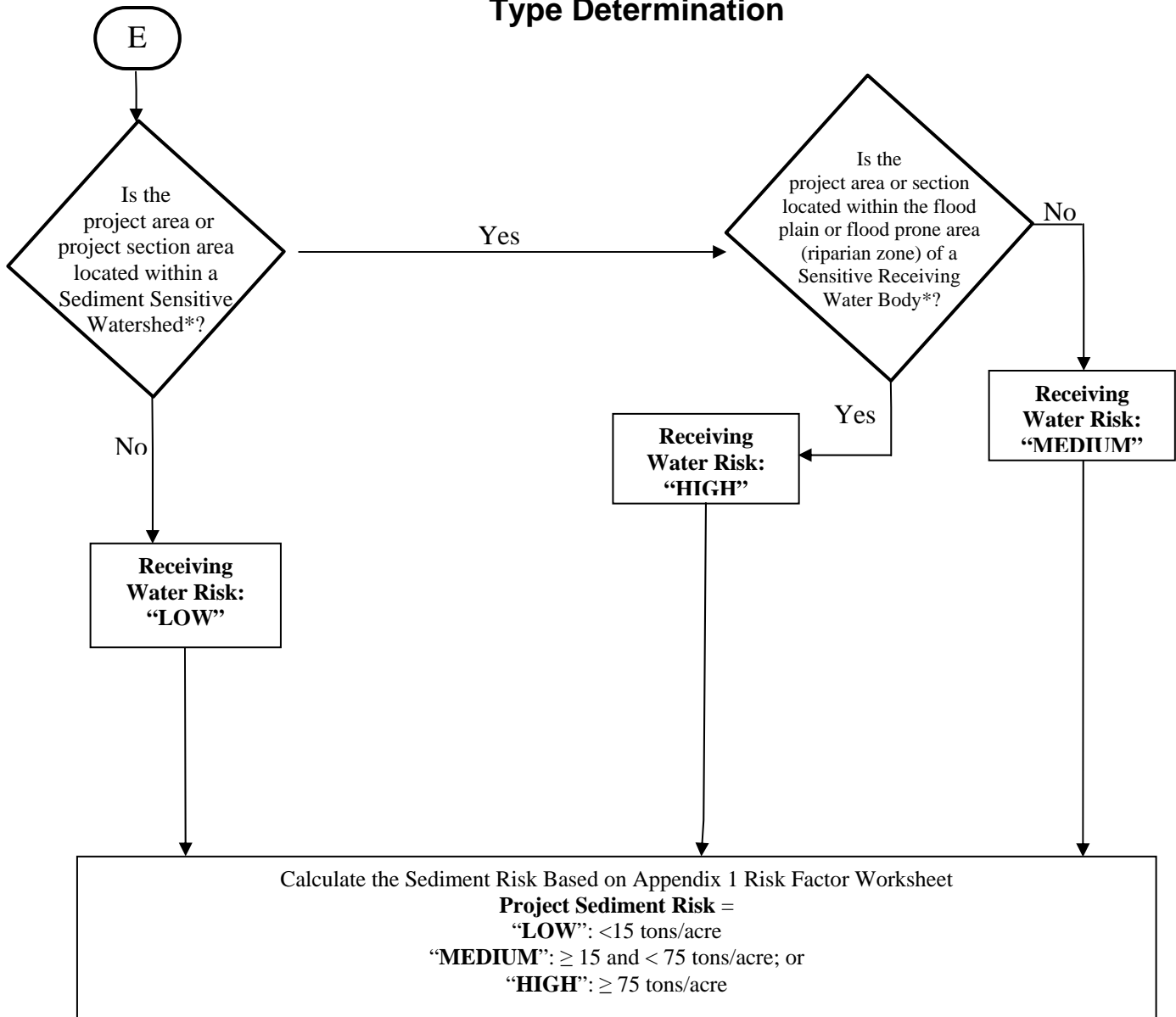

* See Definition of Terms

PROJECT SEDIMENT RISK

RECEIVING WATER RISK

	LOW	MEDIUM	HIGH
LOW	Type 1	Type 1	Type 2
MEDIUM	Type 1	Type 2	Type 3
HIGH	Type 2	Type 3	Type 3

ATTACHMENT A.1

Definition of Terms

1. **Equivalent Condition** – Means disturbed soils such as those from trench excavation are required to be hauled away, backfilled into the trench, and/or covered (e.g., metal plates, pavement, plastic covers over spoil piles) at the end of the construction day.
2. **Linear Construction Activity** – Linear construction activity consists of underground/ overhead facilities that typically include, but are not limited to, any conveyance, pipe or pipeline for the transportation of any gaseous, liquid (including water, wastewater for domestic municipal services), liquescent, or slurry substance; any cable line or wire for the transmission of electrical energy; any cable line or wire for communications (e.g., telephone, telegraph, radio or television messages); and associated ancillary facilities. Construction activities associated with LUPs include, but are not limited to those activities necessary for the installation of underground and overhead linear facilities (e.g., conduits, substructures, pipelines, towers, poles, cables, wires, connectors, switching, regulating and transforming equipment and associated ancillary facilities) and include, but are not limited to, underground utility mark-out, potholing, concrete and asphalt cutting and removal, trenching, excavation, boring and drilling, access road and pole/ tower pad and cable/ wire pull station, substation construction, substructure installation, construction of tower footings and/or foundations, pole and tower installations, pipeline installations, welding, concrete and/or pavement repair or replacement, and stockpile/ borrow locations.
3. **Sediment Sensitive Receiving Water Body** – Defined as a water body segment that is listed on EPA's approved CWA 303(d) list for sedimentation/siltation, turbidity, or is designated with beneficial uses of SPAWN, MIGRATORY, and COLD.
4. **Sediment Sensitive Watershed** – Defined as a watershed draining into a receiving water body listed on EPA's approved CWA 303(d) list for sedimentation/siltation, turbidity, or a water body designated with beneficial uses of SPAWN, MIGRATORY, and COLD.

**ATTACHMENT A.2
PERMIT REGISTRATION DOCUMENTS (PRDs)
GENERAL INSTRUCTIONS FOR LINEAR UNDERGROUND/OVERHEAD PROJECTS TO
COMPLY WITH THE CONSTRUCTION GENERAL PERMIT**

GENERAL INSTRUCTIONS

Who Must Submit

This permit is effective on July 1, 2010.

The Legally Responsible Person (LRP) for construction activities associated with linear underground/overhead project (LUP) must electronically apply for coverage under this General Permit on or after July 1, 2010. If it is determined that the LUP construction activities require an NPDES permit, the Legally Responsible Person¹ (LRP) shall submit PRDs for this General Permit in accordance with the following:

LUPs associated with Private or Municipal Development Projects

1. For LUPs associated with pre-development and pre-redevelopment construction activities:

The LRP must obtain coverage² under this General Permit for its pre-development and pre-redevelopment construction activities where the total disturbed land area of these construction activities is greater than 1 acre.

2. For LUPs associated with new development and redevelopment construction projects:

The LRP must obtain coverage under this General Permit for LUP construction activities associated with new development and redevelopment projects where the total disturbed land area of the LUP is greater than 1 acre. Coverage under this permit is not required where the same LUP construction activities are covered by another NPDES permit.

LUPs not associated with private or municipal new development or redevelopment projects:

The LRP must obtain coverage under this General Permit on or after July 1, 2010 for its LUP construction activities where the total disturbed land area is greater than 1 acre.

PRD Submittal Requirements

Prior to the start of construction activities a LRP must submit PRDs and fees to the State Water Board for each LUP.

New and Ongoing LUPs

Dischargers of new LUPs that commence construction activities after the adoption date of this General Permit shall file PRDs prior to the commencement of construction and implement the SWPPP upon the start of construction.

¹ person possessing the title of the land on which the construction activities will occur for the regulated site

² obtain coverage means filing PRDs for the project.

PERMIT REGISTRATION DOCUMENTS (PRDs) GENERAL INSTRUCTIONS (CONTINUED)

Dischargers of ongoing LUPs that are currently covered under State Water Board Order No. 2003-0007 (Small LUP General Permit) shall electronically file Permit Registration Documents no later than July 1, 2010. After July 1, 2010, all NOIs subject to State Water Board Order No. 2003-0007-DWQ will be terminated. All existing dischargers shall be exempt from the risk determination requirements in Attachment A. All existing dischargers are therefore subject to LUP Type 1 requirements regardless of their project's sediment and receiving water risks. However, a Regional Board retains the authority to require an existing discharger to comply with the risk determination requirements in Attachment A.

Where to Apply

The Permit Registration Documents (PRDs) can be found at www.waterboards.ca.gov/water_issues/programs/stormwater/

Fees

The annual fee for storm water permits are established through the State of California Code of Regulations.

When Permit Coverage Commences

To obtain coverage under the General Permit, the LRP must include the complete PRDs and the annual fee. All PRDs deemed incomplete will be rejected with an explanation as to what is required to complete submittal. Upon receipt of complete PRDs and associated fee, each discharger will be sent a waste discharger's identification (WDID) number.

Projects and Activities Not Defined As Construction Activity

1. LUP construction activity does not include routine maintenance projects to maintain original line and grade, hydraulic capacity, or original purpose of the facility. Routine maintenance projects are projects associated with operations and maintenance activities that are conducted on existing lines and facilities and within existing right-of-way, easements, franchise agreements or other legally binding agreements of the discharger. Routine maintenance projects include, but are not limited to projects that are conducted to:
 - Maintain the original purpose of the facility, or hydraulic capacity.
 - Update existing lines³ and facilities to comply with applicable codes, standards and regulations regardless if such projects result in increased capacity.
 - Repairing leaks.

Routine maintenance does not include construction of new⁴ lines or facilities resulting from compliance with applicable codes, standards and regulations.

³ Update existing lines includes replacing existing lines with new materials or pipes.

⁴ New lines are those that are not associated with existing facilities and are not part of a project to update or replace existing lines.

**PERMIT REGISTRATION DOCUMENTS (PRDs)
GENERAL INSTRUCTIONS (CONTINUED)**

Routine maintenance projects do not include those areas of maintenance projects that are outside of an existing right-of-way, franchise, easements, or agreements. When a project must acquire new areas, those areas may be subject to this General Permit based on the area of disturbed land outside the original right-of-way, easement, or agreement.

2. LUP construction activity does not include field activities associated with the planning and design of a project (e.g., activities associated with route selection).
3. Tie-ins conducted immediately adjacent to “energized” or “pressurized” facilities by the discharger are not considered small construction activities where all other LUP construction activities associated with the tie-in are covered by a NOI and SWPPP of a third party or municipal agency.

Calculating Land Disturbance Areas of LUPs

The total land area disturbed for LUPs is the sum of the:

- Surface areas of trenches, laterals and ancillary facilities, plus
- Area of the base of stockpiles on unpaved surfaces, plus
- Surface area of the borrow area, plus
- Areas of paved surfaces constructed for the project, plus
- Areas of new roads constructed or areas of major reconstruction to existing roads (e.g. improvements to two-track surfaces or road widening) for the sole purpose of accessing construction activities or as part of the final project, plus
- Equipment and material storage, staging, and preparation areas (laydown areas) not on paved surfaces, plus
- Soil areas outside the surface area of trenches, laterals and ancillary facilities that will be graded, and/or disturbed by the use of construction equipment, vehicles and machinery during construction activities.

Stockpiling Areas

Stockpiling areas, borrow areas and the removal of soils from a construction site may or may not be included when calculating the area of disturbed soil for a site depending on the following conditions:

- For stockpiling of soils onsite or immediately adjacent to a LUP site and the stockpile is not on a paved surface, the area of the base of the stockpile is to be included in the disturbed area calculation.
- The surface area of borrow areas that are onsite or immediately adjacent to a project site are to be included in the disturbed area calculation.
- For soil that is hauled offsite to a location owned or operated by the discharger that is not a paved surface, the area of the base of the stockpile is to be included in the disturbed area calculation except when the offsite location is already subject to a separate storm water permit.

**PERMIT REGISTRATION DOCUMENTS (PRDs)
GENERAL INSTRUCTIONS (CONTINUED)**

- For soil that is brought to the project from an off-site location owned or operated by the discharger the surface area of the borrow pit is to be included in the disturbed area calculation except when the offsite location is already subject to a separate storm water permit.
- Trench spoils on a paved surface that are either returned to the trench or excavation or hauled away from the project daily for disposal or reuse will not be included in the disturbed area calculation.

If you have any questions concerning submittal of PRDs, please call the State Water Board at (866) 563-3107.

**ATTACHMENT B
PERMIT REGISTRATION DOCUMENTS (PRDs) TO COMPLY WITH THE TERMS
OF THE GENERAL PERMIT TO DISCHARGE STORM WATER
ASSOCIATED WITH CONSTRUCTION ACTIVITY**

GENERAL INSTRUCTIONS

- A.** All Linear Construction Projects shall comply with the PRD requirements in Attachment A.2 of this Order.

B. Who Must Submit

Discharges of storm water associated with construction that results in the disturbance of one acre or more of land must apply for coverage under the General Construction Storm Water Permit (General Permit). Any construction activity that is a part of a larger common plan of development or sale must also be permitted, regardless of size. (For example, if 0.5 acre of a 20-acre subdivision is disturbed by the construction activities of discharger A and the remaining 19.5 acres is to be developed by discharger B, discharger A must obtain a General Storm Water Permit for the 0.5 acre project).

Other discharges from construction activities that are covered under this General Permit can be found in the General Permit Section II.B.

It is the LRP's responsibility to obtain coverage under this General Permit by electronically submitting complete PRDs (Permit Registration Documents).

In all cases, the proper procedures for submitting the PRDs must be completed before construction can commence.

C. Construction Activity Not Covered By This General Permit

Discharges from construction that are not covered under this General Permit can be found in the General Permit Sections II.A & B..

D. Annual Fees and Fee Calculation

Annual fees are calculated based upon the total area of land to be disturbed not the total size of the acreage owned. However, the calculation includes all acres to be disturbed during the duration of the project. For example, if 10 acres are scheduled to be disturbed the first year and 10 in each subsequent year for 5 years, the annual fees would be based upon 50 acres of disturbance. The State Water Board will evaluate adding acreage to an existing Permit Waste Discharge Identification (WDID) number on a case-by-case basis. In general, any acreage to be considered must be contiguous to the permitted land area and the existing

SWPPP must be appropriate for the construction activity and topography of the acreage under consideration. As acreage is built out and stabilized or sold, the Change of Information (COI) form enables the applicant to remove those acres from inclusion in the annual fee calculation. Checks should be made payable to: State Water Board.

The Annual fees are established through regulations adopted by the State Water Board. The total annual fee is the current base fee plus applicable surcharges for all construction sites submitting an NOI, based on the total acreage to be disturbed during the life of the project. Annual fees are subject to change by regulation.

Dischargers that apply for and satisfy the Small Construction Erosivity Waiver requirements shall pay a fee of \$200.00 plus an applicable surcharge, see the General Permit Section II.B.7.

E. When to Apply

LRP's proposing to conduct construction activities subject to this General Permit must submit their PRDs prior to the commencement of construction activity.

F. Requirements for Completing Permit Registration Documents (PRDs)

All dischargers required to comply with this General Permit shall electronically submit the required PRDs for their type of construction as defined below.

G. Standard PRD Requirements (All Dischargers)

1. Notice of Intent
2. Risk Assessment (Standard or Site-Specific)
3. Site Map
4. SWPPP
5. Annual Fee
6. Certification

H. Additional PRD Requirements Related to Construction Type

1. Discharger in unincorporated areas of the State (not covered under an adopted Phase I or II SUSMP requirements) and that are not a linear project shall also submit a completed:
 - a. Post-Construction Water Balance Calculator (Appendix 2).
2. Dischargers who are proposing to implement ATS shall submit:
 - a. Complete ATS Plan in accordance with Attachment F at least 14 days prior to the planned operation of the ATS and a paper copy shall be available onsite during ATS operation.

- b. Certification proof that design done by a professional in accordance with Attachment F.
- 3. Dischargers who are proposing an alternate Risk Justification:
 - a. Particle Size Analysis.

I. Exceptions to Standard PRD Requirements

Construction sites with an R value less than 5 as determined in the Risk Assessment are not required to submit a SWPPP.

J. Description of PRDs

1. Notice of Intent (NOI)
2. Site Map(s) Includes:
 - a. The project's surrounding area (vicinity)
 - b. Site layout
 - c. Construction site boundaries
 - d. Drainage areas
 - e. Discharge locations
 - f. Sampling locations
 - g. Areas of soil disturbance (temporary or permanent)
 - h. Active areas of soil disturbance (cut or fill)
 - i. Locations of all runoff BMPs
 - j. Locations of all erosion control BMPs
 - k. Locations of all sediment control BMPs
 - l. ATS location (if applicable)
 - m. Locations of sensitive habitats, watercourses, or other features which are not to be disturbed
 - n. Locations of all post-construction BMPs
 - o. Locations of storage areas for waste, vehicles, service, loading/unloading of materials, access (entrance/exits) points to construction site, fueling, and water storage, water transfer for dust control and compaction practices
3. **SWPPPs**
A site-specific SWPPP shall be developed by each discharger and shall be submitted with the PRDs.
4. **Risk Assessment**
All dischargers shall use the Risk Assessment procedure as describe in the General Permit Appendix 1.
 - a. The Standard Risk Assessment includes utilization of the following:
 - i. Receiving water Risk Assessment interactive map

- ii. EPA Rainfall Erosivity Factor Calculator Website
 - iii. Sediment Risk interactive map
 - iv. Sediment sensitive water bodies list
- b. The Site-Specific Risk Assessment includes the completion of the hand calculated R value Risk Calculator
5. **Post-Construction Water Balance Calculator**
All dischargers subject to this requirement shall complete the Water Balance Calculator (in Appendix 2) in accordance with the instructions.
6. **ATS Design Document and Certification**
All dischargers using ATS must submit electronically their system design (as well as any supporting documentation) and proof that the system was designed by a qualified ATS design professional (See Attachment F).

To obtain coverage under the General Permit PRDs must be included and completed. If any of the required items are missing, the PRD submittal is considered incomplete and will be rejected. Upon receipt of a complete PRD submittal, the State Water Board will process the application package in the order received and assign a (WDID) number.

Questions?

If you have any questions on completing the PRDs please email stormwater@waterboards.ca.gov or call (866) 563-3107.

ATTACHMENT C RISK LEVEL 1 REQUIREMENTS

A. Effluent Standards

[These requirements are the same as those in the General Permit order.]

1. Narrative – Risk Level 1 dischargers shall comply with the narrative effluent standards listed below:
 - a. Storm water discharges and authorized non-storm water discharges regulated by this General Permit shall not contain a hazardous substance equal to or in excess of reportable quantities established in 40 C.F.R. §§ 117.3 and 302.4, unless a separate NPDES Permit has been issued to regulate those discharges.
 - b. Dischargers shall minimize or prevent pollutants in storm water discharges and authorized non-storm water discharges through the use of controls, structures, and management practices that achieve BAT for toxic and non-conventional pollutants and BCT for conventional pollutants.
2. Numeric – Risk Level 1 dischargers are not subject to a numeric effluent standard.

B. Good Site Management "Housekeeping"

1. Risk Level 1 dischargers shall implement good site management (i.e., "housekeeping") measures for construction materials that could potentially be a threat to water quality if discharged. At a minimum, Risk Level 1 dischargers shall implement the following good housekeeping measures:
 - a. Conduct an inventory of the products used and/or expected to be used and the end products that are produced and/or expected to be produced. This does not include materials and equipment that are designed to be outdoors and exposed to environmental conditions (i.e. poles, equipment pads, cabinets, conductors, insulators, bricks, etc.).
 - b. Cover and berm loose stockpiled construction materials that are not actively being used (i.e. soil, spoils, aggregate, fly-ash, stucco, hydrated lime, etc.).

- c. Store chemicals in watertight containers (with appropriate secondary containment to prevent any spillage or leakage) or in a storage shed (completely enclosed).
 - d. Minimize exposure of construction materials to precipitation. This does not include materials and equipment that are designed to be outdoors and exposed to environmental conditions (i.e. poles, equipment pads, cabinets, conductors, insulators, bricks, etc.).
 - e. Implement BMPs to prevent the off-site tracking of loose construction and landscape materials.
2. Risk Level 1 dischargers shall implement good housekeeping measures for waste management, which, at a minimum, shall consist of the following:
- a. Prevent disposal of any rinse or wash waters or materials on impervious or pervious site surfaces or into the storm drain system.
 - b. Ensure the containment of sanitation facilities (e.g., portable toilets) to prevent discharges of pollutants to the storm water drainage system or receiving water.
 - c. Clean or replace sanitation facilities and inspecting them regularly for leaks and spills.
 - d. Cover waste disposal containers at the end of every business day and during a rain event.
 - e. Prevent discharges from waste disposal containers to the storm water drainage system or receiving water.
 - f. Contain and securely protect stockpiled waste material from wind and rain at all times unless actively being used.
 - g. Implement procedures that effectively address hazardous and non-hazardous spills.
 - h. Develop a spill response and implementation element of the SWPPP prior to commencement of construction activities. The SWPPP shall require that:
 - i. Equipment and materials for cleanup of spills shall be available on site and that spills and leaks shall be cleaned up immediately and disposed of properly; and

- ii. Appropriate spill response personnel are assigned and trained.
 - i. Ensure the containment of concrete washout areas and other washout areas that may contain additional pollutants so there is no discharge into the underlying soil and onto the surrounding areas.
3. Risk Level 1 dischargers shall implement good housekeeping for vehicle storage and maintenance, which, at a minimum, shall consist of the following:
 - a. Prevent oil, grease, or fuel to leak in to the ground, storm drains or surface waters.
 - b. Place all equipment or vehicles, which are to be fueled, maintained and stored in a designated area fitted with appropriate BMPs.
 - c. Clean leaks immediately and disposing of leaked materials properly.
4. Risk Level 1 dischargers shall implement good housekeeping for landscape materials, which, at a minimum, shall consist of the following:
 - a. Contain stockpiled materials such as mulches and topsoil when they are not actively being used.
 - b. Contain fertilizers and other landscape materials when they are not actively being used.
 - c. Discontinue the application of any erodible landscape material within 2 days before a forecasted rain event or during periods of precipitation.
 - d. Apply erodible landscape material at quantities and application rates according to manufacture recommendations or based on written specifications by knowledgeable and experienced field personnel.
 - e. Stack erodible landscape material on pallets and covering or storing such materials when not being used or applied.
5. Risk Level 1 dischargers shall conduct an assessment and create a list of potential pollutant sources and identify any areas of the site where additional BMPs are necessary to reduce or prevent pollutants in storm water discharges and authorized non-storm water discharges. This potential pollutant list shall be kept with the SWPPP and shall identify

all non-visible pollutants which are known, or should be known, to occur on the construction site. At a minimum, when developing BMPs, Risk Level 1 dischargers shall do the following:

- a. Consider the quantity, physical characteristics (e.g., liquid, powder, solid), and locations of each potential pollutant source handled, produced, stored, recycled, or disposed of at the site.
 - b. Consider the degree to which pollutants associated with those materials may be exposed to and mobilized by contact with storm water.
 - c. Consider the direct and indirect pathways that pollutants may be exposed to storm water or authorized non-storm water discharges. This shall include an assessment of past spills or leaks, non-storm water discharges, and discharges from adjoining areas.
 - d. Ensure retention of sampling, visual observation, and inspection records.
 - e. Ensure effectiveness of existing BMPs to reduce or prevent pollutants in storm water discharges and authorized non-storm water discharges.
6. Risk Level 1 dischargers shall implement good housekeeping measures on the construction site to control the air deposition of site materials and from site operations. Such particulates can include, but are not limited to, sediment, nutrients, trash, metals, bacteria, oil and grease and organics.

C. Non-Storm Water Management

1. Risk Level 1 dischargers shall implement measures to control all non-storm water discharges during construction.
2. Risk Level 1 dischargers shall wash vehicles in such a manner as to prevent non-storm water discharges to surface waters or MS4 drainage systems.
3. Risk Level 1 dischargers shall clean streets in such a manner as to prevent unauthorized non-storm water discharges from reaching surface water or MS4 drainage systems.

D. Erosion Control

1. Risk Level 1 dischargers shall implement effective wind erosion control.
2. Risk Level 1 dischargers shall provide effective soil cover for inactive¹ areas and all finished slopes, open space, utility backfill, and completed lots.
3. Risk Level 1 dischargers shall limit the use of plastic materials when more sustainable, environmentally friendly alternatives exist. Where plastic materials are deemed necessary, the discharger shall consider the use of plastic materials resistant to solar degradation.

E. Sediment Controls

1. Risk Level 1 dischargers shall establish and maintain effective perimeter controls and stabilize all construction entrances and exits to sufficiently control erosion and sediment discharges from the site.
2. On sites where sediment basins are to be used, Risk Level 1 dischargers shall, at minimum, design sediment basins according to the method provided in CASQA's Construction BMP Guidance Handbook.

F. Run-on and Runoff Controls

Risk Level 1 dischargers shall effectively manage all run-on, all runoff within the site and all runoff that discharges off the site. Run-on from off site shall be directed away from all disturbed areas or shall collectively be in compliance with the effluent limitations in this General Permit.

G. Inspection, Maintenance and Repair

1. Risk Level 1 dischargers shall ensure that all inspection, maintenance repair and sampling activities at the project location shall be performed or supervised by a Qualified SWPPP Practitioner (QSP) representing the discharger. The QSP may delegate any or all of these activities to an employee trained to do the task(s) appropriately, but shall ensure adequate deployment.
2. Risk Level 1 dischargers shall perform weekly inspections and observations, and at least once each 24-hour period during extended

¹ Inactive areas of construction are areas of construction activity that have been disturbed and are not scheduled to be re-disturbed for at least 14 days.

storm events, to identify and record BMPs that need maintenance to operate effectively, that have failed, or that could fail to operate as intended. Inspectors shall be the QSP or be trained by the QSP.

3. Upon identifying failures or other shortcomings, as directed by the QSP, Risk Level 1 dischargers shall begin implementing repairs or design changes to BMPs within 72 hours of identification and complete the changes as soon as possible.
4. For each inspection required, Risk Level 1 dischargers shall complete an inspection checklist, using a form provided by the State Water Board or Regional Water Board or in an alternative format.
5. Risk Level 1 dischargers shall ensure that checklists shall remain onsite with the SWPPP and at a minimum, shall include:
 - a. Inspection date and date the inspection report was written.
 - b. Weather information, including presence or absence of precipitation, estimate of beginning of qualifying storm event, duration of event, time elapsed since last storm, and approximate amount of rainfall in inches.
 - c. Site information, including stage of construction, activities completed, and approximate area of the site exposed.
 - d. A description of any BMPs evaluated and any deficiencies noted.
 - e. If the construction site is safely accessible during inclement weather, list the observations of all BMPs: erosion controls, sediment controls, chemical and waste controls, and non-storm water controls. Otherwise, list the results of visual inspections at all relevant outfalls, discharge points, downstream locations and any projected maintenance activities.
 - f. Report the presence of noticeable odors or of any visible sheen on the surface of any discharges.
 - g. Any corrective actions required, including any necessary changes to the SWPPP and the associated implementation dates.
 - h. Photographs taken during the inspection, if any.
 - i. Inspector's name, title, and signature.

H. Rain Event Action Plan

Not required for Risk Level 1 dischargers.

I. Risk Level 1 Monitoring and Reporting Requirements

Table 1- Summary of Monitoring Requirements

Risk Level	Visual Inspections					Sample Collection	
	Quarterly Non-storm Water Discharge	Pre-storm Event		Daily Storm BMP	Post Storm	Storm Water Discharge	Receiving Water
		Baseline	REAP				
1	X	X		X	X		

1. Construction Site Monitoring Program Requirements

- a. Pursuant to Water Code Sections 13383 and 13267, all dischargers subject to this General Permit shall develop and implement a written site-specific Construction Site Monitoring Program (CSMP) in accordance with the requirements of this Section. The CSMP shall include all monitoring procedures and instructions, location maps, forms, and checklists as required in this section. The CSMP shall be developed prior to the commencement of construction activities, and revised as necessary to reflect project revisions. The CSMP shall be a part of the Storm Water Pollution Prevention Plan (SWPPP), included as an appendix or separate SWPPP chapter.
- b. Existing dischargers registered under the State Water Board Order No. 99-08-DWQ shall make and implement necessary revisions to their Monitoring Programs to reflect the changes in this General Permit in a timely manner, but no later than July 1, 2010. Existing dischargers shall continue to implement their existing Monitoring Programs in compliance with State Water Board Order No. 99-08-DWQ until the necessary revisions are completed according to the schedule above.
- c. When a change of ownership occurs for all or any portion of the construction site prior to completion or final stabilization, the new discharger shall comply with these requirements as of the date the ownership change occurs.

2. Objectives

The CSMP shall be developed and implemented to address the following objectives:

- a. To demonstrate that the site is in compliance with the Discharge Prohibitions;

- b. To determine whether non-visible pollutants are present at the construction site and are causing or contributing to exceedances of water quality objectives;
 - c. To determine whether immediate corrective actions, additional Best Management Practice (BMP) implementation, or SWPPP revisions are necessary to reduce pollutants in storm water discharges and authorized non-storm water discharges; and
 - d. To determine whether BMPs included in the SWPPP are effective in preventing or reducing pollutants in storm water discharges and authorized non-storm water discharges.
- 3. Risk Level 1 - Visual Monitoring (Inspection) Requirements for Qualifying Rain Events**
- a. Risk Level 1 dischargers shall visually observe (inspect) storm water discharges at all discharge locations within two business days (48 hours) after each qualifying rain event.
 - b. Risk Level 1 dischargers shall visually observe (inspect) the discharge of stored or contained storm water that is derived from and discharged subsequent to a qualifying rain event producing precipitation of ½ inch or more at the time of discharge. Stored or contained storm water that will likely discharge after operating hours due to anticipated precipitation shall be observed prior to the discharge during operating hours.
 - c. Risk Level 1 dischargers shall conduct visual observations (inspections) during business hours only.
 - d. Risk Level 1 dischargers shall record the time, date and rain gauge reading of all qualifying rain events.
 - e. Within 2 business days (48 hours) prior to each qualifying rain event, Risk Level 1 dischargers shall visually observe (inspect):
 - i. All storm water drainage areas to identify any spills, leaks, or uncontrolled pollutant sources. If needed, the discharger shall implement appropriate corrective actions.
 - ii. All BMPs to identify whether they have been properly implemented in accordance with the SWPPP. If needed, the discharger shall implement appropriate corrective actions.

- iii. Any storm water storage and containment areas to detect leaks and ensure maintenance of adequate freeboard.
- f. For the visual observations (inspections) described in e.i and e.iii above, Risk Level 1 dischargers shall observe the presence or absence of floating and suspended materials, a sheen on the surface, discolorations, turbidity, odors, and source(s) of any observed pollutants.
- g. Within two business days (48 hours) after each qualifying rain event, Risk Level 1 dischargers shall conduct post rain event visual observations (inspections) to (1) identify whether BMPs were adequately designed, implemented, and effective, and (2) identify additional BMPs and revise the SWPPP accordingly.
- h. Risk Level 1 dischargers shall maintain on-site records of all visual observations (inspections), personnel performing the observations, observation dates, weather conditions, locations observed, and corrective actions taken in response to the observations.

4. Risk Level 1 – Visual Observation Exemptions

- a. Risk Level 1 dischargers shall be prepared to conduct visual observation (inspections) until the minimum requirements of Section I.3 above are completed. Risk Level 1 dischargers are not required to conduct visual observation (inspections) under the following conditions:
 - i. During dangerous weather conditions such as flooding and electrical storms.
 - ii. Outside of scheduled site business hours.
- b. If no required visual observations (inspections) are collected due to these exceptions, Risk Level 1 dischargers shall include an explanation in their SWPPP and in the Annual Report documenting why the visual observations (inspections) were not conducted.

5. Risk Level 1 – Monitoring Methods

Risk Level 1 dischargers shall include a description of the visual observation locations, visual observation procedures, and visual observation follow-up and tracking procedures in the CSMP.

6. Risk Level 1 – Non-Storm Water Discharge Monitoring Requirements

- a. Visual Monitoring Requirements:
 - i. Risk Level 1 dischargers shall visually observe (inspect) each drainage area for the presence of (or indications of prior) unauthorized and authorized non-storm water discharges and their sources.
 - ii. Risk Level 1 dischargers shall conduct one visual observation (inspection) quarterly in each of the following periods: January-March, April-June, July-September, and October-December. Visual observation (inspections) are only required during daylight hours (sunrise to sunset).
 - iii. Risk Level 1 dischargers shall ensure that visual observations (inspections) document the presence or evidence of any non-storm water discharge (authorized or unauthorized), pollutant characteristics (floating and suspended material, sheen, discoloration, turbidity, odor, etc.), and source. Risk Level 1 dischargers shall maintain on-site records indicating the personnel performing the visual observation (inspections), the dates and approximate time each drainage area and non-storm water discharge was observed, and the response taken to eliminate unauthorized non-storm water discharges and to reduce or prevent pollutants from contacting non-storm water discharges.

7. Risk Level 1 – Non-Visible Pollutant Monitoring Requirements

- a. Risk Level 1 dischargers shall collect one or more samples during any breach, malfunction, leakage, or spill observed during a visual inspection which could result in the discharge of pollutants to surface waters that would not be visually detectable in storm water.
- b. Risk Level 1 dischargers shall ensure that water samples are large enough to characterize the site conditions.
- c. Risk Level 1 dischargers shall collect samples at all discharge locations that can be safely accessed.
- d. Risk Level 1 dischargers shall collect samples during the first two hours of discharge from rain events that occur during business hours and which generate runoff.
- e. Risk Level 1 dischargers shall analyze samples for all non-visible pollutant parameters (if applicable) - parameters indicating the

presence of pollutants identified in the pollutant source assessment required (Risk Level 1 dischargers shall modify their CSMPs to address these additional parameters in accordance with any updated SWPPP pollutant source assessment).

- f. Risk Level 1 dischargers shall collect a sample of storm water that has not come in contact with the disturbed soil or the materials stored or used on-site (uncontaminated sample) for comparison with the discharge sample.
- g. Risk Level 1 dischargers shall compare the uncontaminated sample to the samples of discharge using field analysis or through laboratory analysis.²
- h. Risk Level 1 dischargers shall keep all field /or analytical data in the SWPPP document.

8. Risk Level 1 – Particle Size Analysis for Project Risk Justification

Risk Level 1 dischargers justifying an alternative project risk shall report a soil particle size analysis used to determine the RUSLE K-Factor. ASTM D-422 (Standard Test Method for Particle-Size Analysis of Soils), as revised, shall be used to determine the percentages of sand, very fine sand, silt, and clay on the site.

9. Risk Level 1 – Records

Risk Level 1 dischargers shall retain records of all storm water monitoring information and copies of all reports (including Annual Reports) for a period of at least three years. Risk Level 1 dischargers shall retain all records on-site while construction is ongoing. These records include:

- a. The date, place, time of facility inspections, sampling, visual observation (inspections), and/or measurements, including precipitation.
- b. The individual(s) who performed the facility inspections, sampling, visual observation (inspections), and or measurements.
- c. The date and approximate time of analyses.
- d. The individual(s) who performed the analyses.

² For laboratory analysis, all sampling, sample preservation, and analyses must be conducted according to test procedures under 40 CFR Part 136. Field discharge samples shall be collected and analyzed according to the specifications of the manufacturer of the sampling devices employed.

- e. A summary of all analytical results from the last three years, the method detection limits and reporting units, and the analytical techniques or methods used.
- f. Rain gauge readings from site inspections.
- g. Quality assurance/quality control records and results.
- h. Non-storm water discharge inspections and visual observation (inspections) and storm water discharge visual observation records (see Sections I.3 and I.6 above).
- i. Visual observation and sample collection exception records (see Section I.4 above).
- j. The records of any corrective actions and follow-up activities that resulted from analytical results, visual observation (inspections), or inspections.

ATTACHMENT D RISK LEVEL 2 REQUIREMENTS

A. Effluent Standards

[These requirements are the same as those in the General Permit order.]

1. Narrative – Risk Level 2 dischargers shall comply with the narrative effluent standards listed below:
 - a. Storm water discharges and authorized non-storm water discharges regulated by this General Permit shall not contain a hazardous substance equal to or in excess of reportable quantities established in 40 C.F.R. §§ 117.3 and 302.4, unless a separate NPDES Permit has been issued to regulate those discharges.
 - b. Dischargers shall minimize or prevent pollutants in storm water discharges and authorized non-storm water discharges through the use of controls, structures, and management practices that achieve BAT for toxic and non-conventional pollutants and BCT for conventional pollutants.
2. Numeric – Risk level 2 dischargers are subject to a pH NAL of 6.5-8.5, and a turbidity NAL of 250 NTU.

B. Good Site Management "Housekeeping"

1. Risk Level 2 dischargers shall implement good site management (i.e., "housekeeping") measures for construction materials that could potentially be a threat to water quality if discharged. At a minimum, Risk Level 2 dischargers shall implement the following good housekeeping measures:
 - a. Conduct an inventory of the products used and/or expected to be used and the end products that are produced and/or expected to be produced. This does not include materials and equipment that are designed to be outdoors and exposed to environmental conditions (i.e. poles, equipment pads, cabinets, conductors, insulators, bricks, etc.).
 - b. Cover and berm loose stockpiled construction materials that are not actively being used (i.e. soil, spoils, aggregate, fly-ash, stucco, hydrated lime, etc.).

- c. Store chemicals in watertight containers (with appropriate secondary containment to prevent any spillage or leakage) or in a storage shed (completely enclosed).
 - d. Minimize exposure of construction materials to precipitation. This does not include materials and equipment that are designed to be outdoors and exposed to environmental conditions (i.e. poles, equipment pads, cabinets, conductors, insulators, bricks, etc.).
 - e. Implement BMPs to prevent the off-site tracking of loose construction and landscape materials.
2. Risk Level 2 dischargers shall implement good housekeeping measures for waste management, which, at a minimum, shall consist of the following:
- a. Prevent disposal of any rinse or wash waters or materials on impervious or pervious site surfaces or into the storm drain system.
 - b. Ensure the containment of sanitation facilities (e.g., portable toilets) to prevent discharges of pollutants to the storm water drainage system or receiving water.
 - c. Clean or replace sanitation facilities and inspecting them regularly for leaks and spills.
 - d. Cover waste disposal containers at the end of every business day and during a rain event.
 - e. Prevent discharges from waste disposal containers to the storm water drainage system or receiving water.
 - f. Contain and securely protect stockpiled waste material from wind and rain at all times unless actively being used.
 - g. Implement procedures that effectively address hazardous and non-hazardous spills.
 - h. Develop a spill response and implementation element of the SWPPP prior to commencement of construction activities. The SWPPP shall require:
 - i. Equipment and materials for cleanup of spills shall be available on site and that spills and leaks shall be cleaned up immediately and disposed of properly.

- ii. Appropriate spill response personnel are assigned and trained.
 - i. Ensure the containment of concrete washout areas and other washout areas that may contain additional pollutants so there is no discharge into the underlying soil and onto the surrounding areas.
- 3. Risk Level 2 dischargers shall implement good housekeeping for vehicle storage and maintenance, which, at a minimum, shall consist of the following:
 - a. Prevent oil, grease, or fuel to leak in to the ground, storm drains or surface waters.
 - b. Place all equipment or vehicles, which are to be fueled, maintained and stored in a designated area fitted with appropriate BMPs.
 - c. Clean leaks immediately and disposing of leaked materials properly.
- 4. Risk Level 2 dischargers shall implement good housekeeping for landscape materials, which, at a minimum, shall consist of the following:
 - a. Contain stockpiled materials such as mulches and topsoil when they are not actively being used.
 - b. Contain all fertilizers and other landscape materials when they are not actively being used.
 - c. Discontinue the application of any erodible landscape material within 2 days before a forecasted rain event or during periods of precipitation.
 - d. Apply erodible landscape material at quantities and application rates according to manufacture recommendations or based on written specifications by knowledgeable and experienced field personnel.
 - e. Stack erodible landscape material on pallets and covering or storing such materials when not being used or applied.
- 5. Risk Level 2 dischargers shall conduct an assessment and create a list of potential pollutant sources and identify any areas of the site where additional BMPs are necessary to reduce or prevent pollutants in storm water discharges and authorized non-storm water discharges. This potential pollutant list shall be kept with the SWPPP and shall identify

all non-visible pollutants which are known, or should be known, to occur on the construction site. At a minimum, when developing BMPs, Risk Level 2 dischargers shall do the following:

- a. Consider the quantity, physical characteristics (e.g., liquid, powder, solid), and locations of each potential pollutant source handled, produced, stored, recycled, or disposed of at the site.
 - b. Consider the degree to which pollutants associated with those materials may be exposed to and mobilized by contact with storm water.
 - c. Consider the direct and indirect pathways that pollutants may be exposed to storm water or authorized non-storm water discharges. This shall include an assessment of past spills or leaks, non-storm water discharges, and discharges from adjoining areas.
 - d. Ensure retention of sampling, visual observation, and inspection records.
 - e. Ensure effectiveness of existing BMPs to reduce or prevent pollutants in storm water discharges and authorized non-storm water discharges.
6. Risk Level 2 dischargers shall implement good housekeeping measures on the construction site to control the air deposition of site materials and from site operations. Such particulates can include, but are not limited to, sediment, nutrients, trash, metals, bacteria, oil and grease and organics.
7. **Additional Risk Level 2 Requirement:** Risk Level 2 dischargers shall document all housekeeping BMPs in the SWPPP and REAP(s) in accordance with the nature and phase of the construction project. Construction phases at traditional land development projects include Grading and Land Development Phase, Streets and Utilities, or Vertical Construction for traditional land development projects.

C. Non-Storm Water Management

1. Risk Level 2 dischargers shall implement measures to control all non-storm water discharges during construction.
2. Risk Level 2 dischargers shall wash vehicles in such a manner as to prevent non-storm water discharges to surface waters or MS4 drainage systems.

3. Risk Level 2 dischargers shall clean streets in such a manner as to prevent unauthorized non-storm water discharges from reaching surface water or MS4 drainage systems.

D. Erosion Control

1. Risk Level 2 dischargers shall implement effective wind erosion control.
2. Risk Level 2 dischargers shall provide effective soil cover for inactive¹ areas and all finished slopes, open space, utility backfill, and completed lots.
3. Risk Level 2 dischargers shall limit the use of plastic materials when more sustainable, environmentally friendly alternatives exist. Where plastic materials are deemed necessary, the discharger shall consider the use of plastic materials resistant to solar degradation.

E. Sediment Controls

1. Risk Level 2 dischargers shall establish and maintain effective perimeter controls and stabilize all construction entrances and exits to sufficiently control erosion and sediment discharges from the site.
2. On sites where sediment basins are to be used, Risk Level 2 dischargers shall, at minimum, design sediment basins according to the method provided in CASQA's Construction BMP Guidance Handbook.
3. **Additional Risk Level 2 Requirement:** Risk Level 2 dischargers shall implement appropriate erosion control BMPs (runoff control and soil stabilization) in conjunction with sediment control BMPs for areas under active² construction.
4. **Additional Risk Level 2 Requirement:** Risk Level 2 dischargers shall apply linear sediment controls along the toe of the slope, face of the slope, and at the grade breaks of exposed slopes to comply with sheet flow lengths³ in accordance with Table 1.

¹ Inactive areas of construction are areas of construction activity that have been disturbed and are not scheduled to be re-disturbed for at least 14 days.

² Active areas of construction are areas undergoing land surface disturbance. This includes construction activity during the preliminary stage, mass grading stage, streets and utilities stage and the vertical construction stage.

³ Sheet flow length is the length that shallow, low velocity flow travels across a site.

Table 1 - Critical Slope/Sheet Flow Length Combinations

Slope Percentage	Sheet flow length not to exceed
0-25%	20 feet
25-50%	15 feet
Over 50%	10 feet

5. **Additional Risk Level 2 Requirement:** Risk Level 2 dischargers shall ensure that construction activity traffic to and from the project is limited to entrances and exits that employ effective controls to prevent offsite tracking of sediment.
6. **Additional Risk Level 2 Requirement:** Risk Level 2 dischargers shall ensure that all storm drain inlets and perimeter controls, runoff control BMPs, and pollutant controls at entrances and exits (e.g. tire washoff locations) are maintained and protected from activities that reduce their effectiveness.
7. **Additional Risk Level 2 Requirement:** Risk Level 2 dischargers shall inspect on a daily basis all immediate access roads daily. At a minimum daily (when necessary) and prior to any rain event, the discharger shall remove any sediment or other construction activity-related materials that are deposited on the roads (by vacuuming or sweeping).

F. Run-on and Run-off Controls

Risk Level 2 dischargers shall effectively manage all run-on, all runoff within the site and all runoff that discharges off the site. Run-on from off site shall be directed away from all disturbed areas or shall collectively be in compliance with the effluent limitations in this General Permit.

G. Inspection, Maintenance and Repair

1. Risk Level 2 dischargers shall ensure that all inspection, maintenance repair and sampling activities at the project location shall be performed or supervised by a Qualified SWPPP Practitioner (QSP) representing the discharger. The QSP may delegate any or all of these activities to an employee appropriately trained to do the task(s).
2. Risk Level 2 dischargers shall perform weekly inspections and observations, and at least once each 24-hour period during extended storm events, to identify and record BMPs that need maintenance to operate effectively, that have failed, or that could fail to operate as intended. Inspectors shall be the QSP or be trained by the QSP.

3. Upon identifying failures or other shortcomings, as directed by the QSP, Risk Level 2 dischargers shall begin implementing repairs or design changes to BMPs within 72 hours of identification and complete the changes as soon as possible.
4. For each inspection required, Risk Level 2 dischargers shall complete an inspection checklist, using a form provided by the State Water Board or Regional Water Board or in an alternative format.
5. Risk Level 2 dischargers shall ensure that checklists shall remain onsite with the SWPPP and at a minimum, shall include:
 - a. Inspection date and date the inspection report was written.
 - b. Weather information, including presence or absence of precipitation, estimate of beginning of qualifying storm event, duration of event, time elapsed since last storm, and approximate amount of rainfall in inches.
 - c. Site information, including stage of construction, activities completed, and approximate area of the site exposed.
 - d. A description of any BMPs evaluated and any deficiencies noted.
 - e. If the construction site is safely accessible during inclement weather, list the observations of all BMPs: erosion controls, sediment controls, chemical and waste controls, and non-storm water controls. Otherwise, list the results of visual inspections at all relevant outfalls, discharge points, downstream locations and any projected maintenance activities.
 - f. Report the presence of noticeable odors or of any visible sheen on the surface of any discharges.
 - g. Any corrective actions required, including any necessary changes to the SWPPP and the associated implementation dates.
 - h. Photographs taken during the inspection, if any.
 - i. Inspector's name, title, and signature.

H. Rain Event Action Plan

1. **Additional Risk Level 2 Requirement:** The discharger shall ensure a QSP develop a Rain Event Action Plan (REAP) 48 hours prior to any

likely precipitation event. A likely precipitation event is any weather pattern that is forecast to have a 50% or greater probability of producing precipitation in the project area. The discharger shall ensure a QSP obtain a printed copy of precipitation forecast information from the National Weather Service Forecast Office (e.g., by entering the zip code of the project's location at <http://www.srh.noaa.gov/forecast>).

2. **Additional Risk Level 2 Requirement:** The discharger shall ensure a QSP develop the REAPs for all phases of construction (i.e., Grading and Land Development, Streets and Utilities, Vertical Construction, Final Landscaping and Site Stabilization).
3. **Additional Risk Level 2 Requirement:** The discharger shall ensure a QSP ensure that the REAP include, at a minimum, the following site information:
 - a. Site Address
 - b. Calculated Risk Level (2 or 3)
 - c. Site Storm Water Manager Information including the name, company, and 24-hour emergency telephone number
 - d. Erosion and Sediment Control Provider information including the name, company, and 24-hour emergency telephone number
 - e. Storm Water Sampling Agent information including the name, company, and 24-hour emergency telephone number
4. **Additional Risk Level 2 Requirement:** The discharger shall ensure a QSP include in the REAP, at a minimum, the following project phase information:
 - a. Activities associated with each construction phase
 - b. Trades active on the construction site during each construction phase
 - c. Trade contractor information
 - d. Suggested actions for each project phase
5. **Additional Risk Level 2 Requirement:** The discharger shall ensure a QSP develop additional REAPs for project sites where construction activities are indefinitely halted or postponed (Inactive Construction). At a minimum, Inactive Construction REAPs must include:
 - a. Site Address
 - b. Calculated Risk Level (2 or 3)
 - c. Site Storm Water Manager Information including the name, company, and 24-hour emergency telephone number

- d. Erosion and Sediment Control Provider information including the name, company, and 24-hour emergency telephone number
 - e. Storm Water Sampling Agent information including the name, company, and 24-hour emergency telephone number
 - f. Trades active on site during Inactive Construction
 - g. Trade contractor information
 - h. Suggested actions for inactive construction sites
6. **Additional Risk Level 2 Requirement:** The discharger shall ensure a QSP begin implementation and make the REAP available onsite no later than 24 hours prior to the likely precipitation event.
7. **Additional Risk Level 2 Requirement:** The discharger shall ensure a QSP maintain onsite a paper copy of each REAP onsite in compliance with the record retention requirements of the Special Provisions in this General Permit.

I. Risk Level 2 Monitoring and Reporting Requirements

Table 2- Summary of Monitoring Requirements

Risk Level	Visual Inspections					Sample Collection	
	Quarterly Non-storm Water Discharge	Pre-storm Event		Daily Storm BMP	Post Storm	Storm Water Discharge	Receiving Water
		Baseline	REAP				
2	X	X	X	X	X	X	

1. Construction Site Monitoring Program Requirements

- a. Pursuant to Water Code Sections 13383 and 13267, all dischargers subject to this General Permit shall develop and implement a written site-specific Construction Site Monitoring Program (CSMP) in accordance with the requirements of this Section. The CSMP shall include all monitoring procedures and instructions, location maps, forms, and checklists as required in this section. The CSMP shall be developed prior to the commencement of construction activities, and revised as necessary to reflect project revisions. The CSMP shall be a part of the Storm Water Pollution Prevention Plan (SWPPP), included as an appendix or separate SWPPP chapter.
- b. Existing dischargers registered under the State Water Board Order No. 99-08-DWQ shall make and implement necessary revisions to their Monitoring Program to reflect the changes in this General Permit in a timely manner, but no later than July 1, 2010. Existing dischargers shall continue to implement their existing Monitoring Programs in compliance with State Water Board Order No. 99-08-DWQ until the necessary revisions are completed according to the schedule above.
- c. When a change of ownership occurs for all or any portion of the construction site prior to completion or final stabilization, the new discharger shall comply with these requirements as of the date the ownership change occurs.

2. Objectives

The CSMP shall be developed and implemented to address the following objectives:

- a. To demonstrate that the site is in compliance with the Discharge Prohibitions and applicable Numeric Action Levels (NALs).

- b. To determine whether non-visible pollutants are present at the construction site and are causing or contributing to exceedances of water quality objectives.
 - c. To determine whether immediate corrective actions, additional Best Management Practice (BMP) implementation, or SWPPP revisions are necessary to reduce pollutants in storm water discharges and authorized non-storm water discharges.
 - d. To determine whether BMPs included in the SWPPP/Rain Event Action Plan (REAP) are effective in preventing or reducing pollutants in storm water discharges and authorized non-storm water discharges.
- 3. Risk Level 2 – Visual Monitoring (Inspection) Requirements for Qualifying Rain Events**
- a. Risk Level 2 dischargers shall visually observe (inspect) storm water discharges at all discharge locations within two business days (48 hours) after each qualifying rain event.
 - b. Risk Level 2 dischargers shall visually observe (inspect) the discharge of stored or contained storm water that is derived from and discharged subsequent to a qualifying rain event producing precipitation of ½ inch or more at the time of discharge. Stored or contained storm water that will likely discharge after operating hours due to anticipated precipitation shall be observed prior to the discharge during operating hours.
 - c. Risk Level 2 dischargers shall conduct visual observations (inspections) during business hours only.
 - d. Risk Level 2 dischargers shall record the time, date and rain gauge reading of all qualifying rain events.
 - e. Within 2 business days (48 hours) prior to each qualifying rain event, Risk Level 2 dischargers shall visually observe (inspect):
 - i. all storm water drainage areas to identify any spills, leaks, or uncontrolled pollutant sources. If needed, the discharger shall implement appropriate corrective actions.
 - ii. all BMPs to identify whether they have been properly implemented in accordance with the SWPPP/REAP. If needed, the discharger shall implement appropriate corrective actions.

- iii. any storm water storage and containment areas to detect leaks and ensure maintenance of adequate freeboard.
- f. For the visual observations (inspections) described in c.i and c.iii above, Risk Level 2 dischargers shall observe the presence or absence of floating and suspended materials, a sheen on the surface, discolorations, turbidity, odors, and source(s) of any observed pollutants.
- g. Within two business days (48 hours) after each qualifying rain event, Risk Level 2 dischargers shall conduct post rain event visual observations (inspections) to (1) identify whether BMPs were adequately designed, implemented, and effective, and (2) identify additional BMPs and revise the SWPPP accordingly.
- h. Risk Level 2 dischargers shall maintain on-site records of all visual observations (inspections), personnel performing the observations, observation dates, weather conditions, locations observed, and corrective actions taken in response to the observations.

4. Risk Level 2 – Water Quality Sampling and Analysis

- a. Risk Level 2 dischargers shall collect storm water grab samples from sampling locations, as defined in Section I.5. The storm water grab sample(s) obtained shall be representative of the flow and characteristics of the discharge.
- b. At minimum, Risk Level 2 dischargers shall collect 3 samples per day of the qualifying event.
- c. Risk Level 2 dischargers shall ensure that the grab samples collected of stored or contained storm water are from discharges subsequent to a qualifying rain event (producing precipitation of ½ inch or more at the time of discharge).

Storm Water Effluent Monitoring Requirements

- d. Risk Level 2 dischargers shall analyze their effluent samples for:
 - i. pH and turbidity.
 - ii. Any additional parameters for which monitoring is required by the Regional Water Board.

5. Risk Level 2 – Storm Water Discharge Water Quality Sampling Locations

Effluent Sampling Locations

- a. Risk Level 2 dischargers shall perform sampling and analysis of storm water discharges to characterize discharges associated with construction activity from the entire project disturbed area.
- b. Risk Level 2 dischargers shall collect effluent samples at all discharge points where storm water is discharged off-site.
- c. Risk Level 2 dischargers shall ensure that storm water discharge collected and observed represent⁴ the effluent in each drainage area based on visual observation of the water and upstream conditions.
- d. Risk Level 2 dischargers shall monitor and report site run-on from surrounding areas if there is reason to believe run-on may contribute to an exceedance of NALs.
- e. Risk Level 2 dischargers who deploy an ATS on their site, or a portion on their site, shall collect ATS effluent samples and measurements from the discharge pipe or another location representative of the nature of the discharge.
- f. Risk Level 2 dischargers shall select analytical test methods from the list provided in Table 3 below.
- g. All storm water sample collection preservation and handling shall be conducted in accordance with Section I.7 “Storm Water Sample Collection and Handling Instructions” below.

6. Risk Level 2 – Visual Observation and Sample Collection Exemptions

- a. Risk Level 2 dischargers shall be prepared to collect samples and conduct visual observation (inspections) until the minimum requirements of Sections I.3 and I.4 above are completed. Risk Level 2 dischargers are not required to physically collect samples or conduct visual observation (inspections) under the following conditions:

⁴ For example, if there has been concrete work recently in an area, or drywall scrap is exposed to the rain, a pH sample shall be taken of drainage from the relevant work area. Similarly, if sediment laden water is flowing through some parts of a silt fence, samples shall be taken of the sediment-laden water even if most water flowing through the fence is clear.

- i. During dangerous weather conditions such as flooding and electrical storms.
 - ii. Outside of scheduled site business hours.
- b. If no required samples or visual observation (inspections) are collected due to these exceptions, Risk Level 2 dischargers shall include an explanation in their SWPPP and in the Annual Report documenting why the sampling or visual observation (inspections) were not conducted.
- 7. Risk Level 2 – Storm Water Sample Collection and Handling Instructions**

- a. Risk Level 2 dischargers shall refer to Table 3 below for test methods, detection limits, and reporting units.
- b. Risk Level 2 dischargers shall ensure that testing laboratories will receive samples within 48 hours of the physical sampling (unless otherwise required by the laboratory), and shall use only the sample containers provided by the laboratory to collect and store samples.
- c. Risk Level 2 dischargers shall designate and train personnel to collect, maintain, and ship samples in accordance with the Surface Water Ambient Monitoring Program's (SWAMP) 2008 Quality Assurance Program Plan (QAPrP).⁵

8. Risk Level 2 – Monitoring Methods

- a. Risk Level 2 dischargers shall include a description of the following items in the CSMP:
 - i. Visual observation locations, visual observation procedures, and visual observation follow-up and tracking procedures.
 - ii. Sampling locations, and sample collection and handling procedures. This shall include detailed procedures for sample collection, storage, preservation, and shipping to the testing lab to assure that consistent quality control and quality assurance is maintained. Dischargers shall attach to the monitoring program

⁵ Additional information regarding SWAMP's QAPrP can be found at http://www.waterboards.ca.gov/water_issues/programs/swamp/.
QAPrP:http://www.waterboards.ca.gov/water_issues/programs/swamp/docs/qapp/swamp_qapp_master090108a.pdf.

an example Chain of Custody form used when handling and shipping samples.

- iii. Identification of the analytical methods and related method detection limits (if applicable) for each parameter required in Section I.4 above.
- b. Risk Level 2 dischargers shall ensure that all sampling and sample preservation are in accordance with the current edition of "Standard Methods for the Examination of Water and Wastewater" (American Public Health Association). All monitoring instruments and equipment (including a discharger's own field instruments for measuring pH and turbidity) should be calibrated and maintained in accordance with manufacturers' specifications to ensure accurate measurements. Risk Level 2 dischargers shall ensure that all laboratory analyses are conducted according to test procedures under 40 CFR Part 136, unless other test procedures have been specified in this General Permit or by the Regional Water Board. With the exception of field analysis conducted by the discharger for turbidity and pH, all analyses should be sent to and conducted at a laboratory certified for such analyses by the State Department of Health Services. Risk Level 2 dischargers shall conduct their own field analysis of pH and may conduct their own field analysis of turbidity if the discharger has sufficient capability (qualified and trained employees, properly calibrated and maintained field instruments, etc.) to adequately perform the field analysis.

9. Risk Level 2 – Analytical Methods

- a. Risk Level 2 dischargers shall refer to Table 3 below for test methods, detection limits, and reporting units.
- b. **pH:** Risk Level 2 dischargers shall perform pH analysis on-site with a calibrated pH meter or a pH test kit. Risk Level 2 dischargers shall record pH monitoring results on paper and retain these records in accordance with Section I.14, below.
- c. **Turbidity:** Risk Level 2 dischargers shall perform turbidity analysis using a calibrated turbidity meter (turbidimeter), either on-site or at an accredited lab. Acceptable test methods include Standard Method 2130 or USEPA Method 180.1. The results will be recorded in the site log book in Nephelometric Turbidity Units (NTU).

10. Risk Level 2 - Non-Storm Water Discharge Monitoring Requirements

- a. Visual Monitoring Requirements:
 - i. Risk Level 2 dischargers shall visually observe (inspect) each drainage area for the presence of (or indications of prior) unauthorized and authorized non-storm water discharges and their sources.
 - ii. Risk Level 2 dischargers shall conduct one visual observation (inspection) quarterly in each of the following periods: January-March, April-June, July-September, and October-December. Visual observation (inspections) are only required during daylight hours (sunrise to sunset).
 - iii. Risk Level 2 dischargers shall ensure that visual observations (inspections) document the presence or evidence of any non-storm water discharge (authorized or unauthorized), pollutant characteristics (floating and suspended material, sheen, discoloration, turbidity, odor, etc.), and source. Risk Level 2 dischargers shall maintain on-site records indicating the personnel performing the visual observation (inspections), the dates and approximate time each drainage area and non-storm water discharge was observed, and the response taken to eliminate unauthorized non-storm water discharges and to reduce or prevent pollutants from contacting non-storm water discharges.
- b. Effluent Sampling Locations:
 - i. Risk Level 2 dischargers shall sample effluent at all discharge points where non-storm water and/or authorized non-storm water is discharged off-site.
 - ii. Risk Level 2 dischargers shall send all non-storm water sample analyses to a laboratory certified for such analyses by the State Department of Health Services.
 - iii. Risk Level 2 dischargers shall monitor and report run-on from surrounding areas if there is reason to believe run-on may contribute to an exceedance of NALs.

11. Risk Level 2 – Non-Visible Pollutant Monitoring Requirements

- a. Risk Level 2 dischargers shall collect one or more samples during any breach, malfunction, leakage, or spill observed during a visual

inspection which could result in the discharge of pollutants to surface waters that would not be visually detectable in storm water.

- b. Risk Level 2 dischargers shall ensure that water samples are large enough to characterize the site conditions.
- c. Risk Level 2 dischargers shall collect samples at all discharge locations that can be safely accessed.
- d. Risk Level 2 dischargers shall collect samples during the first two hours of discharge from rain events that occur during business hours and which generate runoff.
- e. Risk Level 2 dischargers shall analyze samples for all non-visible pollutant parameters (if applicable) - parameters indicating the presence of pollutants identified in the pollutant source assessment required (Risk Level 2 dischargers shall modify their CSMPs to address these additional parameters in accordance with any updated SWPPP pollutant source assessment).
- f. Risk Level 2 dischargers shall collect a sample of storm water that has not come in contact with the disturbed soil or the materials stored or used on-site (uncontaminated sample) for comparison with the discharge sample.
- g. Risk Level 2 dischargers shall compare the uncontaminated sample to the samples of discharge using field analysis or through laboratory analysis.⁶
- h. Risk Level 2 dischargers shall keep all field /or analytical data in the SWPPP document.

12. Risk Level 2 – Watershed Monitoring Option

Risk Level 2 dischargers who are part of a qualified regional watershed-based monitoring program may be eligible for relief from the requirements in Sections I.5. The Regional Water Board may approve proposals to substitute an acceptable watershed-based monitoring program by determining if the watershed-based monitoring program will provide substantially similar monitoring information in evaluating discharger compliance with the requirements of this General Permit.

⁶ For laboratory analysis, all sampling, sample preservation, and analyses must be conducted according to test procedures under 40 CFR Part 136. Field discharge samples shall be collected and analyzed according to the specifications of the manufacturer of the sampling devices employed.

13. Risk Level 2 – Particle Size Analysis for Project Risk Justification

Risk Level 2 dischargers justifying an alternative project risk shall report a soil particle size analysis used to determine the RUSLE K-Factor. ASTM D-422 (Standard Test Method for Particle-Size Analysis of Soils), as revised, shall be used to determine the percentages of sand, very fine sand, silt, and clay on the site.

14. Risk Level 2 – Records

Risk Level 2 dischargers shall retain records of all storm water monitoring information and copies of all reports (including Annual Reports) for a period of at least three years. Risk Level 2 dischargers shall retain all records on-site while construction is ongoing. These records include:

- a. The date, place, time of facility inspections, sampling, visual observation (inspections), and/or measurements, including precipitation.
- b. The individual(s) who performed the facility inspections, sampling, visual observation (inspections), and or measurements.
- c. The date and approximate time of analyses.
- d. The individual(s) who performed the analyses.
- e. A summary of all analytical results from the last three years, the method detection limits and reporting units, the analytical techniques or methods used, and the chain of custody forms.
- f. Rain gauge readings from site inspections;
- g. Quality assurance/quality control records and results.
- h. Non-storm water discharge inspections and visual observation (inspections) and storm water discharge visual observation records (see Sections I.3 and I.10 above).
- i. Visual observation and sample collection exception records (see Section I.6 above).
- j. The records of any corrective actions and follow-up activities that resulted from analytical results, visual observation (inspections), or inspections.

15. Risk Level 2 – NAL Exceedance Report

- a. In the event that any effluent sample exceeds an applicable NAL, Risk Level 2 dischargers shall electronically submit all storm event sampling results to the State Water Board no later than 10 days after the conclusion of the storm event. The Regional Boards have the authority to require the submittal of an NAL Exceedance Report.
- b. Risk Level 2 dischargers shall certify each NAL Exceedance Report in accordance with the Special Provisions for Construction Activity.
- c. Risk Level 2 dischargers shall retain an electronic or paper copy of each NAL Exceedance Report for a minimum of three years after the date the annual report is filed.
- d. Risk Level 2 dischargers shall include in the NAL Exceedance Report:
 - i. The analytical method(s), method reporting unit(s), and method detection limit(s) of each analytical parameter (analytical results that are less than the method detection limit shall be reported as “less than the method detection limit”).
 - ii. The date, place, time of sampling, visual observation (inspections), and/or measurements, including precipitation.
 - iii. A description of the current BMPs associated with the effluent sample that exceeded the NAL and the proposed corrective actions taken.

Table 3 – Risk Level 2 Test Methods, Detection Limits, Reporting Units and Applicable NALs/NELs

Parameter	Test Method / Protocol	Discharge Type	Min. Detection Limit	Reporting Units	Numeric Action Level
pH	Field test with calibrated portable instrument	Risk Level 2 Discharges	0.2	pH units	lower NAL = 6.5 upper NAL = 8.5
Turbidity	EPA 0180.1 and/or field test with calibrated portable instrument	Risk Level 2 Discharges other than ATS	1	NTU	250 NTU
		For ATS discharges	1	NTU	N/A

ATTACHMENT E RISK LEVEL 3 REQUIREMENTS

A. Effluent Standards

[These requirements are the same as those in the General Permit order.]

1. Narrative – Risk Level 3 dischargers shall comply with the narrative effluent standards listed below:
 - a. Storm water discharges and authorized non-storm water discharges regulated by this General Permit shall not contain a hazardous substance equal to or in excess of reportable quantities established in 40 C.F.R. §§ 117.3 and 302.4, unless a separate NPDES Permit has been issued to regulate those discharges.
 - b. Dischargers shall minimize or prevent pollutants in storm water discharges and authorized non-storm water discharges through the use of controls, structures, and management practices that achieve BAT for toxic and non-conventional pollutants and BCT for conventional pollutants.
2. Numeric – Risk Level 3 dischargers are subject to a pH NAL of 6.5-8.5, and a turbidity NAL of 250 NTU.

B. Good Site Management "Housekeeping"

1. Risk Level 3 dischargers shall implement good site management (i.e., "housekeeping") measures for construction materials that could potentially be a threat to water quality if discharged. At a minimum, Risk Level 3 dischargers shall implement the following good housekeeping measures:
 - a. Conduct an inventory of the products used and/or expected to be used and the end products that are produced and/or expected to be produced. This does not include materials and equipment that are designed to be outdoors and exposed to environmental conditions (i.e. poles, equipment pads, cabinets, conductors, insulators, bricks, etc.).
 - b. Cover and berm loose stockpiled construction materials that are not actively being used (i.e. soil, spoils, aggregate, fly-ash, stucco, hydrated lime, etc.).

- c. Store chemicals in watertight containers (with appropriate secondary containment to prevent any spillage or leakage) or in a storage shed (completely enclosed).
 - d. Minimize exposure of construction materials to precipitation. This does not include materials and equipment that are designed to be outdoors and exposed to environmental conditions (i.e. poles, equipment pads, cabinets, conductors, insulators, bricks, etc.).
 - e. Implement BMPs to prevent the off-site tracking of loose construction and landscape materials.
2. Risk Level 3 dischargers shall implement good housekeeping measures for waste management, which, at a minimum, shall consist of the following:
- a. Prevent disposal of any rinse or wash waters or materials on impervious or pervious site surfaces or into the storm drain system.
 - b. Ensure the containment of sanitation facilities (e.g., portable toilets) to prevent discharges of pollutants to the storm water drainage system or receiving water.
 - c. Clean or replace sanitation facilities and inspecting them regularly for leaks and spills.
 - d. Cover waste disposal containers at the end of every business day and during a rain event.
 - e. Prevent discharges from waste disposal containers to the storm water drainage system or receiving water.
 - f. Contain and securely protecting stockpiled waste material from wind and rain at all times unless actively being used.
 - g. Implement procedures that effectively address hazardous and non-hazardous spills.
 - h. Develop a spill response and implementation element of the SWPPP prior to commencement of construction activities. The SWPPP shall require that:
 - i. Equipment and materials for cleanup of spills shall be available on site and that spills and leaks shall be cleaned up immediately and disposed of properly; and

- ii. Appropriate spill response personnel are assigned and trained.
 - i. Ensure the containment of concrete washout areas and other washout areas that may contain additional pollutants so there is no discharge into the underlying soil and onto the surrounding areas.
3. Risk Level 3 dischargers shall implement good housekeeping for vehicle storage and maintenance, which, at a minimum, shall consist of the following:
 - a. Prevent oil, grease, or fuel to leak in to the ground, storm drains or surface waters.
 - b. Place all equipment or vehicles, which are to be fueled, maintained and stored in a designated area fitted with appropriate BMPs.
 - c. Clean leaks immediately and disposing of leaked materials properly.
4. Risk Level 3 dischargers shall implement good housekeeping for landscape materials, which, at a minimum, shall consist of the following:
 - a. Contain stockpiled materials such as mulches and topsoil when they are not actively being used.
 - b. Contain fertilizers and other landscape materials when they are not actively being used.
 - c. Discontinuing the application of any erodible landscape material within 2 days before a forecasted rain event or during periods of precipitation.
 - d. Applying erodible landscape material at quantities and application rates according to manufacture recommendations or based on written specifications by knowledgeable and experienced field personnel.
 - e. Stacking erodible landscape material on pallets and covering or storing such materials when not being used or applied.
5. Risk Level 3 dischargers shall conduct an assessment and create a list of potential pollutant sources and identify any areas of the site where additional BMPs are necessary to reduce or prevent pollutants in storm water discharges and authorized non-storm water discharges. This potential pollutant list shall be kept with the SWPPP and shall identify

all non-visible pollutants which are known, or should be known, to occur on the construction site. At a minimum, when developing BMPs, Risk Level 3 dischargers shall do the following:

- a. Consider the quantity, physical characteristics (e.g., liquid, powder, solid), and locations of each potential pollutant source handled, produced, stored, recycled, or disposed of at the site.
 - b. Consider the degree to which pollutants associated with those materials may be exposed to and mobilized by contact with storm water.
 - c. Consider the direct and indirect pathways that pollutants may be exposed to storm water or authorized non-storm water discharges. This shall include an assessment of past spills or leaks, non-storm water discharges, and discharges from adjoining areas.
 - d. Ensure retention of sampling, visual observation, and inspection records.
 - e. Ensure effectiveness of existing BMPs to reduce or prevent pollutants in storm water discharges and authorized non-storm water discharges.
6. Risk Level 3 dischargers shall implement good housekeeping measures on the construction site to control the air deposition of site materials and from site operations. Such particulates can include, but are not limited to, sediment, nutrients, trash, metals, bacteria, oil and grease and organics.
7. **Additional Risk Level 3 Requirement:** Risk Level 3 dischargers shall document all housekeeping BMPs in the SWPPP and REAP(s) in accordance with the nature and phase of the construction project. Construction phases at traditional land development projects include Grading and Land Development Phase, Streets and Utilities, or Vertical Construction for traditional land development projects.

C. Non-Storm Water Management

1. Risk Level 3 dischargers shall implement measures to control all non-storm water discharges during construction.
2. Risk Level 3 dischargers shall wash vehicles in such a manner as to prevent non-storm water discharges to surface waters or MS4 drainage systems.

3. Risk Level 3 dischargers shall clean streets in such a manner as to prevent unauthorized non-storm water discharges from reaching surface water or MS4 drainage systems.

D. Erosion Control

1. Risk Level 3 dischargers shall implement effective wind erosion control.
2. Risk Level 3 dischargers shall provide effective soil cover for inactive¹ areas and all finished slopes, open space, utility backfill, and completed lots.
3. Dischargers shall limit the use of plastic materials when more sustainable, environmentally friendly alternatives exist. Where plastic materials are deemed necessary, the discharger shall consider the use of plastic materials resistant to solar degradation.

E. Sediment Controls

1. Risk Level 3 dischargers shall establish and maintain effective perimeter controls and stabilize all construction entrances and exits to sufficiently control erosion and sediment discharges from the site.
2. On sites where sediment basins are to be used, Risk Level 3 dischargers shall, at minimum, design sediment basins according to the method provided in CASQA's Construction BMP Guidance Handbook.
3. **Additional Risk Level 3 Requirement:** Risk Level 3 dischargers shall implement appropriate erosion control BMPs (runoff control and soil stabilization) in conjunction with sediment control BMPs for areas under active² construction.
4. **Additional Risk Level 3 Requirement:** Risk Level 3 dischargers shall apply linear sediment controls along the toe of the slope, face of the slope, and at the grade breaks of exposed slopes to comply with sheet flow lengths³ in accordance with Table 1.

¹ Inactive areas of construction are areas of construction activity that have been disturbed and are not scheduled to be re-disturbed for at least 14 days.

² Active areas of construction are areas undergoing land surface disturbance. This includes construction activity during the preliminary stage, mass grading stage, streets and utilities stage and the vertical construction stage

³ Sheet flow length is the length that shallow, low velocity flow travels across a site.

Table 1 - Critical Slope/Sheet Flow Length Combinations

Slope Percentage	Sheet flow length not to exceed
0-25%	20 feet
25-50%	15 feet
Over 50%	10 feet

5. **Additional Risk Level 3 Requirement:** Risk Level 3 dischargers shall ensure that construction activity traffic to and from the project is limited to entrances and exits that employ effective controls to prevent offsite tracking of sediment.
6. **Additional Risk Level 3 Requirement:** Risk Level 3 dischargers shall ensure that all storm drain inlets and perimeter controls, runoff control BMPs, and pollutant controls at entrances and exits (e.g. tire washoff locations) are maintained and protected from activities that reduce their effectiveness.
7. **Additional Risk Level 3 Requirement:** Risk Level 3 dischargers shall inspect on a daily basis all immediate access roads daily. At a minimum daily (when necessary) and prior to any rain event, the discharger shall remove any sediment or other construction activity-related materials that are deposited on the roads (by vacuuming or sweeping).
8. **Additional Risk Level 3 Requirement:** The Regional Water Board may require Risk Level 3 dischargers to implement additional site-specific sediment control requirements if the implementation of the other requirements in this section are not adequately protecting the receiving waters.

F. Run-on and Run-off Controls

Risk Level 3 dischargers shall effectively manage all run-on, all runoff within the site and all runoff that discharges off the site. Run-on from off site shall be directed away from all disturbed areas or shall collectively be in compliance with the effluent limitations in this General Permit.

G. Inspection, Maintenance and Repair

1. Risk Level 3 dischargers shall ensure that all inspection, maintenance repair and sampling activities at the project location shall be performed or supervised by a Qualified SWPPP Practitioner (QSP) representing the discharger. The QSP may delegate any or all of these activities to an employee appropriately trained to do the task(s).

2. Risk Level 3 dischargers shall perform weekly inspections and observations, and at least once each 24-hour period during extended storm events, to identify and record BMPs that need maintenance to operate effectively, that have failed, or that could fail to operate as intended. Inspectors shall be the QSP or be trained by the QSP.
3. Upon identifying failures or other shortcomings, as directed by the QSP, Risk Level 3 dischargers shall begin implementing repairs or design changes to BMPs within 72 hours of identification and complete the changes as soon as possible.
4. For each inspection required, Risk Level 3 dischargers shall complete an inspection checklist, using a form provided by the State Water Board or Regional Water Board or in an alternative format.
5. Risk Level 3 dischargers shall ensure that checklists shall remain onsite with the SWPPP and at a minimum, shall include:
 - a. Inspection date and date the inspection report was written.
 - b. Weather information, including presence or absence of precipitation, estimate of beginning of qualifying storm event, duration of event, time elapsed since last storm, and approximate amount of rainfall in inches.
 - c. Site information, including stage of construction, activities completed, and approximate area of the site exposed.
 - d. A description of any BMPs evaluated and any deficiencies noted.
 - e. If the construction site is safely accessible during inclement weather, list the observations of all BMPs: erosion controls, sediment controls, chemical and waste controls, and non-storm water controls. Otherwise, list the results of visual inspections at all relevant outfalls, discharge points, downstream locations and any projected maintenance activities.
 - f. Report the presence of noticeable odors or of any visible sheen on the surface of any discharges.
 - g. Any corrective actions required, including any necessary changes to the SWPPP and the associated implementation dates.
 - h. Photographs taken during the inspection, if any.

- i. Inspector's name, title, and signature.

H. Rain Event Action Plan

1. **Additional Risk Level 3 Requirement:** The discharger shall ensure a QSP develop a Rain Event Action Plan (REAP) 48 hours prior to any likely precipitation event. A likely precipitation event is any weather pattern that is forecast to have a 50% or greater probability of producing precipitation in the project area. The QSP shall obtain a printed copy of precipitation forecast information from the National Weather Service Forecast Office (e.g., by entering the zip code of the project's location at <http://www.srh.noaa.gov/forecast>).
2. **Additional Risk Level 3 Requirement:** The discharger shall ensure a QSP develop the REAPs for all phases of construction (i.e., Grading and Land Development, Streets and Utilities, Vertical Construction, Final Landscaping and Site Stabilization).
3. **Additional Risk Level 3 Requirement:** The discharger shall ensure a QSP ensure that the REAP include, at a minimum, the following site information:
 - a. Site Address.
 - b. Calculated Risk Level (2 or 3).
 - c. Site Storm Water Manager Information including the name, company, and 24-hour emergency telephone number.
 - d. Erosion and Sediment Control Provider information including the name, company, and 24-hour emergency telephone number.
 - e. Storm Water Sampling Agent information including the name, company, and 24-hour emergency telephone number.
4. **Additional Risk Level 3 Requirement:** The QSP shall include in the REAP, at a minimum, the following project phase information:
 - a. Activities associated with each construction phase.
 - b. Trades active on the construction site during each construction phase.
 - c. Trade contractor information.
 - d. Suggested actions for each project phase.
5. **Additional Risk Level 3 Requirement:** The QSP shall develop additional REAPs for project sites where construction activities are indefinitely halted or postponed (Inactive Construction). At a minimum, Inactive Construction REAPs must include:

- a. Site Address.
 - b. Calculated Risk Level (2 or 3).
 - c. Site Storm Water Manager Information including the name, company, and 24-hour emergency telephone number.
 - d. Erosion and Sediment Control Provider information including the name, company, and 24-hour emergency telephone number.
 - e. Storm Water Sampling Agent information including the name, company, and 24-hour emergency telephone number.
 - f. Trades active on site during Inactive Construction.
 - g. Trade contractor information.
 - h. Suggested actions for inactive construction sites.
6. **Additional Risk Level 3 Requirement:** The discharger shall ensure a QSP begin implementation and make the REAP available onsite no later than 24 hours prior to the likely precipitation event.
7. **Additional Risk Level 3 Requirement:** The discharger shall ensure a QSP maintain onsite a paper copy of each REAP onsite in compliance with the record retention requirements of the Special Provisions in this General Permit.

I. Risk Level 3 Monitoring and Reporting Requirements

Table 2- Summary of Monitoring Requirements

Risk Level	Visual Inspections					Sample Collection	
	Quarterly Non-storm Water Discharge	Pre-storm Event		Daily Storm BMP	Post Storm	Storm Water Discharge	Receiving Water
		Baseline	REAP				
3	X	X	X	X	X	X	X⁴

1. Construction Site Monitoring Program Requirements

- a. Pursuant to Water Code Sections 13383 and 13267, all dischargers subject to this General Permit shall develop and implement a written site-specific Construction Site Monitoring Program (CSMP) in accordance with the requirements of this Section. The CSMP shall include all monitoring procedures and instructions, location maps, forms, and checklists as required in this section. The CSMP shall be developed prior to the commencement of construction activities, and revised as necessary to reflect project revisions. The CSMP shall be a part of the Storm Water Pollution Prevention Plan (SWPPP), included as an appendix or separate SWPPP chapter.
- b. Existing dischargers registered under the State Water Board Order No. 99-08-DWQ shall make and implement necessary revisions to their Monitoring Program to reflect the changes in this General Permit in a timely manner, but no later than July 1, 2010. Existing dischargers shall continue to implement their existing Monitoring Program in compliance with State Water Board Order No. 99-08-DWQ until the necessary revisions are completed according to the schedule above.
- c. When a change of ownership occurs for all or any portion of the construction site prior to completion or final stabilization, the new discharger shall comply with these requirements as of the date the ownership change occurs.

2. Objectives

The CSMP shall be developed and implemented to address the following objectives:

⁴ When receiving water monitoring trigger is exceeded

- a. To demonstrate that the site is in compliance with the Discharge Prohibitions and applicable Numeric Action Levels (NALs) of this General Permit.
 - b. To determine whether non-visible pollutants are present at the construction site and are causing or contributing to exceedances of water quality objectives.
 - c. To determine whether immediate corrective actions, additional Best Management Practice (BMP) implementation, or SWPPP revisions are necessary to reduce pollutants in storm water discharges and authorized non-storm water discharges.
 - d. To determine whether BMPs included in the SWPPP/Rain Event Action Plan (REAP) are effective in preventing or reducing pollutants in storm water discharges and authorized non-storm water discharges.
- 3. Risk Level 3 – Visual Monitoring (Inspection) Requirements for Qualifying Rain Events**
- a. Risk Level 3 dischargers shall visually observe (inspect) storm water discharges at all discharge locations within two business days (48 hours) after each qualifying rain event.
 - b. Risk Level 3 dischargers shall visually observe (inspect) the discharge of stored or contained storm water that is derived from and discharged subsequent to a qualifying rain event producing precipitation of ½ inch or more at the time of discharge. Stored or contained storm water that will likely discharge after operating hours due to anticipated precipitation shall be observed prior to the discharge during operating hours.
 - c. Risk Level 3 dischargers shall conduct visual observations (inspections) during business hours only.
 - d. Risk Level 3 dischargers shall record the time, date and rain gauge reading of all qualifying rain events.
 - e. Within 2 business days (48 hours) prior to each qualifying rain event, Risk Level 3 dischargers shall visually observe (inspect):
 - i. all storm water drainage areas to identify any spills, leaks, or uncontrolled pollutant sources. If needed, the discharger shall implement appropriate corrective actions.

- ii. all BMPs to identify whether they have been properly implemented in accordance with the SWPPP/REAP. If needed, the discharger shall implement appropriate corrective actions.
 - iii. any storm water storage and containment areas to detect leaks and ensure maintenance of adequate freeboard.
- f. For the visual observations (inspections) described in c.i. and c.iii above, Risk Level 3 dischargers shall observe the presence or absence of floating and suspended materials, a sheen on the surface, discolorations, turbidity, odors, and source(s) of any observed pollutants.
 - g. Within two business days (48 hours) after each qualifying rain event, Risk Level 3 dischargers shall conduct post rain event visual observations (inspections) to (1) identify whether BMPs were adequately designed, implemented, and effective, and (2) identify additional BMPs and revise the SWPPP accordingly.
 - h. Risk Level 3 dischargers shall maintain on-site records of all visual observations (inspections), personnel performing the observations, observation dates, weather conditions, locations observed, and corrective actions taken in response to the observations.

4. Risk Level 3 – Water Quality Sampling and Analysis

- a. Risk Level 3 dischargers shall collect storm water grab samples from sampling locations, as defined in Section I.5. The storm water grab sample(s) obtained shall be representative of the flow and characteristics of the discharge.
- b. At minimum, Risk Level 3 dischargers shall collect 3 samples per day of the qualifying event.
- c. Risk Level 3 dischargers shall ensure that the grab samples collected of stored or contained storm water are from discharges subsequent to a qualifying rain event (producing precipitation of ½ inch or more at the time of discharge).

Storm Water Effluent Monitoring Requirements

- d. Risk Level 3 dischargers shall analyze their effluent samples for:
 - i. pH and turbidity.

- ii. Any additional parameters for which monitoring is required by the Regional Water Board.
- e. Risk 3 dischargers shall electronically submit all storm event sampling results to the State Water Board no later than 10 days after the conclusion of the storm event.

Receiving Water Monitoring Requirements

- f. In the event that a Risk Level 3 discharger's effluent exceeds the daily average receiving water monitoring trigger of 500 NTU turbidity or the daily average pH range 6.0-9.0 contained in this General Permit and has a direct discharge into receiving waters, the Risk Level 3 discharger shall subsequently sample receiving waters (RWs) for turbidity, pH (if applicable), and SSC for the duration of coverage under this General Permit. If a Risk Level 3 discharger utilizing ATS with direct discharges into receiving waters discharges effluent that exceeds the NELs in this permit, the discharger shall subsequently sample RWs for turbidity, pH (if applicable), and SSC for the duration of coverage under this General Permit.
- g. Risk Level 3 dischargers disturbing 30 acres or more of the landscape and with direct discharges into receiving waters shall conduct or participate in benthic macroinvertebrate bioassessment of RWs prior to commencement of construction activity (See Appendix 3).
- h. Risk Level 3 dischargers shall obtain RW samples in accordance with the Receiving Water sampling location section (Section I.5), below.

5. Risk Level 3 – Storm Water Discharge Water Quality Sampling Locations

Effluent Sampling Locations

- a. Risk Level 3 dischargers shall perform sampling and analysis of storm water discharges to characterize discharges associated with construction activity from the entire project disturbed area.
- b. Risk Level 3 dischargers shall collect effluent samples at all discharge points where storm water is discharged off-site.

- c. Risk Level 3 dischargers shall ensure that storm water discharge collected and observed represent⁵ the effluent in each drainage area based on visual observation of the water and upstream conditions.
- d. Risk Level 3 dischargers shall monitor and report site run-on from surrounding areas if there is reason to believe run-on may contribute to an exceedance of NALs.
- e. Risk Level 3 dischargers who deploy an ATS on their site, or a portion on their site, shall collect ATS effluent samples and measurements from the discharge pipe or another location representative of the nature of the discharge.
- f. Risk Level 3 dischargers shall select analytical test methods from the list provided in Table 3 below.
- g. All storm water sample collection preservation and handling shall be conducted in accordance with Section 1.7 “Storm Water Sample Collection and Handling Instructions” below.

Receiving Water Sampling Locations

- h. **Upstream/up-gradient RW samples:** Risk Level 3 dischargers shall obtain any required upstream/up-gradient receiving water samples from a representative and accessible location as close as possible and upstream from the effluent discharge point.
- i. **Downstream/down-gradient RW samples:** Risk Level 3 dischargers shall obtain any required downstream/down-gradient receiving water samples from a representative and accessible location as close as possible and downstream from the effluent discharge point.
- j. If two or more discharge locations discharge to the same receiving water, Risk Level 3 dischargers may sample the receiving water at a single upstream and downstream location.

⁵ For example, if there has been concrete work recently in an area, or drywall scrap is exposed to the rain, a pH sample shall be taken of drainage from the relevant work area. Similarly, if sediment-laden water is flowing through some parts of a silt fence, samples shall be taken of the sediment laden water even if most water flowing through the fence is clear.

6. Risk Level 3 – Visual Observation and Sample Collection Exemptions

- a. Risk Level 3 dischargers shall be prepared to collect samples and conduct visual observation (inspections) until the minimum requirements of Sections I.3 and I.4 above are completed. Risk Level 3 dischargers are not required to physically collect samples or conduct visual observation (inspections) under the following conditions:
 - i. During dangerous weather conditions such as flooding and electrical storms.
 - ii. Outside of scheduled site business hours.
- b. If no required samples or visual observation (inspections) are collected due to these exceptions, Risk Level 3 dischargers shall include an explanation in their SWPPP and in the Annual Report documenting why the sampling or visual observation (inspections) were not conducted.

7. Risk Level 3 – Storm Water Sample Collection and Handling Instructions

- a. Risk Level 3 dischargers shall refer to Table 3 below for test methods, detection limits, and reporting units.
- b. Risk Level 3 dischargers shall ensure that testing laboratories will receive samples within 48 hours of the physical sampling (unless otherwise required by the laboratory), and shall use only the sample containers provided by the laboratory to collect and store samples.
- c. Risk Level 3 dischargers shall designate and train personnel to collect, maintain, and ship samples in accordance with the Surface Water Ambient Monitoring Program's (SWAMP) 2008 Quality Assurance Program Plan (QAPrP).⁶

⁶ Additional information regarding SWAMP's QAPrP can be found at http://www.waterboards.ca.gov/water_issues/programs/swamp/.

QAPrP:http://www.waterboards.ca.gov/water_issues/programs/swamp/docs/qapp/swamp_qapp_master090108a.pdf

8. Risk Level 3 – Monitoring Methods

- a. Risk Level 3 dischargers shall include a description of the following items in the CSMP:
 - i. Visual observation locations, visual observation procedures, and visual observation follow-up and tracking procedures.
 - ii. Sampling locations, and sample collection and handling procedures. This shall include detailed procedures for sample collection, storage, preservation, and shipping to the testing lab to assure that consistent quality control and quality assurance is maintained. Dischargers shall attach to the monitoring program an example Chain of Custody form used when handling and shipping samples.
 - iii. Identification of the analytical methods and related method detection limits (if applicable) for each parameter required in Section I.4 above.
- b. Risk Level 3 dischargers shall ensure that all sampling and sample preservation are in accordance with the current edition of "Standard Methods for the Examination of Water and Wastewater" (American Public Health Association). All monitoring instruments and equipment (including a discharger's own field instruments for measuring pH and turbidity) should be calibrated and maintained in accordance with manufacturers' specifications to ensure accurate measurements. Risk Level 3 dischargers shall ensure that all laboratory analyses are conducted according to test procedures under 40 CFR Part 136, unless other test procedures have been specified in this General Permit or by the Regional Water Board. With the exception of field analysis conducted by the discharger for turbidity and pH, all analyses should be sent to and conducted at a laboratory certified for such analyses by the State Department of Health Services (SSC exception). Risk Level 3 dischargers shall conduct their own field analysis of pH and may conduct their own field analysis of turbidity if the discharger has sufficient capability (qualified and trained employees, properly calibrated and maintained field instruments, etc.) to adequately perform the field analysis.

9. Risk Level 3 – Analytical Methods

- a. Risk Level 3 dischargers shall refer to Table 3 below for test methods, detection limits, and reporting units.

- b. **pH:** Risk Level 3 dischargers shall perform pH analysis on-site with a calibrated pH meter or a pH test kit. Risk Level 3 dischargers shall record pH monitoring results on paper and retain these records in accordance with Section I.14, below.
- c. **Turbidity:** Risk Level 3 dischargers shall perform turbidity analysis using a calibrated turbidity meter (turbidimeter), either on-site or at an accredited lab. Acceptable test methods include Standard Method 2130 or USEPA Method 180.1. The results will be recorded in the site log book in Nephelometric Turbidity Units (NTU).
- d. **Suspended sediment concentration (SSC):** Risk Level 3 dischargers that exceed the turbidity Receiving Water Monitoring Trigger shall perform SSC analysis using ASTM Method D3977-97.
- e. **Bioassessment:** Risk Level 3 dischargers shall perform bioassessment sampling and analysis according to Appendix 3 of this General Permit.

10. Risk Level 3 - Non-Storm Water Discharge Monitoring Requirements

- a. Visual Monitoring Requirements:
 - i. Risk Level 3 dischargers shall visually observe (inspect) each drainage area for the presence of (or indications of prior) unauthorized and authorized non-storm water discharges and their sources.
 - ii. Risk Level 3 dischargers shall conduct one visual observation (inspection) quarterly in each of the following periods: January-March, April-June, July-September, and October-December. Visual observation (inspections) are only required during daylight hours (sunrise to sunset).
 - iii. Risk Level 3 dischargers shall ensure that visual observations (inspections) document the presence or evidence of any non-storm water discharge (authorized or unauthorized), pollutant characteristics (floating and suspended material, sheen, discoloration, turbidity, odor, etc.), and source. Risk Level 3 dischargers shall maintain on-site records indicating the personnel performing the visual observation (inspections), the dates and approximate time each drainage area and non-storm water discharge was observed, and the response taken to eliminate unauthorized non-storm water discharges and to

reduce or prevent pollutants from contacting non-storm water discharges.

- b. Effluent Sampling Locations:
 - i. Risk Level 3 dischargers shall sample effluent at all discharge points where non-storm water and/or authorized non-storm water is discharged off-site.
 - ii. Risk Level 3 dischargers shall send all non-storm water sample analyses to a laboratory certified for such analyses by the State Department of Health Services.
 - iii. Risk Level 3 dischargers shall monitor and report run-on from surrounding areas if there is reason to believe run-on may contribute to an exceedance of NALs.

11. Risk Level 3 – Non-Visible Pollutant Monitoring Requirements

- a. Risk Level 3 dischargers shall collect one or more samples during any breach, malfunction, leakage, or spill observed during a visual inspection which could result in the discharge of pollutants to surface waters that would not be visually detectable in storm water.
- b. Risk Level 3 dischargers shall ensure that water samples are large enough to characterize the site conditions.
- c. Risk Level 3 dischargers shall collect samples at all discharge locations that can be safely accessed.
- d. Risk Level 3 dischargers shall collect samples during the first two hours of discharge from rain events that occur during business hours and which generate runoff.
- e. Risk Level 3 dischargers shall analyze samples for all non-visible pollutant parameters (if applicable) - parameters indicating the presence of pollutants identified in the pollutant source assessment required (Risk Level 3 dischargers shall modify their CSMPs to address these additional parameters in accordance with any updated SWPPP pollutant source assessment).
- f. Risk Level 3 dischargers shall collect a sample of storm water that has not come in contact with the disturbed soil or the materials stored or used on-site (uncontaminated sample) for comparison with the discharge sample.

- g. Risk Level 3 dischargers shall compare the uncontaminated sample to the samples of discharge using field analysis or through laboratory analysis.⁷
- h. Risk Level 3 dischargers shall keep all field /or analytical data in the SWPPP document.

12. Risk Level 3 – Watershed Monitoring Option

Risk Level 3 dischargers who are part of a qualified regional watershed-based monitoring program may be eligible for relief from the requirements in Sections I.5. The Regional Water Board may approve proposals to substitute an acceptable watershed-based monitoring program by determining if the watershed-based monitoring program will provide substantially similar monitoring information in evaluating discharger compliance with the requirements of this General Permit.

13. Risk Level 3 – Particle Size Analysis for Project Risk Justification

Risk Level 3 dischargers justifying an alternative project risk shall report a soil particle size analysis used to determine the RUSLE K-Factor. ASTM D-422 (Standard Test Method for Particle-Size Analysis of Soils), as revised, shall be used to determine the percentages of sand, very fine sand, silt, and clay on the site.

14. Risk Level 3 – Records

Risk Level 3 dischargers shall retain records of all storm water monitoring information and copies of all reports (including Annual Reports) for a period of at least three years. Risk Level 3 dischargers shall retain all records on-site while construction is ongoing. These records include:

- a. The date, place, time of facility inspections, sampling, visual observation (inspections), and/or measurements, including precipitation.
- b. The individual(s) who performed the facility inspections, sampling, visual observation (inspections), and or measurements.
- c. The date and approximate time of analyses.

⁷ For laboratory analysis, all sampling, sample preservation, and analyses must be conducted according to test procedures under 40 CFR Part 136. Field discharge samples shall be collected and analyzed according to the specifications of the manufacturer of the sampling devices employed.

- d. The individual(s) who performed the analyses.
- e. A summary of all analytical results from the last three years, the method detection limits and reporting units, the analytical techniques or methods used, and the chain of custody forms.
- f. Rain gauge readings from site inspections.
- g. Quality assurance/quality control records and results.
- h. Non-storm water discharge inspections and visual observation (inspections) and storm water discharge visual observation records (see Sections I.3 and I.10 above).
- i. Visual observation and sample collection exception records (see Section I.6 above).
- j. The records of any corrective actions and follow-up activities that resulted from analytical results, visual observation (inspections), or inspections.

15. Risk Level 3 – NAL Exceedance Report

- a. Risk Level 3 dischargers shall electronically submit all storm event sampling results to the State Water Board no later than 10 days after the conclusion of the storm event. The Regional Boards have the authority to require the submittal of an NAL Exceedance Report.
- b. Risk Level 3 dischargers shall certify each NAL Exceedance Report in accordance with the Special Provisions for Construction Activity In this General Permit.
- c. Risk Level 3 dischargers shall retain an electronic or paper copy of each NAL Exceedance Report for a minimum of three years after the date the annual report is filed.
- d. Risk Level 3 dischargers shall include in the NAL Exceedance Report:
 - i. The analytical method(s), method reporting unit(s), and method detection limit(s) of each analytical parameter (analytical results that are less than the method detection limit shall be reported as “less than the method detection limit”).

- ii. The date, place, time of sampling, visual observation (inspections), and/or measurements, including precipitation.
- iii. A description of the current BMPs associated with the effluent sample that exceeded the NAL and the proposed corrective actions taken.

16. Risk Level 3 – Bioassessment

- a. Risk Level 3 dischargers with a total project-related ground disturbance exceeding 30 acres shall:
 - i. Conduct bioassessment monitoring, as described in Appendix 3.
 - ii. Include the collection and reporting of specified in stream biological data and physical habitat.
 - iii. Use the bioassessment sample collection and Quality Assurance & Quality Control (QA/QC) protocols developed by the State of California's Surface Water Ambient Monitoring Program (SWAMP).⁸
 - b. Risk Level 3 dischargers qualifying for bioassessment, where construction commences out of an index period for the site location shall:
 - i. Receive Regional Board approval for the sampling exception.
 - ii. Conduct bioassessment monitoring, as described in Appendix 3.
 - iii. Include the collection and reporting of specified instream biological data and physical habitat.
 - iv. Use the bioassessment sample collection and Quality Assurance & Quality Control (QA/QC) protocols developed by the State of California's Surface Water Ambient Monitoring Program (SWAMP).
- OR
- v. Make a check payable to: Cal State Chico Foundation (SWAMP Bank Account) or San Jose State Foundation (SWAMP Bank Account) and include the WDID# on the check for the amount calculated for the exempted project.

⁸ http://www.waterboards.ca.gov/water_issues/programs/swamp/.

- vi. Send a copy of the check to the Regional Water Board office for the site's region.
- vii. Invest **\$7,500.00 X The number of samples required** into the SWAMP program as compensation (upon regional board approval).

Table 3 – Risk Level 3 Test Methods, Detection Limits, Reporting Units and Applicable NALs

Parameter	Test Method / Protocol	Discharge Type	Min. Detection Limit	Reporting Units	Numeric Action Level	Numeric Effluent Limitation	Receiving Water Monitoring Trigger
pH	Field test with calibrated portable instrument	Risk Level 3 Discharges	0.2	pH units	lower NAL = 6.5 upper NAL = 8.5	N/A	lower limit = 6.0 upper limit = 9.0
Turbidity	EPA 0180.1 and/or field test with calibrated portable instrument	Risk Level 3 Discharges other than ATS	1	NTU	250 NTU	N/A	500 NTU
		For ATS discharges	1	NTU	N/A	10 NTU for Daily Weighted Average & 20 NTU for Any Single Sample	10 NTU for Daily Weighted Average & 20 NTU for Any Single Sample
SSC	ASTM Method D 3977-97 ⁹	Risk Level 3 (if Receiving Water Monitoring Trigger exceeded)	5	mg/L	N/A	N/A	N/A
Bioassessment	(STE) Level I of (SAFIT), ¹⁰ fixed-count of 600 org/sample	Risk Level 3 projects > 30 acres	N/A	N/A	N/A	N/A	N/A

⁹ ASTM, 1999, Standard Test Method for Determining Sediment Concentration in Water Samples: American Society of Testing and Materials, D 3977-97, Vol. 11.02, pp. 389-394.

¹⁰ The current SAFIT STEs (28 November 2006) list requirements for both the Level I and Level II taxonomic effort, and are located at: http://www.swrcb.ca.gov/swamp/docs/safit/ste_list.pdf. When new editions are published by SAFIT, they will supersede all previous editions. All editions will be posted at the State Water Board's SWAMP website.

ATTACHMENT F: Active Treatment System (ATS) Requirements

Table 1 – Numeric Effluent Limitations, Numeric Action Levels, Test Methods, Detection Limits, and Reporting Units

Parameter	Test Method	Discharge Type	Min. Detection Limit	Units	Numeric Action Level	Numeric Effluent Limitation
Turbidity	EPA 0180.1 and/or field test with a calibrated portable instrument	For ATS discharges	1	NTU	N/A	10 NTU for Daily Flow-Weighted Average & 20 NTU for Any Single Sample

A. Dischargers choosing to implement an Active Treatment System (ATS) on their site shall comply with all of the requirements in this Attachment.

B. The discharger shall maintain a paper copy of each ATS specification onsite in compliance with the record retention requirements in the Special Provisions of this General Permit.

C. ATS Design, Operation and Submittals

1. The ATS shall be designed and approved by a Certified Professional in Erosion and Sediment Control (CPESC), a Certified Professional in Storm Water Quality (CPSWQ); a California registered civil engineer; or any other California registered engineer.
2. The discharger shall ensure that the ATS is designed in a manner to preclude the accidental discharge of settled floc¹ during floc pumping or related operations.
3. The discharger shall design outlets to dissipate energy from concentrated flows.
4. The discharger shall install and operate an ATS by assigning a lead person (or project manager) who has either a minimum of five years construction storm

¹ Floc is defined as a clump of solids formed by the chemical action in ATS systems.

water experience or who is a licensed contractors specifically holding a California Class A Contractors license.²

5. The discharger shall prepare an ATS Plan that combines the site-specific data and treatment system information required to safely and efficiently operate an ATS. The ATS Plan shall be electronically submitted to the State Water Board at least 14 days prior to the planned operation of the ATS and a paper copy shall be available onsite during ATS operation. At a minimum, the ATS Plan shall include:
 - a. ATS Operation and Maintenance Manual for All Equipment.
 - b. ATS Monitoring, Sampling & Reporting Plan, including Quality Assurance/Quality Control (QA/QC).
 - c. ATS Health and Safety Plan.
 - d. ATS Spill Prevention Plan.
6. The ATS shall be designed to capture and treat (within a 72-hour period) a volume equivalent to the runoff from a 10-year, 24-hour storm event using a watershed runoff coefficient of 1.0.

D. Treatment – Chemical Coagulation/Flocculation

1. Jar tests shall be conducted using water samples selected to represent typical site conditions and in accordance with ASTM D2035-08 (2003).
2. The discharger shall conduct, at minimum, six site-specific jar tests (per polymer with one test serving as a control) for each project to determine the proper polymer and dosage levels for their ATS.
3. Single field jar tests may also be conducted during a project if conditions warrant, for example if construction activities disturb changing types of soils, which consequently cause change in storm water and runoff characteristics.

E. Residual Chemical and Toxicity Requirements

1. The discharger shall utilize a residual chemical test method that has a method detection limit (MDL) of 10% or less than the maximum allowable threshold

² Business and Professions Code Division 3, Chapter 9, Article 4, Class A Contractor: A general engineering contractor is a contractor whose principal contracting business is in connection with fixed works requiring specialized engineering knowledge and skill. [<http://www.cslb.ca.gov/General-Information/library/licensing-classifications.asp>].

concentration³ (MATC) for the specific coagulant in use and for the most sensitive species of the chemical used.

2. The discharger shall utilize a residual chemical test method that produces a result within one hour of sampling.
3. The discharger shall have a California State certified laboratory validate the selected residual chemical test. Specifically the lab will review the test protocol, test parameters, and the detection limit of the coagulant. The discharger shall electronically submit this documentation as part of the ATS Plan.
4. If the discharger cannot utilize a residual chemical test method that meets the requirements above, the discharger shall operate the ATS in Batch Treatment⁴ mode.
5. A discharger planning to operate in Batch Treatment mode shall perform toxicity testing in accordance with the following:
 - a. The discharger shall initiate acute toxicity testing on effluent samples representing effluent from each batch prior to discharge⁵. All bioassays shall be sent to a laboratory certified by the Department of Health Services (DHS) Environmental Laboratory Accreditation Program (ELAP). The required field of testing number for Whole Effluent Toxicity (WET) testing is E113.⁶
 - b. Acute toxicity tests shall be conducted with the following species and protocols. The methods to be used in the acute toxicity testing shall be those outlined for a 96-hour acute test in "Methods for Measuring the Acute Toxicity of Effluents and Receiving Water to Freshwater and Marine Organisms, USEPA-841-R-02-012" for Fathead minnow, *Pimephales promelas* (fathead minnow). Acute toxicity for *Oncorhynchus mykiss* (Rainbow Trout) may be used as a substitute for testing fathead minnows.
 - c. All toxicity tests shall meet quality assurance criteria and test acceptability criteria in the most recent versions of the EPA test method for WET testing.
 - d. The discharger shall electronically report all acute toxicity testing.

³ The Maximum Allowable Threshold Concentration (MATC) is the allowable concentration of residual, or dissolved, coagulant/flocculant in effluent. The MATC shall be coagulant/flocculant-specific, and based on toxicity testing conducted by an independent, third-party laboratory. A typical MATC would be: The MATC is equal to the geometric mean of the NOEC (No Observed Effect Concentration) and LOEC (Lowest Observed Effect Concentration) Acute and Chronic toxicity results for most sensitive species determined for the specific coagulant. The most sensitive species test shall be used to determine the MATC.

⁴ Batch Treatment mode is defined as holding or recirculating the treated water in a holding basin or tank(s) until treatment is complete or the basin or storage tank(s) is full.

⁵ This requirement only requires that the test be initiated prior to discharge.

⁶ http://www.dhs.ca.gov/ps/ls/elap/pdf/FOT_Desc.pdf.

F. Filtration

1. The ATS shall include a filtration step between the coagulant treatment train and the effluent discharge. This is commonly provided by sand, bag, or cartridge filters, which are sized to capture suspended material that might pass through the clarifier tanks.
2. Differential pressure measurements shall be taken to monitor filter loading and confirm that the final filter stage is functioning properly.

G. Residuals Management

1. Sediment shall be removed from the storage or treatment cells as necessary to ensure that the cells maintain their required water storage (i.e., volume) capability.
2. Handling and disposal of all solids generated during ATS operations shall be done in accordance with all local, state, and federal laws and regulations.

H. ATS Instrumentation

1. The ATS shall be equipped with instrumentation that automatically measures and records effluent water quality data and flow rate.
2. The minimum data recorded shall be consistent with the Monitoring and Reporting requirements below, and shall include:
 - a. Influent Turbidity
 - b. Effluent Turbidity
 - c. Influent pH
 - d. Effluent pH
 - e. Residual Chemical
 - f. Effluent Flow rate
 - g. Effluent Flow volume
3. Systems shall be equipped with a data recording system, such as data loggers or webserver-based systems, which records each measurement on a frequency no longer than once every 15 minutes.

4. Cumulative flow volume shall be recorded daily. The data recording system shall have the capacity to record a minimum of seven days continuous data.
5. Instrumentation systems shall be interfaced with system control to provide auto shutoff or recirculation in the event that effluent measurements exceed turbidity or pH.
6. The system shall also assure that upon system upset, power failure, or other catastrophic event, the ATS will default to a recirculation mode or safe shut down.
7. Instrumentation (flow meters, probes, valves, streaming current detectors, controlling computers, etc.) shall be installed and maintained per manufacturer's recommendations, which shall be included in the QA/QC plan.
8. The QA/QC plan shall also specify calibration procedures and frequencies, instrument method detection limit or sensitivity verification, laboratory duplicate procedures, and other pertinent procedures.
9. The instrumentation system shall include a method for controlling coagulant dose, to prevent potential overdosing. Available technologies include flow/turbidity proportional metering, periodic jar testing and metering pump adjustment, and ionic charge measurement controlling the metering pump.

I. ATS Effluent Discharge

1. ATS effluent shall comply with all provisions and prohibitions in this General Permit, specifically the NELs.
2. NELs for discharges from an ATS:
 - a. Turbidity of all ATS discharges shall be less than 10 NTU for daily flow-weighted average of all samples and 20 NTU for any single sample.
 - b. Residual Chemical shall be < 10% of MATC⁷ for the most sensitive species of the chemical used.

⁷ The Maximum Allowable Threshold Concentration (MATC) is the allowable concentration of residual, or dissolved, coagulant/flocculant in effluent. The MATC shall be coagulant/flocculant-specific, and based on toxicity testing conducted by an independent, third-party laboratory. The MATC is equal to the geometric mean of the NOEC (No Observed Effect Concentration) and LOEC (Lowest Observed Effect Concentration) Acute and Chronic toxicity results for most sensitive species determined for the specific coagulant. The most sensitive species test shall be used to determine the MATC.

3. If an analytical effluent sampling result exceeds the turbidity NEL (as listed in Table 1), the discharger is in violation of this General Permit and shall electronically file the results in violation within 24-hours of obtaining the results.
4. If ATS effluent is authorized to discharge into a sanitary sewer system, the discharger shall comply with any pre-treatment requirements applicable for that system. The discharger shall include any specific criteria required by the municipality in the ATS Plan.
5. Compliance Storm Event:

Discharges of storm water from ATS shall comply with applicable NELs (above) unless the storm event causing the discharges is determined after the fact to be equal to or larger than the Compliance Storm Event (expressed in inches of rainfall). The Compliance Storm Event for ATS discharges is the 10 year, 24 hour storm, as determined using these maps:

<http://www.wrcc.dri.edu/pcpnfreq/nca10y24.gif>
<http://www.wrcc.dri.edu/pcpnfreq/sca10y24.gif>

This exemption is dependent on the submission of rain gauge data verifying the storm event is equal to or larger than the Compliance Storm.

J. Operation and Maintenance Plan

1. Each Project shall have a site-specific Operation and Maintenance (O&M) Manual covering the procedures required to install, operate and maintain the ATS.⁸
2. The O&M Manual shall only be used in conjunction with appropriate project-specific design specifications that describe the system configuration and operating parameters.
3. The O&M Manual shall have operating manuals for specific pumps, generators, control systems, and other equipment.

K. Sampling and Reporting Quality Assurance/ Quality Check (QA/QC) Plan

4. A project-specific QA/QC Plan shall be developed for each project. The QA/QC Plan shall include at a minimum:
 - a. Calibration – Calibration methods and frequencies for all system and field instruments shall be specified.

⁸ The manual is typically in a modular format covering generalized procedures for each component that is utilized in a particular system.

- b. Method Detection Limits (MDLs) – The methods for determining MDLs shall be specified for each residual coagulant measurement method. Acceptable minimum MDLs for each method, specific to individual coagulants, shall be specified.
- c. Laboratory Duplicates – Requirements for monthly laboratory duplicates for residual coagulant analysis shall be specified.

L. Personnel Training

- 1. Operators shall have training specific to using an ATS and liquid coagulants for storm water discharges in California.
- 2. The training shall be in the form of a formal class with a certificate and requirements for testing and certificate renewal.
- 3. Training shall include a minimum of eight hours classroom and 32 hours field training. The course shall cover the following topics:
 - a. Coagulation Basics –Chemistry and physical processes
 - b. ATS System Design and Operating Principles
 - c. ATS Control Systems
 - d. Coagulant Selection – Jar testing, dose determination, etc.
 - e. Aquatic Safety/Toxicity of Coagulants, proper handling and safety
 - f. Monitoring, Sampling, and Analysis
 - g. Reporting and Recordkeeping
 - h. Emergency Response

M. Active Treatment System (ATS) Monitoring Requirements

Any discharger who deploys an ATS on their site shall conduct the following:

- 1. Visual Monitoring
 - a. A designated responsible person shall be on site daily at all times during treatment operations.

- b. Daily on-site visual monitoring of the system for proper performance shall be conducted and recorded in the project data log.
 - i. The log shall include the name and phone number of the person responsible for system operation and monitoring.
 - ii. The log shall include documentation of the responsible person's training.

2. Operational and Compliance Monitoring

- a. Flow shall be continuously monitored and recorded at not greater than 15-minute intervals for total volume treated and discharged.
- b. Influent and effluent pH must be continuously monitored and recorded at not greater than 15-minute intervals.
- c. Influent and effluent turbidity (expressed in NTU) must be continuously monitored and recorded at not greater than 15-minute intervals.
- d. The type and amount of chemical used for pH adjustment, if any, shall be monitored and recorded.
- e. Dose rate of chemical used in the ATS system (expressed in mg/L) shall be monitored and reported 15-minutes after startup and every 8 hours of operation.
- f. Laboratory duplicates – monthly laboratory duplicates for residual coagulant analysis must be performed and records shall be maintained onsite.
- g. Effluent shall be monitored and recorded for residual chemical/additive levels.
- h. If a residual chemical/additive test does not exist and the ATS is operating in a batch treatment mode of operation refer to the toxicity monitoring requirements below.

3. Toxicity Monitoring

A discharger operating in batch treatment mode shall perform toxicity testing in accordance with the following:

- a. The discharger shall initiate acute toxicity testing on effluent samples representing effluent from each batch prior to discharge.⁹ All bioassays shall be sent to a laboratory certified by the Department of Health Services (DHS)

⁹ This requirement only requires that the test be initiated prior to discharge.

Environmental Laboratory Accreditation Program (ELAP). The required field of testing number for Whole Effluent Toxicity (WET) testing is E113.¹⁰

- b. Acute toxicity tests shall be conducted with the following species and protocols. The methods to be used in the acute toxicity testing shall be those outlined for a 96-hour acute test in “Methods for Measuring the Acute Toxicity of Effluents and Receiving Water to Freshwater and Marine Organisms, USEPA-841-R-02-012” for Fathead minnow, *Pimephales promelas* or Rainbow trout *Oncorhynchus mykiss* may be used as a substitute for fathead minnow.
- c. All toxicity tests shall meet quality assurance criteria and test acceptability criteria in the most recent versions of the EPA test method for WET testing.¹¹

4. Reporting and Recordkeeping

At a minimum, every 30 days a LRP representing the discharger shall access the State Water Boards Storm Water Multi-Application and Report Tracking system (SMARTS) and electronically upload field data from the ATS. Records must be kept for three years after the project is completed .

5. Non-compliance Reporting

- a. Any indications of toxicity or other violations of water quality objectives shall be reported to the appropriate regulatory agency as required by this General Permit.
- b. Upon any measurements that exceed water quality standards, the system operator shall immediately notify his supervisor or other responsible parties, who shall notify the Regional Water Board.
- c. If any monitoring data exceeds any applicable NEL in this General Permit, the discharger shall electronically submit a NEL Violation Report to the State Water Board within 24 hours after the NEL exceedance has been identified.
 - i. ATS dischargers shall certify each NEL Violation Report in accordance with the Special Provisions for Construction Activity in this General Permit.
 - ii. ATS dischargers shall retain an electronic or paper copy of each NEL Violation Report for a minimum of three years after the date the annual report is filed.
 - iii. ATS dischargers shall include in the NEL Violation Report:

¹⁰ http://www.dhs.ca.gov/ps/ls/elap/pdf/FOT_Desc.pdf.

¹¹ <http://www.epa.gov/waterscience/methods/wet/>.

- (1) The analytical method(s), method reporting unit(s), and method detection limit(s) of each analytical parameter (analytical results that are less than the method detection limit shall be reported as “less than the method detection limit”);
 - (2) The date, place, time of sampling, visual observation (inspections), and/or measurements, including precipitation; and
 - (3) A description of the current onsite BMPs, and the proposed corrective actions taken to manage the NEL exceedance.
- iv. Compliance Storm Exemption - In the event that an applicable NEL has been exceeded during a storm event equal to or larger than the Compliance Storm Event, ATS dischargers shall report the on-site rain gauge reading and nearby governmental rain gauge readings for verification.

	A	B	C
1	Sediment Risk Factor Worksheet		Entry
2	A) R Factor		
3	Analyses of data indicated that when factors other than rainfall are held constant, soil loss is directly proportional to a rainfall factor composed of total storm kinetic energy (E) times the maximum 30-min intensity (I30) (Wischmeier and Smith, 1958). The numerical value of R is the average annual sum of EI30 for storm events during a rainfall record of at least 22 years. "Isoerodent" maps were developed based on R values calculated for more than 1000 locations in the Western U.S. Refer to the link below to determine the R factor for the project site.		
4	http://cfpub.epa.gov/npdes/stormwater/LEW/lewCalculator.cfm		
5		R Factor Value	0
6	B) K Factor (weighted average, by area, for all site soils)		
7	The soil-erodibility factor K represents: (1) susceptibility of soil or surface material to erosion, (2) transportability of the sediment, and (3) the amount and rate of runoff given a particular rainfall input, as measured under a standard condition. Fine-textured soils that are high in clay have low K values (about 0.05 to 0.15) because the particles are resistant to detachment. Coarse-textured soils, such as sandy soils, also have low K values (about 0.05 to 0.2) because of high infiltration resulting in low runoff even though these particles are easily detached. Medium-textured soils, such as a silt loam, have moderate K values (about 0.25 to 0.45) because they are moderately susceptible to particle detachment and they produce runoff at moderate rates. Soils having a high silt content are especially susceptible to erosion and have high K values, which can exceed 0.45 and can be as large as 0.65. Silt-size particles are easily detached and tend to crust, producing high rates and large volumes of runoff. Use Site-specific data must be submitted.		
8	Site-specific K factor guidance		
9		K Factor Value	0
10	C) LS Factor (weighted average, by area, for all slopes)		
11	The effect of topography on erosion is accounted for by the LS factor, which combines the effects of a hillslope-length factor, L, and a hillslope-gradient factor, S. Generally speaking, as hillslope length and/or hillslope gradient increase, soil loss increases. As hillslope length increases, total soil loss and soil loss per unit area increase due to the progressive accumulation of runoff in the downslope direction. As the hillslope gradient increases, the velocity and erosivity of runoff increases. Use the LS table located in separate tab of this spreadsheet to determine LS factors. Estimate the weighted LS for the site prior to construction.		
12	LS Table		
13		LS Factor Value	0
14			
15	Watershed Erosion Estimate (=RxKxLS) in tons/acre		0
16	Site Sediment Risk Factor		Low
17	Low Sediment Risk: < 15 tons/acre		
18	Medium Sediment Risk: >=15 and <75 tons/acre		
19	High Sediment Risk: >= 75 tons/acre		
20			
21			
22			
23	GIS Map Method:		
24	1. The R factor for the project is calculated using the online calculator at:		
25	http://cfpub.epa.gov/npdes/stormwater/LEW/lewCalculator.cfm		
26			
27	2. The K and LS factors may be obtained by accessing the GIS maps located on the State Water Board FTP website at:		
28	ftp://swrcb2a.waterboards.ca.gov/pub/swrcb/dwq/cgp/Risk/		
29			

Receiving Water (RW) Risk Factor Worksheet	Entry	Score
A. Watershed Characteristics	yes/no	
A.1. Does the disturbed area discharge (either directly or indirectly) to a 303(d)-listed waterbody impaired by sediment (For help with impaired waterbodies please visit the link below) or has a USEPA approved TMDL implementation plan for sediment ? http://www.waterboards.ca.gov/water_issues/programs/tmdl/integrated2010.shtml	no	Low
OR		
A.2. Does the disturbed area discharge to a waterbody with designated beneficial uses of SPAWN & COLD & MIGRATORY? (For help please review the appropriate Regional Board Basin Plan)		
http://www.waterboards.ca.gov/waterboards_map.shtml		
Region 1 Basin Plan Region 2 Basin Plan Region 3 Basin Plan Region 4 Basin Plan Region 5 Basin Plan Region 6 Basin Plan Region 7 Basin Plan Region 8 Basin Plan Region 9 Basin Plan		

Combined Risk Level Matrix

		<u>Sediment Risk</u>		
		Low	Medium	High
<u>Receiving Water Risk</u>	Low	Level 1	Level 2	
	High	Level 2		Level 3

Project Sediment Risk: **Low**

Project RW Risk: **Low**

Project Combined Risk: **Level 1**

Soil Erodibility Factor (K)

The K factor can be determined by using the nomograph method, which requires that a particle size analysis (ASTM D-422) be done to determine the percentages of sand, very fine sand, silt and clay. Use the figure below to determine appropriate K value.

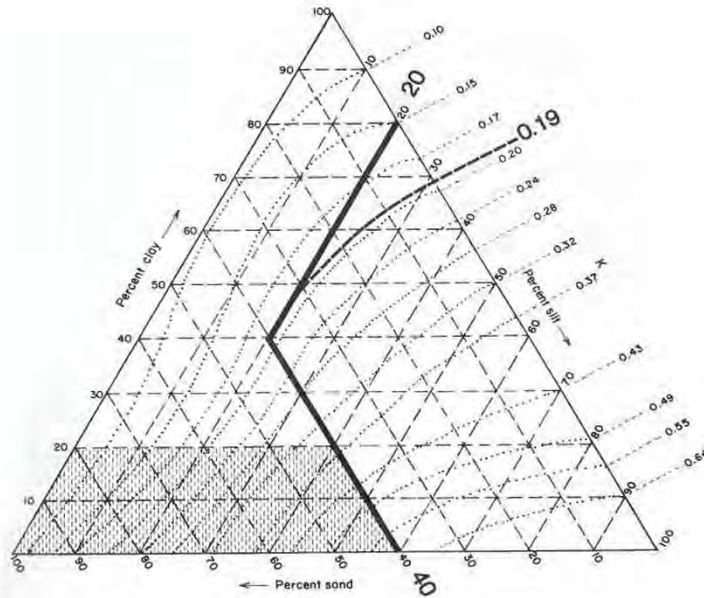

Erickson triangular nomograph used to estimate soil erodibility (K) factor.

The figure above is the USDA nomograph used to determine the K factor for a soil, based on its texture (% silt plus very fine sand, % sand, % organic matter, soil structure, and permeability). *Nomograph from Erickson 1977 as referenced in Goldman et. al., 1986.*

		Average Watershed Slope (%)																	
Sheet Flow Length (ft)																			
	0.2	0.5	1.0	2.0	3.0	4.0	5.0	6.0	8.0	10.0	12.0	14.0	16.0	20.0	25.0	30.0	40.0	50.0	60.0
<3	0.05	0.07	0.09	0.13	0.17	0.20	0.23	0.26	0.32	0.35	0.36	0.38	0.39	0.41	0.45	0.48	0.53	0.58	0.63
6	0.05	0.07	0.09	0.13	0.17	0.20	0.23	0.26	0.32	0.37	0.41	0.45	0.49	0.56	0.64	0.72	0.85	0.97	1.07
9	0.05	0.07	0.09	0.13	0.17	0.20	0.23	0.26	0.32	0.38	0.45	0.51	0.56	0.67	0.80	0.91	1.13	1.31	1.47
12	0.05	0.07	0.09	0.13	0.17	0.20	0.23	0.26	0.32	0.39	0.47	0.55	0.62	0.76	0.93	1.08	1.37	1.62	1.84
15	0.05	0.07	0.09	0.13	0.17	0.20	0.23	0.26	0.32	0.40	0.49	0.58	0.67	0.84	1.04	1.24	1.59	1.91	2.19
25	0.05	0.07	0.10	0.16	0.21	0.26	0.31	0.36	0.45	0.57	0.71	0.85	0.98	1.24	1.56	1.86	2.41	2.91	3.36
50	0.05	0.08	0.13	0.21	0.30	0.38	0.46	0.54	0.70	0.91	1.15	1.40	1.64	2.10	2.67	3.22	4.24	5.16	5.97
75	0.05	0.08	0.14	0.25	0.36	0.47	0.58	0.69	0.91	1.20	1.54	1.87	2.21	2.86	3.67	4.44	5.89	7.20	8.37
100	0.05	0.09	0.15	0.28	0.41	0.55	0.68	0.82	1.10	1.46	1.88	2.31	2.73	3.57	4.59	5.58	7.44	9.13	10.63
150	0.05	0.09	0.17	0.33	0.50	0.68	0.86	1.05	1.43	1.92	2.51	3.09	3.68	4.85	6.30	7.70	10.35	12.75	14.89
200	0.06	0.10	0.18	0.37	0.57	0.79	1.02	1.25	1.72	2.34	3.07	3.81	4.56	6.04	7.88	9.67	13.07	16.16	18.92
250	0.06	0.10	0.19	0.40	0.64	0.89	1.16	1.43	1.99	2.72	3.60	4.48	5.37	7.16	9.38	11.55	15.67	19.42	22.78
300	0.06	0.10	0.20	0.43	0.69	0.98	1.28	1.60	2.24	3.09	4.09	5.11	6.15	8.23	10.81	13.35	18.17	22.57	26.51
400	0.06	0.11	0.22	0.48	0.80	1.14	1.51	1.90	2.70	3.75	5.01	6.30	7.60	10.24	13.53	16.77	22.95	28.60	33.67
600	0.06	0.12	0.24	0.56	0.96	1.42	1.91	2.43	3.52	4.95	6.67	8.45	10.26	13.94	18.57	23.14	31.89	39.95	47.18
800	0.06	0.12	0.26	0.63	1.10	1.65	2.25	2.89	4.24	6.03	8.17	10.40	12.69	17.35	23.24	29.07	40.29	50.63	59.93
1000	0.06	0.13	0.27	0.69	1.23	1.86	2.55	3.30	4.91	7.02	9.57	12.23	14.96	20.57	27.66	34.71	48.29	60.84	72.15

LS Factors for Construction Sites. *Table from Renard et. al., 1997.*

APPENDIX 2: Post-Construction Water Balance Performance Standard Spreadsheet

The discharger shall submit with their Notice of Intent (NOI) the following information to demonstrate compliance with the New and Re-Development Water Balance Performance Standard.

Map Instructions

The discharger must submit a small-scale topographic map of the site to show the existing contour elevations, pre- and post-construction drainage divides, and the total length of stream in each watershed area. Recommended scales include 1 in. = 20 ft., 1 in. = 30 ft., 1 in. = 40 ft., or 1 in = 50 ft. The suggested contour interval is usually 1 to 5 feet, depending upon the slope of the terrain. The contour interval may be increased on steep slopes. Other contour intervals and scales may be appropriate given the magnitude of land disturbance.

Spreadsheet Instructions

The intent of the spreadsheet is to help dischargers calculate the project-related increase in runoff volume and select impervious area and runoff reduction credits to reduce the project-related increase in runoff volume to pre-project levels.

The discharger has the option of using the spreadsheet (**Appendix 2.1**) or a more sophisticated, watershed process-based model (e.g. Storm Water Management Model, Hydrological Simulation Program Fortran) to determine the project-related increase in runoff volume.

In Appendix 4.1, you must complete the worksheet for each land use/soil type combination for each project sub-watershed.

Steps 1 through 9 pertain specifically to the Runoff Volume Calculator:

Step 1: Enter the county where the project is located in cell H3.

Step 2: Enter the soil type in cell H6.

Step 3: Enter the existing pervious (dominant) land use type in cell H7.

Step 4: Enter the proposed pervious (dominant) land use type in cell H8.

Step 5: Enter the total project site area in cell H11 or J11.

Step 6: Enter the sub-watershed area in cell H12 or J12.

- Step 7: Enter the existing rooftop area in cell H17 or J17, the existing non-rooftop impervious area in cell H18 or J18, the proposed rooftop area in cell H19 or J19, and the proposed non-rooftop impervious area in cell H20 or J20
- Step 8: Work through each of the impervious area reduction credits and claim credits where applicable. Volume that cannot be addressed using non-structural practices must be captured in structural practices and approved by the Regional Water Board.
- Step 9: Work through each of the impervious volume reduction credits and claim credits where applicable. Volume that cannot be addressed using non-structural practices must be captured in structural practices and approved by the Regional Water Board.

Non-structural Practices Available for Crediting

- ***Porous Pavement***
- ***Tree Planting***
- ***Downspout Disconnection***
- ***Impervious Area Disconnection***
- ***Green Roof***
- ***Stream Buffer***
- ***Vegetated Swales***
- ***Rain Barrels and Cisterns***
- ***Landscaping Soil Quality***

Post-Construction Water Balance Calculator

1	Post-Construction Water Balance Calculator													
2														
3	User may make changes from any cell that is orange or brown in color (similar to the cells to the immediate right). Cells in green are calculated for you.		(Step 1a) If you know the 85th percentile storm event for your location enter it in the box below		(Step 1b) If you can not answer 1a then select the county where the project is located (click on the cell to the right for drop-down): This will determine the average 85th percentile 24 hr. storm event for your site, which will appear under precipitation to left.		SACRAMENTO							
4			(Step 1c) If you would like a more precise value select the location closest to your site. If you do not recognize any of these locations, leave this drop-down menu at location. The average value for the County will be used.		SACRAMENTO FAA ARPT									
5	Project Information				Runoff Calculations									
6	Project Name:		Optional		(Step 2) Indicate the Soil Type (dropdown menu to right):		Group C Soils		Low infiltration. Sandy clay loam. Infiltration rate 0.05 to 0.15 inch/hr when wet.					
7	Waste Discharge Identification (WDID):		Optional		(Step 3) Indicate the existing dominant non-built land Use Type (dropdown menu to right):		Wood & Grass: <50% ground cover							
8	Date:		Optional		(Step 4) Indicate the proposed dominant non-built land Use Type (dropdown menu to right):		Lawn, Grass, or Pasture covering more than 75% of the open space							
9	Sub Drainage Area Name (from map):		Optional				Complete Either							
10	Runoff Curve Numbers						Sq Ft		Acres					
11	Existing Pervious Runoff Curve Number		82		(Step 5) Total Project Site Area:		5.00		5.00					
12	Proposed Development Pervious Runoff Curve Number		74		(Step 6) Sub-watershed Area:		5.00		5.00					
13	Design Storm				Percent of total project :		100%							
14	Based on the County you indicated above, we have included the 85 percentile average 24 hr event - P85 (in)^ for your area.		0.62		in									
15	The Amount of rainfall needed for runoff to occur (Existing runoff curve number -P from existing RCN (in)^)		0.44		In		(Step 7) Sub-watershed Conditions		Complete Either					
16	P used for calculations (in) (the greater of the above two criteria)		0.62		In		Sub-watershed Area (acres)		Calculated Acres					
17	^Available at www.cabmphandbooks.com				Existing Rooftop Impervious Coverage		0		0.00					
18							Existing Non-Rooftop Impervious Coverage		0		0.00			
19							Proposed Rooftop Impervious Coverage		0		0.00			
20							Proposed Non-Rooftop Impervious Coverage		0		0.00			
21							Credits		Acres		Square Feet			
22							Porous Pavement		0.00		0			
23					Tree Planting		0.00		0					
24														
25	Pre-Project Runoff Volume (cu ft)		247		Cu.Ft.		Downspout Disconnection		0					
26	Project-Related Runoff Volume Increase w/o credits (cu ft)		0		Cu.Ft.		Impervious Area Disconnection		0					
27							Green Roof		0					
28							Stream Buffer		0					
29							Vegetated Swales		0					
30	Project-Related Volume Increase with Credits (cu ft)		0		Cu.Ft.		Subtotal		0.00					
31							Subtotal		0 Cu. Ft.					
32	You have achieved your minimum requirements						(Step 9) Impervious Volume Reduction Credits		Volume (cubic feet)					
33									Rain Barrels/Cisterns		0 Cu. Ft.			
34									Soil Quality		0 Cu. Ft.			
35														
36											Subtotal		0 Cu. Ft.	
37											Total		0 Cu. Ft.	
38														
39														

Porous Pavement Credit Worksheet

Please fill out a porous pavement credit worksheet for each project sub-watershed.

For the PROPOSED Development:

Proposed Porous Pavement	Runoff Reduction*	Fill in either Acres or SqFt		Equivalent Acres
		In SqFt.	In Acres	
Area of Brick without Grout on <u>less than 12 inches</u> of base with at least 20% void space over soil	0.45			0.00
Area of Brick without Grout on <u>more than 12 inches</u> of base with at least 20% void space over soil	0.90			0.00
Area of Cobbles <u>less than 12 inches</u> deep and over soil	0.30			0.00
Area of Cobbles <u>less than 12 inches</u> deep and over soil	0.60			0.00
Area of Reinforced Grass Pavement on <u>less than 12 inches</u> of base with at least 20% void space over soil	0.45			0.00
Area of Reinforced Grass Pavement on <u>at least 12 inches</u> of base with at least 20% void space over soil	0.90			0.00
Area of Porous Gravel Pavement on <u>less than 12 inches</u> of base with at least 20% void space over soil	0.38			0.00
Area of Porous Gravel Pavement on <u>at least 12 inches</u> of base with at least 20% void space over soil	0.75			0.00
Area of Poured Porous Concrete or Asphalt Pavement with <u>less than 4 inches</u> of gravel base (washed stone)	0.40			0.00
Area of Poured Porous Concrete or Asphalt Pavement with <u>4 to 8 inches</u> of gravel base (washed stone)	0.60			0.00
Area of Poured Porous Concrete or Asphalt Pavement with <u>8 to 12 inches</u> of gravel base (washed stone)	0.80			0.00
Area of Poured Porous Concrete or Asphalt Pavement with <u>12 or more</u> inches of gravel base (washed stone)	1.00			0.00

*=1-Rv**

[Return to Calculator](#)

**Using Site Design Techniques to meet Development Standards for Stormwater Quality (BASMAA 2003)
 **NCDENR Stormwater BMP Manual (2007)

Tree Planting Credit Worksheet

Please fill out a tree canopy credit worksheet for each project sub-watershed.

Tree Canopy Credit Criteria	Number of Trees Planted	Credit (acres)
Number of proposed evergreen trees to be planted (credit = number of trees x 0.005)*	0	0.00
Number of proposed deciduous trees to be planted (credit = number of trees x 0.0025)*		0.00
	Square feet Under Canopy	
Square feet under an existing tree canopy, that will remain on the property, with an average diameter at 4.5 ft above grade (i.e., diameter at breast height or DBH) is LESS than 12 in diameter.		0.00
Square feet under an existing tree canopy that will remain on the property, with an average diameter at 4.5 ft above grade (i.e., diameter at breast height or DBH) is 12 in diameter or GREATER.		0.00
Please describe below how the project will ensure that these trees will be maintained.		

0

[Return to Calculator](#)

* credit amount based on credits from Stormwater Quality Design Manual for the Sacramento and South Placer Regions

Downspout Disconnection Credit Worksheet

Please fill out a downspout disconnection credit worksheet for each project subwatershed. If you answer yes to all questions, all rooftop area draining to each downspout will be subtracted from your proposed rooftop impervious coverage.

Downspout Disconnection Credit Criteria					
Do downspouts and any extensions extend at least six feet from a basement and two feet from a crawl space or concrete slab?				<input type="radio"/> Yes	<input checked="" type="radio"/> No
Is the area of rooftop connecting to each disconnected downspout 600 square feet or less?				<input type="radio"/> Yes	<input checked="" type="radio"/> No
Is the roof runoff from the design storm event fully contained in a raised bed or planter box or does it drain as sheet flow to a landscaped area large enough to contain the roof runoff from the design storm event?				<input type="radio"/> Yes	<input checked="" type="radio"/> No
The Stream Buffer and/or Vegetated Swale credits will not be taken in this sub-watershed area?				<input type="radio"/> Yes	<input checked="" type="radio"/> No
Percentage of existing	0.00	Acres	of rooftop surface has disconnected downspouts		
Percentage of the proposed	0.00	Acres	of rooftop surface has disconnected downspouts		
				50	
				Return to Calculator	

Impervious Area Disconnection Credit Worksheet

Please fill out an impervious area disconnection credit worksheet for each project sub-watershed. If you answer yes to all questions, all non-rooftop impervious surface area will be subtracted from your proposed non-rooftop impervious coverage.

Non-Rooftop Disconnection Credit Criteria	Response
Is the maximum contributing impervious flow path length less than 75 feet or, if equal or greater than 75 feet, is a storage device (e.g. French drain, bioretention area, gravel trench) implemented to achieve the required disconnection length?	<input checked="" type="radio"/> Yes <input type="radio"/> No
Is the impervious area to any one discharge location less than 5,000 square feet?	<input checked="" type="radio"/> Yes <input type="radio"/> No
The Stream Buffer credit will not be taken in this sub-watershed area?	<input checked="" type="radio"/> Yes <input type="radio"/> No

Percentage of existing	0.00	Acres non-rooftop surface area disconnected	
Percentage of the proposed	0.00	Acres non-rooftop surface area disconnected	70

[Return to Calculator](#)

Green Roof Credit Worksheet

Please fill out a greenroof credit worksheet for each project sub-watershed. If you answer yes to all questions, 70% of the greenroof area will be subtracted from your proposed rooftop impervious coverage.

Green Roof Credit Criteria		Response
Is the roof slope less than 15% or does it have a grid to hold the substrate in place until it forms a thick vegetation mat?		<input checked="" type="radio"/> Yes <input type="radio"/> No
Has a professional engineer assessed the necessary load reserves and designed a roof structure to meet state and local codes?		<input checked="" type="radio"/> Yes <input type="radio"/> No
Is the irrigation needed for plant establishment and/or to sustain the green roof during extended dry periods, is the source from stored, recycled, reclaimed, or reused water?		<input checked="" type="radio"/> Yes <input type="radio"/> No
Percentage of existing	0.0 0 Acres rooftop surface area in greenroof	
Percentage of the proposed	0.0 0 Acres rooftop surface area in greenroof	
		Return to Calculator

Stream Buffer Credit Worksheet

Please fill out a stream buffer credit worksheet for each project sub-watershed. If you answer yes to all questions, you may subtract all impervious surface draining to each stream buffer that has not been addressed using the Downspout and/or Impervious Area Disconnection credits.

Stream Buffer Credit Criteria				Response
Does runoff enter the floodprone width* or within 500 feet (whichever is larger) of a stream channel as sheet flow**?				<input type="radio"/> Yes <input checked="" type="radio"/> No
Is the contributing overland slope 5% or less, or if greater than 5%, is a level spreader used?				<input type="radio"/> Yes <input checked="" type="radio"/> No
Is the buffer area protected from vehicle or other traffic barriers to reduce compaction?				<input type="radio"/> Yes <input checked="" type="radio"/> No
Will the stream buffer be maintained in an ungraded and uncompacted condition and will the vegetation be maintained in a natural condition?				<input type="radio"/> Yes <input checked="" type="radio"/> No
Percentage of existing	0.00	Acres	impervious surface area draining into a stream buffer:	
Percentage of the proposed	0.00	Acres	impervious surface area that will drain into a stream buffer:	
Please describe below how the project will ensure that the buffer areas will remain in ungraded and uncompacted condition and that the vegetation will be maintained in a natural condition.				

[Return to Calculator](#)

* floodprone width is the width at twice the bankfull depth.

** the maximum contributing length shall be 75 feet for impervious area

Vegetated Swale Credit Worksheet

Please fill out a vegetated swale worksheet for each project subwatershed. If you answer yes to all questions, you may subtract all impervious surface draining to each stream buffer that has not been addressed using the Downspout Disconnection credit.

Vegetated Swale Credit Criteria

Have all vegetated swales been designed in accordance with Treatment Control BMP 30 (TC-30 - Vegetated Swale) from the California Stormwater BMP Handbook, New Development and Redevelopment (available at www.cabmphandbooks.com)?

<input type="radio"/> Yes	<input checked="" type="radio"/> No
---------------------------	-------------------------------------

Is the maximum flow velocity for runoff from the design storm event less than or equal to 1.0 foot per second?

<input type="radio"/> Yes	<input checked="" type="radio"/> No
---------------------------	-------------------------------------

Percentage of existing	0.00	Acres of impervious area draining to a vegetated swale	
Percentage of the proposed	0.00	Acres of impervious area draining to a vegetated swale	

[Return to Calculator](#)

Rain Barrel/Cistern Credit Worksheet

Please fill out a rain barrel/cistern worksheet for each project sub-watershed.

Rain Barrel/Cistern Credit Criteria	Response
Total number of rain barrel(s)/cisterns	
Average capacity of rain barrel(s)/cistern(s) (in gallons)	
Total capacity rain barrel(s)/cistern(s) (in cu ft) ¹	0

¹ accounts for 10% loss

[Return to Calculator](#)

Please fill out a soil quality worksheet for each project sub-watershed.

	Response
Will the landscaped area be lined with an impervious membrane?	
Will the soils used for landscaping meet the ideal bulk densities listed in Table 1 below? ¹	<input type="radio"/> Yes <input checked="" type="radio"/> No
If you answered yes to the question above, and you know the area-weighted bulk density within the top 12 inches for soils used for landscaping (in g/cm ³)*, fill in the cell to the right and skip to cell G11. If not select from the drop-down menu in G10.	1.3
If you answered yes to the question above, but you do not know the exact bulk density, which of the soil types in the drop down menu to the right best describes the top 12 inches for soils used for landscaping (in g/cm ³).	Sandy loams, loams
What is the average depth of your landscaped soil media meeting the above criteria (inches)?	12
What is the total area of the landscaped areas meeting the above criteria (in acres)?	2.97

[Return to Calculator](#)

Table 1

Sands, loamy sands	<1.6
Sandy loams, loams	<1.4
Sandy clay loams, loams, clay loams	<1.4
Silts, silt loams	<1.3
Silt loams, silty clay loams	<1.1
Sandy clays, silty clays, some clay loams (35-45% clay)	<1.1
Clays (>45% clay)	<1.1

Porosity (%) 50.94%

Mineral grains in many soils are mainly quartz and feldspar, so 2.65 a good average for particle density. To determine percent porosity, use the formula: Porosity (%) = (1-Bulk Density/2.65) X 100

¹ USDA NRCS. "Soil Quality Urban Technical Note No.2-Urban Soil Compaction". March 2000.

http://soils.usda.gov/sqi/management/files/sq_utn_2.pdf

* To determine how to calculate density see:

<http://www.globe.gov/tctg/bulkden.pdf?sectionID=94>

APPENDIX 3 Bioassessment Monitoring Guidelines

Bioassessment monitoring is required for projects that meet all of the following criteria:

1. The project is rated Risk Level 3 or LUP Type 3
2. The project directly discharges runoff to a freshwater wadeable stream (or streams) that is either: (a) listed by the State Water Board or USEPA as impaired due to sediment, and/or (b) tributary to any downstream water body that is listed for sediment; and/or have the beneficial use SPAWN & COLD & MIGRATORY
3. Total project-related ground disturbance exceeds 30 acres.

For all such projects, the discharger shall conduct bioassessment monitoring, as described in this section, to assess the effect of the project on the biological integrity of receiving waters.

Bioassessment shall include:

1. The collection and reporting of specified instream biological data
2. The collection and reporting of specified instream physical habitat data

Bioassessment Exception

If a site qualifies for bioassessment, but construction commences out of an index period for the site location, the discharger shall:

1. Receive Regional Water Board approval for the sampling exception
2. Make a check payable to: Cal State Chico Foundation (SWAMP Bank Account) or San Jose State Foundation (SWAMP Bank Account) and include the WDID# on the check for the amount calculated for the exempted project.
3. Send a copy of the check to the Regional Water Board office for the site's region
4. Invest **7,500.00 X The number of samples required** into the SWAMP program as compensation (upon Regional Water Board approval).
5. Conduct bioassessment monitoring, as described in Appendix 4
6. Include the collection and reporting of specified instream biological data and physical habitat
7. Use the bioassessment sample collection and Quality Assurance & Quality Control (QA/QC) protocols developed by the State of California's Surface Water Ambient Monitoring Program (SWAMP)

Site Locations and Frequency

Macroinvertebrate samples shall be collected both before ground disturbance is initiated and after the project is completed. The "after" sample(s) shall be collected after at least one winter season resulting in surface runoff has transpired after project-related ground disturbance has ceased. "Before" and "after" samples shall be collected both upstream and downstream of the project's

discharge. Upstream samples should be taken immediately before the sites outfall and downstream samples should be taken immediately after the outfall (when safe to collect the samples). Samples should be collected for each freshwater wadeable stream that is listed as impaired due to sediment, or tributary to a water body that is listed for sediment. Habitat assessment data shall be collected concurrently with all required macroinvertebrate samples.

Index Period (Timing of Sample Collection)

Macroinvertebrate sampling shall be conducted during the time of year (i.e., the “index period”) most appropriate for bioassessment sampling, depending on ecoregion. This map is posted on the State Water Board’s Website: http://www.waterboards.ca.gov/water_issues/programs/stormwater/construction.shtml

Field Methods for Macroinvertebrate Collections

In collecting macroinvertebrate samples, the discharger shall use the “Reachwide Benthos (Multi-habitat) Procedure” specified in *Standard Operating Procedures for Collecting Benthic Macroinvertebrate Samples and Associated Physical and Chemical Data for Ambient Bioassessments in California* (Ode 2007).¹

Physical - Habitat Assessment Methods

The discharger shall conduct, concurrently with all required macroinvertebrate collections, the “Full” suite of physical habitat characterization measurements as specified in *Standard Operating Procedures for Collecting Benthic Macroinvertebrate Samples and Associated Physical and Chemical Data for Ambient Bioassessments in California* (Ode 2007), and as summarized in the Surface Water Ambient Monitoring Program’s *Stream Habitat Characterization Form — Full Version*.

Laboratory Methods

Macroinvertebrates shall be identified and classified according to the Standard Taxonomic Effort (STE) Level I of the Southwestern Association of Freshwater Invertebrate Taxonomists (SAFIT),² and using a fixed-count of 600 organisms per sample.

Quality Assurance

The discharger or its consultant(s) shall have and follow a quality assurance (QA) plan that covers the required bioassessment monitoring. The QA plan shall include, or be supplemented to include, a specific requirement for external QA checks (i.e., verification of taxonomic identifications and correction of data where

¹ This document is available on the Internet at: http://www.swrcb.ca.gov/swamp/docs/phab_sopr6.pdf.
http://swamp.mpsl.mml.calstate.edu/wp-content/uploads/2009/04/swamp_sop_bioassessment_collection_020107.pdf.

² The current SAFIT STEs (28 November 2006) list requirements for both the Level I and Level II taxonomic effort, and are located at: http://www.swrcb.ca.gov/swamp/docs/safit/ste_list.pdf
http://www.safit.org/Docs/ste_list.pdf. When new editions are published by SAFIT, they will supersede all previous editions. All editions will be posted at the State Water Board’s SWAMP website.

errors are identified). External QA checks shall be performed on one of the discharger's macroinvertebrate samples collected per calendar year, or ten percent of the samples per year (whichever is greater). QA samples shall be randomly selected. The external QA checks shall be paid for by the discharger, and performed by the California Department of Fish and Game's Aquatic Bioassessment Laboratory. An alternate laboratory with equivalent or better expertise and performance may be used if approved in writing by State Water Board staff.

Sample Preservation and Archiving

The original sample material shall be stored in 70 percent ethanol and retained by the discharger until: 1) all QA analyses specified herein and in the relevant QA plan are completed; and 2) any data corrections and/or re-analyses recommended by the external QA laboratory have been implemented. The remaining subsampled material shall be stored in 70 percent ethanol and retained until completeness checks have been performed according to the relevant QA plan. The identified organisms shall be stored in 70 percent ethanol, in separate glass vials for each final ID taxon. (For example, a sample with 45 identified taxa would be archived in a minimum of 45 vials, each containing all individuals of the identified taxon.) Each of the vials containing identified organisms shall be labeled with taxonomic information (i.e., taxon name, organism count) and collection information (i.e., site name/site code, waterbody name, date collected, method of collection). The identified organisms shall be archived (i.e., retained) by the discharger for a period of not less than three years from the date that all QA steps are completed, and shall be checked at least once per year and "topped off" with ethanol to prevent desiccation. The identified organisms shall be relinquished to the State Water Board upon request by any State Water Board staff.

Data Submittal

The macroinvertebrate results (i.e., taxonomic identifications consistent with the specified SAFIT STEs, and number of organisms within each taxa) shall be submitted to the State Water Board in electronic format. The State Water Board's Surface Water Ambient Monitoring Program (SWAMP) is currently developing standardized formats for reporting bioassessment data. All bioassessment data collected after those formats become available shall be submitted using the SWAMP formats. Until those formats are available, the biological data shall be submitted in MS-Excel (or equivalent) format.³

The physical/habitat data shall be reported using the standard format titled *SWAMP Stream Habitat Characterization Form — Full Version*.⁴

³ Any version of Excel, 2000 or later, may be used.

⁴ Available at:

http://www.waterboards.ca.gov/water_issues/programs/swamp/docs/reports/fieldforms_fullversion052908.pdf

Invasive Species Prevention

In conducting the required bioassessment monitoring, the discharger and its consultants shall take precautions to prevent the introduction or spread of aquatic invasive species. At minimum, the discharger and its consultants shall follow the recommendations of the California Department of Fish and Game to minimize the introduction or spread of the New Zealand mudsnail.⁵

⁵ Instructions for controlling the spread of NZ mudsnails, including decontamination methods, can be found at: <http://www.dfg.ca.gov/invasives/mudsnail/>
More information on AIS More information on AIS
http://www.waterboards.ca.gov/water_issues/programs/swamp/ais/

Appendix 4 Non Sediment TMDLs

Region 1 Lost River-DIN and CBOD

Region 1 Source: Cal Trans Construction TMDL Completion Date: 12 30 2008 TMDL Type: River, Lake Watershed Area= 2996 mi ²	Pollutant Stressors/WLA	
	Dissolved inorganic nitrogen (DIN) (metric tons/yr)	Carbonaceous biochemical oxygen demand (CBOD) (metric tons/yr)
Lost River from the Oregon border to Tule Lake	.1	.2
Tule Lake Refuge	.1	.2
Lower Klamath Refuge	.1	.2

Region 2 San Francisco Bay-Mercury

Region 2 Source:Non-Urban Stormwater Runoff TMDL Type: Bay	Name	Pollutant Stressor/WLA	TMDL Completion Date
	San Francisco Bay	Mercury 25 kg/year	08 09 2006

Region 4 Ballona Creek-Metals and Selenium

Region 4 Source: NPDES General Construction TMDL Completion Date: 12 22 2005 TMDL Type: Creek	Pollutant Stressors/WLA							
	Copper (Cu)		Lead (Pb)		Selenium (Se)		Zinc (Zn)	
	g/day	g/day/acre	g/day	g/day/acre	g/day	g/day/acre	g/day	g/day/acre
Ballona Creek	4.94E-07 x Daily storm volume (L)	2.20E-10 x Daily storm volume (L)	1.62E-06 x Daily storm volume (L)	7.20E-10 x Daily storm volume (L)	1.37E-07 x Daily storm volume (L)	6.10E-11 x Daily storm volume (L)	3.27E-06 x Daily storm volume (L)	1.45E-09 x Daily storm volume (L)

General Construction Storm Water Permits:

Waste load allocations will be incorporated into the State Board general permit upon renewal or into a watershed-specific general permit developed by the Regional Board.

- Dry-weather Implementation Non-storm water flows authorized by the General Permit for Storm Water Discharges Associated with Construction Activity (Water Quality Order No. 99-08 DWQ), or any successor order, are exempt from the dry-weather waste load allocation equal to zero as long as they comply with the provisions of sections C.3 and A.9 of the Order No. 99-08 DWQ, which state that these authorized non-storm discharges shall be:
 - (1) infeasible to eliminate
 - (2) comply with BMPs as described in the Storm Water Pollution Prevention Plan prepared by the permittee, and
 - (3) not cause or contribute to a violation of water quality standards, or comparable provisions in any successor order.
 Unauthorized non-storm water flows are already prohibited by Order No. 99-08 DWQ.
- Wet-weather Implementation Within seven years of the effective date of the TMDL, the construction industry will submit the results of BMP effectiveness studies to determine BMPs that will achieve compliance with the final waste load allocations assigned to construction storm water permittees.
- Regional Board staff will bring the recommended BMPs before the Regional Board for consideration within eight years of the effective date of the TMDL.
- General construction storm water permittees will be considered in compliance with final waste load allocations if they implement these Regional Board approved BMPs. All permittees must implement the approved BMPs within nine years of the effective date of the TMDL. If no effectiveness studies are conducted and no BMPs are approved by the Regional Board within eight years of the effective date of the TMDL, each general construction storm water permit holder will be subject to site-specific BMPs and monitoring requirements to demonstrate compliance with final waste load allocations.

Region 4 Calleaguas Creek-OC Pesticides, PCBs, and Siltation

Interim Requirements

Region 4 Calleaguas Creek Source: Minor NPDES point sources/WDRs TMDL Completion Date: 3 14 2006 TMDL Type:Creek	Pollutant Stressor	WLA Daily Max (µg/L)	WLA Monthly Ave (µg/L)
	Chlordane	1.2	0.59
	4,4-DDD	1.7	0.84
	4,4-DDE	1.2	0.59
	4,4-DDT	1.2	0.59
	Dieldrin	0.28	0.14
	PCB's	0.34	0.17
	Toxaphene	0.33	0.16

Final WLA (ng/g)							
Region 4 Calleguas Creek Source: Stormwater Permittees TMDL Completion Date: 3 14 2006 TMDL Type:Creek	Chlordane	4,4-DDD	4,4-DDE	4,4-DDT	Dieldrin	PCB's	Toxaphene
Mugu Lagoon*	3.3	2.0	2.2	0.3	4.3	180.0	360.0
Callegaus Creek	3.3	2.0	1.4	0.3	0.2	120.0	0.6
Revolon Slough (SW)*	0.9	2.0	1.4	0.3	0.1	130.0	1.0
Arroyo Las posas(SW)*	3.3	2.0	1.4	0.3	0.2	120.0	0.6
Arroyo Simi	3.3	2.0	1.4	0.3	0.2	120.0	0.6
Conejo Creek	3.3	2.0	1.4	0.3	0.2	120.0	0.6
Interim Requirements (ng/g)							
Mugu Lagoon*	25.0	69.0	300.0	39.0	19.0	180.	22900.0
Callegaus Creek	17.0	66.0	470.0	110.0	3.0	3800.0	260.0
Revolon Slough (SW)*	48.0	400.0	1600.0	690.0	5.7	7600.0	790.0
Arroyo Las posas(SW)*	3.3	290.0	950.0	670.0	1.1	25700.0	230.0
Arroyo Simi	3.3	14.0	170.0	25.0	1.1	25700.0	230.0
Conejo Creek	3.4	5.3	20.0	2.0	3.0	3800.0	260.0

*(SW)=Subwatershed

*Mugu Lagoon includes Duck pond/Agricultural Drain/Mugu/Oxnard Drain #2

Compliance with sediment based WLAs is measured as an instream annual average at the base of each subwatershed where the discharges are located.

Region 4 Calleguas Creek-Salts

Final Dry Weather Pollutant WLA (mg/L)					
Region 4 Calleguas Creek Source Permitted Stormwater Dischargers TMDL Completion Date: 12 2 2008 TMDL Type:Creek	Critical Condition Flow Rate (mgd)	Chloride (lb/day)	TDS (lb/day)	Sulfate (lb/day)	Boron (lb/day)
Simi	1.39	1738.0	9849.0	2897.0	12.0
Las Posas	0.13	157.0	887.0	261.0	N/A
Conejo	1.26	1576.0	8931.0	2627.0	N/A

Camarillo	0.06	72.0	406.0	119.0	N/A
Pleasant Valley (Calleguas)	0.12	150.0	850.0	250.0	N/A
Pleasant Valley (Revolon)	0.25	314.0	1778.0	523.0	2.0
Dry Weather Interim Pollutant WLA (mg/L)					
	Chloride (mg/L)	TDS (mg/L)	Sulfate (mg/L)	Boron (mg/L)	
Simi	230.0	1720.0	1289.0	1.3	
Las Posas	230.0	1720.0	1289.0	1.3	
Conejo	230.0	1720.0	1289.0	1.3	
Camarillo	230.0	1720.0	1289.0	1.3	
Pleasant Valley (Calleguas)	230.0	1720.0	1289.0	1.3	
Pleasant Valley (Revolon)	230.0	1720.0	1289.0	1.3	

- General Construction permittees are assigned a dry weather wasteload allocation equal to the average dry weather critical condition flow rate multiplied by the numeric target for each constituent. Waste load allocations apply in the receiving water at the base of each subwatershed. Dry weather allocations apply when instream flow rates are below the 86th percentile flow and there has been no measurable precipitation in the previous 24 hours.
- Because wet weather flows transport a large mass of salts at low concentrations, these dischargers meet water quality objectives during wet weather.
- Interim limits are assigned for dry weather discharges from areas covered by NPDES stormwater permits to allow time to implement appropriate actions. The interim limits are assigned as concentration based receiving water limits set to the 95th percentile of the discharger data as a monthly average limit except for chloride. The 95th percentile for chloride was 267 mg/L which is higher than the recommended criteria set forth in the Basin Plan for protection of sensitive beneficial uses including aquatic life. Therefore, the interim limit for chloride for Permitted Stormwater Dischargers is set equal to 230 mg/L to ensure protection of sensitive beneficial uses in the Calleguas Creek watershed.

Region 4 San Gabriel River and Tributaries-Metals and Selenium

Region 4 San Gabriel River and Tributaries Source: Construction Stormwater Dischargers TMDL Completion Date: 3 2007 TMDL Type: Creek	Pollutant Stressor	Wet weather Allocations	Dry Weather Allocations	% of Watershed
--	---------------------------	--------------------------------	--------------------------------	-----------------------

San Gabriel Reach 2	Lead (Pb)	0.7% * 166 µg/l * Daily Storm Vol	N/A	0.7%
San Gabriel Reach 2	Lead (Pb) Mass based	0.8 kg/d	N/A	0.7%
Coyote Creek	Copper (Cu)	0.285 kg/d	0	5.0%
Coyote Creek	Lead (Pb)	1.70 kg/d	N/A	5.0%
Coyote Creek	Zinc (Zn)	2.4 kg/d	N/A	5.0%
San Jose Creek Reach 1 and 2	Selenium	5 µg/L	5 µg/L	5.0%

Wet-weather allocations for lead in San Gabriel River Reach 2. Concentration-based allocations apply to non-stormwater NPDES discharges. Stormwater allocations are expressed as a percent of load duration curve. Mass-based values presented in table are based on a flow of 260 cfs (daily storm volume = 6.4×10^8 liters).

There are 1555 acres of water in the entire watershed, 37.4 acres of water in the Reach 1 subwatershed (2.4%), and 269 acres in the Coyote Creek subwatershed (17%).

General Construction Storm Water Permits

Waste load allocations for the general construction storm water permits may be incorporated into the State Board general permit upon renewal or into a watershed-specific general permit developed by the Regional Board. An estimate of direct atmospheric deposition is developed based on the percent area of surface water in the watershed. Approximately 0.4% of the watershed area draining to San Gabriel River Reach 2 is comprised of water and approximately 0.2% of the watershed area draining to Coyote Creek is comprised of water.

Region 4 The Harbor Beaches of Ventura County-Bacteria

The TMDL has a multi-part numeric target based on the bacteriological water quality objectives for marine water to protect the water contact recreation use. These targets are the most appropriate indicators of public health risk in recreational waters. Bacteriological objectives are set forth in Chapter 3 of the Basin Plan. The objectives are based on four bacteria indicators and include both geometric mean limits and single sample limits. The Basin Plan objectives that serve as the numeric targets for this TMDL are:

The General NPDES Construction permit is seen as a minor contributor and is given no allocation

General NPDES permits, individual NPDES permits, the Statewide Industrial Storm Water General Permit, the Statewide Construction Activity Storm Water General Permit, and WDR permittees in the Channel Islands Harbor subwatershed are assigned WLAs of zero (0) days of allowable exceedances for all three time periods and for the single sample limits and the rolling 30-day geometric mean. Any future enrollees under a general NPDES permit, individual NPDES permit, the Statewide Industrial Storm Water General Permit, the Statewide Construction Activity Storm Water General Permit, and WDR will also be subject to a WLA of zero (0) days of allowable exceedances.

Region 4 Resolution No. 03-009 Los Angeles River and Tributaries-Nutrients

Minor Point Sources

Waste loads are allocated to minor point sources enrolled under NPDES or WDR permits including but not limited to Tapia WRP, Whittier Narrows WRP, Los Angeles Zoo WRP, industrial and construction stormwater, and municipal storm water and urban runoff from municipal separate storm sewer systems (MS4s)

Region 4 Minor Point Sources for NPDES/WDR Permits TMDL Completion Date: 7 10 2003 TMDL Type: River	Pollutant Stressor/WLA				
	Total Ammonia (NH ₃)		Nitrate-nitrogen (NO ₃ -N)	Nitrite-nitrogen (NO ₂ -N)	NO ₃ -N + NO ₃ -N
	1 Hr Ave mg/l	30 Day Ave mg/l	30 Day Ave mg/l		30 Day Ave mg/l
LA River Above Los Angeles-Glendale WRP (LAG)	4.7	1.6	8.0	1.0	8.0
LA River Below LAG	8.7	2.4	8.0	1.0	8.0
Los Angeles Tributaries	10.1	2.3	8.0	1.0	8.0

Malibu Creek Attachment A to Resolution No. 2004-019R-Bacteria

12 13 2004 The WLAs for permittees under the NPDES General Stormwater Construction Permit are zero (0) days of allowable exceedances for all three time periods and for the single sample limits and the rolling 30-day geometric mean.

Region 4 Marina del Rey Harbor, Mothers' Beach and Back Basins

Attachment A to Resolution No. 2003-012-Bacteria

8 7 2003 As discussed in "Source Analysis", discharges from general NPDES permits, general industrial storm water permits and general construction storm water permits are not expected to be a significant source of bacteria. Therefore, the WLAs for these discharges are zero (0) days of allowable exceedances for all three time periods and for the single sample limits and the rolling 30-day geometric mean. Any future enrollees under a general NPDES permit, general industrial storm water permit or general construction storm water permit within the MdR Watershed will also be subject to a WLA of zero days of allowable exceedances.

Region 4 San Gabriel River and Tributaries-Metals and Selenium

Dry Weather Selenium WLA

A zero WLA is assigned to the industrial and construction stormwater permits during dry weather. Non-storm water discharges are already prohibited or restricted by existing general permits.

Region 4 General Construction Permittees TMDL Completion Date: 7 13 2006 TMDL Type: River	Total Recoverable Metals (kg/day)		
	Copper (Cu) Kg/day	Lead (Pb) Kg/day	Zinc (Zn) Kg/day
San Gabriel River Reach 2 and upstream reaches/tributaries	XXXX	Daily storm volume x 1.24 µg/L	XXXX
Coyote Creek and Tributaries	Daily storm volume x 0.7 µg/L	Daily storm volume x 4.3 µg/L	Daily storm volume x 6.2 µg/L

Each enrollee under the general construction stormwater permit receives a WLA on a per acre basis

Region 4 General Construction Permittees TMDL Completion Date: 7 13 2006 TMDL Type: River	Total Recoverable Metals (kg/day/acre)		
	Copper (Cu) Kg/acre/day	Lead (Pb) Kg/acre/day	Zinc (Zn) Kg/acre/day
San Gabriel River Reach 2 and upstream reaches/tributaries	XXXX	Daily storm volume x 0.56 µg/L	XXXX

Coyote Creek and Tributaries	Daily storm volume x 0.12 µg/L	Daily storm volume x 0.70 µg/L	Daily storm volume x 1.01 µg/L
------------------------------	-----------------------------------	-----------------------------------	-----------------------------------

For the general industrial and construction storm water permits, the daily storm volume is measured at USGS station 11085000 for discharges to Reach 2 and above and at LACDPW flow gauge station F354-R for discharges to Coyote Creek.

General construction storm water permits

WLAs will be incorporated into the State Board general permit upon renewal or into a watershed-specific general permit developed by the Regional Board.

Dry-weather implementation

Non-storm water flows authorized by the General Permit for Storm Water Discharges Associated with Construction Activity (NPDES Permit No. CAS000002), or any successor permit, are exempt from the dry-weather WLA equal to zero as long as they comply with the provisions of sections C.3.and A.9 of the Order No. 99-08 DWQ, which state that these authorized non-storm discharges shall be (1) infeasible to eliminate (2) comply with BMPs as described in the Storm Water Pollution Prevention Plan prepared by the permittee, and (3) not cause or contribute to a violation of water quality standards, or comparable provisions in any successor order. Unauthorized non-storm water flows are already prohibited by Permit No. CAS000002.

Upon permit issuance, renewal, or re-opener

Non-storm water flows not authorized by Order No. 99-08 DWQ, or any successor order, shall achieve dry-weather WLAs. WLAs shall be expressed as NPDES water quality-based effluent limitations specified in accordance with federal regulations and state policy on water quality control. Effluent limitations may be expressed as permit conditions, such as the installation, maintenance, and monitoring of Regional Board-approved BMPs.

Six years from the effective date of the TMDL

The construction industry will submit the results of wet-weather BMP effectiveness studies to the Los Angeles Regional Board for consideration. In the event that no effectiveness studies are conducted and no BMPs are approved, permittees shall be subject to site-specific BMPs and monitoring to demonstrate BMP effectiveness.

Seven years from the effective date of the TMDL

The Los Angeles Regional Board will consider results of the wet weather BMP effectiveness studies and consider approval of BMPs.

Eight years from the effective date of the TMDL

All general construction storm water permittees shall implement Regional Board-approved BMPs.

Region 8 RESOLUTION NO. R8-2007- 0024

Total Maximum Daily Loads (TMDLs) for San Diego Creek, Upper and Lower Newport Bay, Orange County, California

Region 8 NPDES Construction Permit TMDL Completion Date: 1 24 1995 TMDL Type: River, Cr, Bay	Organochlorine Compounds							
	Total DDT		Chlordane		Total PCBs		Toxaphene	
	g/day	g/yr	g/day	g/yr	g/day	g/yr	g/day	g/yr
San Diego Creek	.27	99.8	.18*	64.3*	.09*	31.5*	.004	1.5
Upper Newport Bay	.11	40.3	.06	23.4	.06	23.2	X	X
Lower Newport Bay	.04	14.9	.02	8.6	.17	60.7	X	X

*Red= Informational WLA only, not for enforcement purposes

Organochlorine Compounds TMDLs Implementation Tasks and Schedule

Regional Board staff shall develop a SWPPP Improvement Program that identifies the Regional Board’s expectations with respect to the content of SWPPPs, including documentation regarding the selection and implementation of BMPs, and a sampling and analysis plan. The Improvement Program shall include specific guidance regarding the development and implementation of monitoring plans, including the constituents to be monitored, sampling frequency and analytical protocols. The SWPPP Improvement Program shall be completed by *(the date of OAL approval of this BPA)*. **No later than two months** from completion of the Improvement Program, Board staff shall assure that the requirements of the Program are communicated to interested parties, including dischargers with existing authorizations under the General Construction Permit. Existing, authorized dischargers shall revise their project SWPPPs as needed to address the Program requirements as soon as possible but **no later than (three months of completion of the SWPPP Improvement Program)**. Applicable SWPPPs that do not adequately address the Program requirements shall be considered inadequate and enforcement by the Regional Board shall proceed accordingly. The Caltrans and Orange County MS4 permits shall be revised as needed to assure that the permittees communicate the Regional Board’s SWPPP expectations, based on the SWPPP Improvement Program, with the Standard Conditions of Approval.

Appendix 4 Sediment TMDLs

Implemented Sediment TMDLs in California. Construction was listed as a source in all fo these TMDLs in relation to road construction. Although construction was mentioned as a source, it was not given a specific allocation amount. The closest allocation amount would be for the road activity management WLA. **Implementation Phase** – Adoption process by the Regional Board, the State Water Resources Control Board, the Office of Administrative Law, and the US Environmental Protection Agency completed and TMDL being implemented.

A. Region	Type	Name	Pollutant Stressor	Potential Sources	TMDL Completion Date	Watershed Acres	WLA tons mi² yr
1 R1.epa.albionfinaltmdl	R	Albion River	Sedimentation	Road Construction	2001	43 acres	See A (table 6)

B Region	Type	Name	Pollutant Stressor	Potential Sources	TMDL Completion Date	Watershed Acres	WLA tons mi² yr
1 R1.epa.EelR-middle.mainSed.temp	R	Middle Main Eel River and Tributaries (from Dos Rios to the South Fork)	Sedimentation	Road Construction	2005-2006	521 mi ²	100

C Region	Type	Name	Pollutant Stressor	Potential Sources	TMDL Completion Date	Watershed Acres	WLA tons mi² yr
1 R1.epa.EelRsouth.sed.temp	R	South Fork Eel River	Sedimentation	Road Construction	12 1999	See chart	473

D Region	Type	Name	Pollutant Stressor	Potential Sources	TMDL Completion Date	Watershed Acres	WLA tons mi² yr
1 R1.epa.bigfinaltmdl	R	Big River	Sedimentation	Road Construction	12 2001	181 mi ² watershed drainage	TMDL = loading capacity = nonpoint sources + background =

							393 t mi ² yr
--	--	--	--	--	--	--	--------------------------

E Region	Type	Name	Pollutant Stressor	Potential Sources	TMDL Completion Date	Watershed Acres	WLA tons mi² yr
1 R1.epa.EelR-lower.Sed.temp-121807-signed	R	Lower Eel River	Sedimentation	Road Construction	12 2007	300 square-mile watershed	898

F Region	Type	Name	Pollutant Stressor	Potential Sources	TMDL Completion Date	Watershed Acres	WLA tons mi² yr
1 R1.epa.EelR-middle.Sed.temp-	R	Middle Fork Eel River	Sedimentation	Road Construction	12 2003	753 mi ² (approx. 482,000 acres)	82

G Region	Type	Name	Pollutant Stressor	Potential Sources	TMDL Completion Date	Watershed Acres Mi²	WLA tons mi² yr
1 R1.epa.EelRnorth-Sed.temp.final-121807-signed	R	North Fork Eel River	Sedimentation	Road Construction	12 30 2002	289 (180,020 acres)	20

H Region	Type	Name	Pollutant Stressor	Potential Sources	TMDL Completion Date	Watershed Acres Mi²	WLA tons mi² yr
1 R1.epa.EelR-upper.mainSed.temp-	R	Upper Main Eel River and Tributaries (including Tomki Creek, Outlet Creek and Lake Pillsbury)	Sedimentation	Road Construction	12 29 2004	688 (approx. 440,384 acres)	14

I Region	Type	Name	Pollutant Stressor	Potential Sources	TMDL Completion Date	Watershed Acres	WLA tons mi ² yr
1 R1.epa.gualalafina ltmdl	R	Gualala River	Sedimentation	Road Construction	Not sure	300 (191,145 acres)	7

J Region	Type	Name	Pollutant Stressor	Potential Sources	TMDL Completion Date	Watershed Acres mi ²	WLA tons mi ² yr
1 R1.epa.Mad- sed.turbidity	R	Mad River	Sedimentation	Road Construction	12 21 2007	480	174

K Region	Type	Name	Pollutant Stressor	Potential Sources	TMDL Completion Date	Watershed Acres mi ²	WLA tons mi ² yr
1 R1.epa.mattole.se diment	R	Mattole River	Sedimentation	Road Construction	12 30 2003	296	27 or 520+27 = 547

L Region	Type	Name	Pollutant Stressor	Potential Sources	TMDL Completion Date	Watershed Acres mi ²	WLA tons mi ² yr
1 R1.epa.navarro.se d.temp	R	Navarro River	Sedimentation	Road Construction	Not sure	315 (201,600 acres).	50

M Region	Type	Name	Pollutant Stressor	Potential Sources	TMDL Completion Date	Watershed Acres mi ²	WLA tons mi ² yr
1 R1.epa.noyo.sedi ment	R	Noyo River	Sedimentation	Road Construction	12 16 1999	113 (72,323 acres)	68 (three areas measured) Table 16 in the TMDL

N Region	Type	Name	Pollutant Stressor	Potential Sources	TMDL Completion Date	Watershed Acres mi²	WLA tons mi² yr
1 R1.epa.RedwoodCk.sed	Cr	Redwood Creek	Sedimentation	Road Construction	12 30 1998	278	1900 Total allocation

O Region	Type	Name	Pollutant Stressor	Potential Sources	TMDL Completion Date	Watershed Acres mi²	WLA – Roads tons mi² yr
1 R1.epa.tenmile.sed	R	Ten Mile River	Sedimentation	Road Construction	2000	120	9

P Region	Type	Name	Pollutant Stressor	Potential Sources	TMDL Completion Date	Watershed Acres mi²	WLA management tons mi² yr
1 R1.epa.trinity.sed	R	Trinity River	Sedimentation	Road Construction	12 20 2001	2000 of 3000 covered in this TMDL	See rows below
1	Cr	Horse Linto Creek	Sedimentation	Road Construction	12 20 2001	64	528
1	Cr	Mill creek and Tish Tang	Sedimentation	Road Construction	12 20 2001	39	210
1	Cr	Willow Creek	Sedimentation	Road Construction	12 20 2001	43	94
1	Cr	Campbell Creek and Supply Creek	Sedimentation	Road Construction	12 20 2001	11	1961
1	Cr	Lower Mainstem and Coon Creek	Sedimentation	Road Construction	12 20 2001	32	63
1	R	Reference	Sedimentation	Road	12 20 2001	434	24

		Subwatershed ¹		Construction			
1	Cr	Canyon Creek	Sedimentation	Road Construction	12 20 2001	64	326
1	R	Upper Tributaries ²	Sedimentation	Road Construction	12 20 2001	72	67
1	R	Middle Tributaries ³	Sedimentation	Road Construction	12 20 2001	54	53
1	R	Lower Tributaries ⁴	Sedimentation	Road Construction	12 20 2001	96	55
1	Cr	Weaver and Rush Creeks	Sedimentation	Road Construction	12 20 2001	72	169
1	Cr	Deadwood Creek Hoadley Gulch Poker Bar	Sedimentation	Road Construction	12 20 2001	47	68
1	L	Lewiston Lake	Sedimentation	Road Construction	12 20 2001	25	49
1	Cr	Grassvalley Creek	Sedimentation	Road Construction	12 20 2001	37	44
1	Cr	Indian Creek	Sedimentation	Road Construction	12 20 2001	34	81
1	Cr	Reading and Browns Creek	Sedimentation	Road Construction	12 20 2001	104	66
1	Cr	Reference Subwatersheds ⁵	Sedimentation	Road Construction	12 20 2001	235	281
1	L, Cr	Westside tributaries ⁶	Sedimentation	Road Construction	12 20 2001	93	105
1	R, Cr, G	Upper trinity ⁷	Sedimentation	Road Construction	12 20 2001	161	690
1	R, Cr, G	East Fork Tributaries ⁸	Sedimentation	Road Construction	12 20 2001	115	65

1
2
3
4
5
6
7
8

1	R, L	Eastside Tributaries ⁹	Sedimentation	Road Construction	12 20 2001	89	60
---	------	-----------------------------------	---------------	-------------------	------------	----	----

- 1 New River, Big French, Manzanita, North Fork, East Fork, North Fork
- 2 Dutch, Soldier, Oregon gulch, Conner Creek
- 3 Big Bar, Prairie Creek, Little French Creek
- 4 Swede, Italian, Canadian, Cedar Flat, Mill, McDonald, Hennessy, Quimby, Hawkins, Sharber
- 5 Stuarts Fork, Swift Creek, Coffee Creek
- 6 Stuart Arm, Stoney Creek, Mule Creek, East Fork, Stuart Fork, West Side Trinity Lake, Hatchet Creek, Buckeye Creek,
- 7 Upper Trinity River, Tangle Blue, Sunflower, Graves, Bear Upper Trinity Mainstream, Ramshorn Creek, Ripple Creek, Minnehaha Creek, Snowslide Gulch, Scorpion Creek
- 8 East Fork Trinity, Cedar Creek, Squirrel Gulch
- 9 East Side Tributaries, Trinity Lake

Q Region	Type	Name	Pollutant Stressor	Potential Sources	TMDL Completion Date	Watershed Acres mi ²	WLA tons mi ² yr
1 R1.epa.trinity.so.sed	R, Cr	South Fork Trinity River and Hayfork Creek	Sedimentation	Road Construction	12 1998	Not given, 19 miles long	33 (road total)

R Region	Type	Name	Pollutant Stressor	Potential Sources	TMDL Completion Date	Watershed Acres mi ²	WLA tons mi ² yr
1 R1.epa.vanduzen.sed	R, Cr	Van Duzen River and Yager Creek	Sedimentation	Various	12 16 1999	429	1353 total allocation
1		Upper Basin	Sedimentation	Road Construction			7
1		Middle Basin	Sedimentation	Road Construction			22
1		Lower Basin	Sedimentation	Road Construction			20

S Region	Type	Name	Pollutant Stressor	Potential	TMDL	Watershed	WLA tons mi ²
----------	------	------	--------------------	-----------	------	-----------	--------------------------

⁹

				Sources	Completion Date	Acres mi²	yr
6	R6.blackwood.sed	Cr	Blackwood Creek (Placer County)	Bedded Sediment	Various	9 2007	11 17272 total

T Region	Type	Name	Pollutant Stressor	Potential Sources	TMDL Completion Date	Watershed Acres mi²	WLA tons mi² yr
6	R6.SquawCk.sed	R	Squaw Creek (Placer County)	Sedimentation /controllable sources	Various – basin plan amendment	4 13 2006	8.2 10,900

Adopted TMDLs for Construction Sediment Sources

Region	Type	Name	Pollutant Stressor	Potential Sources	TMDL Completion Date	Watershed Area mi²	Waste load Allocation tons mi² yr
8	R	Newport Bay San Diego Creek Watershed	Sedimentation	Construction Land Development	1999	2.24 (1432 acres)	125,000 tons per Year (no more than 13,000 tons per year from construction sites)

APPENDIX 5: Glossary

Active Areas of Construction

All areas subject to land surface disturbance activities related to the project including, but not limited to, project staging areas, immediate access areas and storage areas. All previously active areas are still considered active areas until final stabilization is complete. [The construction activity Phases used in this General Permit are the Preliminary Phase, Grading and Land Development Phase, Streets and Utilities Phase, and the Vertical Construction Phase.]

Active Treatment System (ATS)

A treatment system that employs chemical coagulation, chemical flocculation, or electrocoagulation to aid in the reduction of turbidity caused by fine suspended sediment.

Acute Toxicity Test

A chemical stimulus severe enough to rapidly induce a negative effect; in aquatic toxicity tests, an effect observed within 96 hours or less is considered acute.

Air Deposition

Airborne particulates from construction activities.

Approved Signatory

A person who has been authorized by the Legally Responsible Person to sign, certify, and electronically submit Permit Registration Documents, Notices of Termination, and any other documents, reports, or information required by the General Permit, the State or Regional Water Board, or U.S. EPA. The Approved Signatory must be one of the following:

1. For a corporation or limited liability company: a responsible corporate officer. For the purpose of this section, a responsible corporate officer means: (a) a president, secretary, treasurer, or vice-president of the corporation in charge of a principal business function, or any other person who performs similar policy or decision-making functions for the corporation or limited liability company; or (b) the manager of the facility if authority to sign documents has been assigned or delegated to the manager in accordance with corporate procedures;
2. For a partnership or sole proprietorship: a general partner or the proprietor, respectively;
3. For a municipality, State, Federal, or other public agency: a principal executive officer, ranking elected official, city manager, council president, or any other authorized public employee with managerial responsibility over the

construction or land disturbance project (including, but not limited to, project manager, project superintendent, or resident engineer);

4. For the military: any military officer or Department of Defense civilian, acting in an equivalent capacity to a military officer, who has been designated;
5. For a public university: an authorized university official;
6. For an individual: the individual, because the individual acts as both the Legally Responsible Person and the Approved Signatory; or
7. For any type of entity not listed above (e.g. trusts, estates, receivers): an authorized person with managerial authority over the construction or land disturbance project.

Beneficial Uses

As defined in the California Water Code, beneficial uses of the waters of the state that may be protected against quality degradation include, but are not limited to, domestic, municipal, agricultural and industrial supply; power generation; recreation; aesthetic enjoyment; navigation; and preservation and enhancement of fish, wildlife, and other aquatic resources or preserves.

Best Available Technology Economically Achievable (BAT)

As defined by USEPA, BAT is a technology-based standard established by the Clean Water Act (CWA) as the most appropriate means available on a national basis for controlling the direct discharge of toxic and nonconventional pollutants to navigable waters. The BAT effluent limitations guidelines, in general, represent the best existing performance of treatment technologies that are economically achievable within an industrial point source category or subcategory.

Best Conventional Pollutant Control Technology (BCT)

As defined by USEPA, BCT is a technology-based standard for the discharge from existing industrial point sources of conventional pollutants including biochemical oxygen demand (BOD), total suspended sediment (TSS), fecal coliform, pH, oil and grease.

Best Professional Judgment (BPJ)

The method used by permit writers to develop technology-based NPDES permit conditions on a case-by-case basis using all reasonably available and relevant data.

Best Management Practices (BMPs)

BMPs are scheduling of activities, prohibitions of practices, maintenance procedures, and other management practices to prevent or reduce the discharge of pollutants. BMPs also include treatment requirements, operating procedures,

and practices to control site runoff, spillage or leaks, sludge or waste disposal, or drainage from raw material storage.

Chain of Custody (COC)

Form used to track sample handling as samples progress from sample collection to the analytical laboratory. The COC is then used to track the resulting analytical data from the laboratory to the client. COC forms can be obtained from an analytical laboratory upon request.

Coagulation

The clumping of particles in a discharge to settle out impurities, often induced by chemicals such as lime, alum, and iron salts.

Common Plan of Development

Generally a contiguous area where multiple, distinct construction activities may be taking place at different times under one plan. A plan is generally defined as any piece of documentation or physical demarcation that indicates that construction activities may occur on a common plot. Such documentation could consist of a tract map, parcel map, demolition plans, grading plans or contract documents. Any of these documents could delineate the boundaries of a common plan area. However, broad planning documents, such as land use master plans, conceptual master plans, or broad-based CEQA or NEPA documents that identify potential projects for an agency or facility are not considered common plans of development.

Daily Average Discharge

The discharge of a pollutant measured during any 24-hour period that reasonably represents a calendar day for purposes of sampling. For pollutants with limitations expressed in units of mass, the daily discharge is calculated as the total mass of the pollutant discharged during the day. For pollutants with limitations expressed in other units of measurement (e.g., concentration) the daily discharge is calculated as the average measurement of the pollutant throughout the day (40 CFR 122.2). In the case of pH, the pH must first be converted from a log scale.

Debris

Litter, rubble, discarded refuse, and remains of destroyed inorganic anthropogenic waste.

Direct Discharge

A discharge that is routed directly to waters of the United States by means of a pipe, channel, or ditch (including a municipal storm sewer system), or through surface runoff.

Discharger

The Legally Responsible Person (see definition) or entity subject to this General Permit.

Dose Rate (for ATS)

In exposure assessment, dose (e.g. of a chemical) per time unit (e.g. mg/day), sometimes also called dosage.

Drainage Area

The area of land that drains water, sediment, pollutants, and dissolved materials to a common outlet.

Effluent

Any discharge of water by a discharger either to the receiving water or beyond the property boundary controlled by the discharger.

Effluent Limitation

Any numeric or narrative restriction imposed on quantities, discharge rates, and concentrations of pollutants which are discharged from point sources into waters of the United States, the waters of the contiguous zone, or the ocean.

Erosion

The process, by which soil particles are detached and transported by the actions of wind, water, or gravity.

Erosion Control BMPs

Vegetation, such as grasses and wildflowers, and other materials, such as straw, fiber, stabilizing emulsion, protective blankets, etc., placed to stabilize areas of disturbed soils, reduce loss of soil due to the action of water or wind, and prevent water pollution.

Field Measurements

Testing procedures performed in the field with portable field-testing kits or meters.

Final Stabilization

All soil disturbing activities at each individual parcel within the site have been completed in a manner consistent with the requirements in this General Permit.

First Order Stream

Stream with no tributaries.

Flocculants

Substances that interact with suspended particles and bind them together to form flocs.

Good Housekeeping BMPs

BMPs designed to reduce or eliminate the addition of pollutants to construction site runoff through analysis of pollutant sources, implementation of proper handling/disposal practices, employee education, and other actions.

Grading Phase (part of the Grading and Land Development Phase)

Includes reconfiguring the topography and slope including; alluvium removals; canyon cleanouts; rock undercuts; keyway excavations; land form grading; and stockpiling of select material for capping operations.

Hydromodification

Hydromodification is the alteration of the hydrologic characteristics of coastal and non-coastal waters, which in turn could cause degradation of water resources. Hydromodification can cause excessive erosion and/or sedimentation rates, causing excessive turbidity, channel aggradation and/or degradation.

Identified Organisms

Organisms within a sub-sample that is specifically identified and counted.

Inactive Areas of Construction

Areas of construction activity that are not active and those that have been active and are not scheduled to be re-disturbed for at least 14 days.

Index Period

The period of time during which bioassessment samples must be collected to produce results suitable for assessing the biological integrity of streams and rivers. Instream communities naturally vary over the course of a year, and sampling during the index period ensures that samples are collected during a time frame when communities are stable so that year-to-year consistency is obtained. The index period approach provides a cost-effective alternative to year-round sampling. Furthermore, sampling within the appropriate index period will yield results that are comparable to the assessment thresholds or criteria for a given region, which are established for the same index period. Because index periods differ for different parts of the state, it is essential to know the index period for your area.

K Factor

The soil erodibility factor used in the Revised Universal Soil Loss Equation (RUSLE). It represents the combination of detachability of the soil, runoff potential of the soil, and the transportability of the sediment eroded from the soil.

Legally Responsible Person

The Legally Responsible Person (LRP) will typically be the project proponent. The categories of persons or entities that are eligible to serve as the LRP are set forth below. For any construction or land disturbance project where multiple persons or entities are eligible to serve as the LRP, those persons or entities

shall select a single LRP. In exceptional circumstances, a person or entity that qualifies as the LRP may provide written authorization to another person or entity to serve as the LRP. In such a circumstance, the person or entity that provides the authorization retains all responsibility for compliance with the General Permit. Except as provided in category 2(d), a contractor who does not satisfy the requirements of any of the categories below is not qualified to be an LRP.

The following persons or entities may serve as an LRP:

1. A person, company, agency, or other entity that possesses a real property interest (including, but not limited to, fee simple ownership, easement, leasehold, or other rights of way) in the land upon which the construction or land disturbance activities will occur for the regulated site.
2. In addition to the above, the following persons or entities may also serve as an LRP:
 - a. For linear underground/overhead projects, the utility company, municipality, or other public or private company or agency that owns or operates the LUP;
 - b. For land controlled by an estate or similar entity, the person who has day-to-day control over the land (including, but not limited to, a bankruptcy trustee, receiver, or conservator);
 - c. For pollution investigation and remediation projects, any potentially responsible party that has received permission to conduct the project from the holder of a real property interest in the land; or
 - d. For U.S. Army Corp of Engineers projects, the U.S. Army Corps of Engineers may provide written authorization to its bonded contractor to serve as the LRP, provided, however, that the U.S. Army Corps of Engineers is also responsible for compliance with the general permit, as authorized by the Clean Water Act or the Federal Facilities Compliance Act.

Likely Precipitation Event

Any weather pattern that is forecasted to have a 50% or greater chance of producing precipitation in the project area. The discharger shall obtain likely precipitation forecast information from the National Weather Service Forecast Office (e.g., by entering the zip code of the project's location at <http://www.srh.noaa.gov/forecast>).

Maximum Allowable Threshold Concentration (MATC)

The allowable concentration of residual, or dissolved, coagulant/flocculant in effluent. The MATC shall be coagulant/flocculant-specific, and based on toxicity

testing conducted by an independent, third-party laboratory. A typical MATC would be:

The MATC is equal to the geometric mean of the NOEC (No Observed Effect Concentration) and LOEC (Lowest Observed Effect Concentration) Acute and Chronic toxicity results for most sensitive species determined for the specific coagulant. The most sensitive species test shall be used to determine the MATC.

Natural Channel Evolution

The physical trend in channel adjustments following a disturbance that causes the river to have more energy and degrade or aggrade more sediment. Channels have been observed to pass through 5 to 9 evolution types. Once they pass through the suite of evolution stages, they will rest in a new state of equilibrium.

Non-Storm Water Discharges

Discharges are discharges that do not originate from precipitation events. They can include, but are not limited to, discharges of process water, air conditioner condensate, non-contact cooling water, vehicle wash water, sanitary wastes, concrete washout water, paint wash water, irrigation water, or pipe testing water.

Non-Visible Pollutants

Pollutants associated with a specific site or activity that can have a negative impact on water quality, but cannot be seen through observation (ex: chlorine). Such pollutants being discharged are not authorized.

Numeric Action Level (NAL)

Level is used as a warning to evaluate if best management practices are effective and take necessary corrective actions. Not an effluent limit.

Original Sample Material

The material (i.e., macroinvertebrates, organic material, gravel, etc.) remaining after the subsample has been removed for identification.

pH

Unit universally used to express the intensity of the acid or alkaline condition of a water sample. The pH of natural waters tends to range between 6 and 9, with neutral being 7. Extremes of pH can have deleterious effects on aquatic systems.

Post-Construction BMPs

Structural and non-structural controls which detain, retain, or filter the release of pollutants to receiving waters after final stabilization is attained.

Preliminary Phase (Pre-Construction Phase - Part of the Grading and Land Development Phase)

Construction stage including rough grading and/or disking, clearing and grubbing operations, or any soil disturbance prior to mass grading.

Project

Qualified SWPPP Developer

Individual who is authorized to develop and revise SWPPPs.

Qualified SWPPP Practitioner

Individual assigned responsibility for non-storm water and storm water visual observations, sampling and analysis, and responsibility to ensure full compliance with the permit and implementation of all elements of the SWPPP, including the preparation of the annual compliance evaluation and the elimination of all unauthorized discharges.

Qualifying Rain Event

Any event that produces 0.5 inches or more precipitation with a 48 hour or greater period between rain events.

R Factor

Erosivity factor used in the Revised Universal Soil Loss Equation (RUSLE). The R factor represents the erosivity of the climate at a particular location. An average annual value of R is determined from historical weather records using erosivity values determined for individual storms. The erosivity of an individual storm is computed as the product of the storm's total energy, which is closely related to storm amount, and the storm's maximum 30-minute intensity.

Rain Event Action Plan (REAP)

Written document, specific for each rain event, that when implemented is designed to protect all exposed portions of the site within 48 hours of any likely precipitation event.

Remaining Sub sampled Material

The material (e.g., organic material, gravel, etc.) that remains after the organisms to be identified have been removed from the subsample for identification. (Generally, no macroinvertebrates are present in the remaining subsampled material, but the sample needs to be checked and verified using a complete Quality Assurance (QA) plan)

Routine Maintenance

Activities intended to maintain the original line and grade, hydraulic capacity, or original purpose of a facility.

Runoff Control BMPs

Measures used to divert runoff from offsite and runoff within the site.

Run-on

Discharges that originate offsite and flow onto the property of a separate project site.

Revised Universal Soil Loss Equation (RUSLE)

Empirical model that calculates average annual soil loss as a function of rainfall and runoff erosivity, soil erodibility, topography, erosion controls, and sediment controls.

Sampling and Analysis Plan

Document that describes how the samples will be collected, under what conditions, where and when the samples will be collected, what the sample will be tested for, what test methods and detection limits will be used, and what methods/procedures will be maintained to ensure the integrity of the sample during collection, storage, shipping and testing (i.e., quality assurance/quality control protocols).

Sediment

Solid particulate matter, both mineral and organic, that is in suspension, is being transported, or has been moved from its site of origin by air, water, gravity, or ice and has come to rest on the earth's surface either above or below sea level.

Sedimentation

Process of deposition of suspended matter carried by water, wastewater, or other liquids, by gravity. It is usually accomplished by reducing the velocity of the liquid below the point at which it can transport the suspended material.

Sediment Control BMPs

Practices that trap soil particles after they have been eroded by rain, flowing water, or wind. They include those practices that intercept and slow or detain the flow of storm water to allow sediment to settle and be trapped (e.g., silt fence, sediment basin, fiber rolls, etc.).

Settleable Solids (SS)

Solid material that can be settled within a water column during a specified time frame. It is typically tested by placing a water sample into an Imhoff settling cone and then allowing the solids to settle by gravity for a given length of time. Results are reported either as a volume (mL/L) or a mass (mg/L) concentration.

Sheet Flow

Flow of water that occurs overland in areas where there are no defined channels where the water spreads out over a large area at a uniform depth.

Site**Soil Amendment**

Any material that is added to the soil to change its chemical properties, engineering properties, or erosion resistance that could become mobilized by storm water.

Streets and Utilities Phase

Construction stage including excavation and street paving, lot grading, curbs, gutters and sidewalks, public utilities, public water facilities including fire hydrants, public sanitary sewer systems, storm sewer system and/or other drainage improvements.

Structural Controls

Any structural facility designed and constructed to mitigate the adverse impacts of storm water and urban runoff pollution

Suspended Sediment Concentration (SSC)

The measure of the concentration of suspended solid material in a water sample by measuring the dry weight of all of the solid material from a known volume of a collected water sample. Results are reported in mg/L.

Total Suspended Solids (TSS)

The measure of the suspended solids in a water sample includes inorganic substances, such as soil particles and organic substances, such as algae, aquatic plant/animal waste, particles related to industrial/sewage waste, etc. The TSS test measures the concentration of suspended solids in water by measuring the dry weight of a solid material contained in a known volume of a sub-sample of a collected water sample. Results are reported in mg/L.

Toxicity

The adverse response(s) of organisms to chemicals or physical agents ranging from mortality to physiological responses such as impaired reproduction or growth anomalies.

Turbidity

The cloudiness of water quantified by the degree to which light traveling through a water column is scattered by the suspended organic and inorganic particles it contains. The turbidity test is reported in Nephelometric Turbidity Units (NTU) or Jackson Turbidity Units (JTU).

Vertical Construction Phase

The Build out of structures from foundations to roofing, including rough landscaping.

Waters of the United States

Generally refers to surface waters, as defined by the federal Environmental Protection Agency in 40 C.F.R. § 122.2.¹

Water Quality Objectives (WQO)

Water quality objectives are defined in the California Water Code as limits or levels of water quality constituents or characteristics, which are established for the reasonable protection of beneficial uses of water or the prevention of nuisance within a specific area.

¹ The application of the definition of “waters of the United States” may be difficult to determine; there are currently several judicial decisions that create some confusion. If a landowner is unsure whether the discharge must be covered by this General Permit, the landowner may wish to seek legal advice.

APPENDIX 6: Acronym List

ASBS	Areas of Special Biological Significance
ASTM	American Society of Testing and Materials; Standard Test Method for Particle-Size Analysis of Soils
ATS	Active Treatment System
BASMAA	Bay Area Storm water Management Agencies Association
BAT	Best Available Technology Economically Achievable
BCT	Best Conventional Pollutant Control Technology
BMP	Best Management Practices
BOD	Biochemical Oxygen Demand
BPJ	Best Professional Judgment
CAFO	Confined Animal Feeding Operation
CCR	California Code of Regulations
CEQA	California Environmental Quality Act
CFR	Code of Federal Regulations
CGP	NPDES General Permit for Storm Water Discharges Associated with Construction Activities
CIWQS	California Integrated Water Quality System
CKD	Cement Kiln Dust
COC	Chain of Custody
CPESC	Certified Professional in Erosion and Sediment Control
CPSWQ	Certified Professional in Storm Water Quality
CSMP	Construction Site Monitoring Program
CTB	Cement Treated Base
CTR	California Toxics Rule
CWA	Clean Water Act
CWC	California Water Code
CWP	Center for Watershed Protection
DADMAC	Diallyldimethyl-ammonium chloride
DDNR	Delaware Department of Natural Resources
DFG	Department of Fish and Game
DHS	Department of Health Services
DWQ	Division of Water Quality
EC	Electrical Conductivity
ELAP	Environmental Laboratory Accreditation Program
EPA	Environmental Protection Agency
ESA	Environmentally Sensitive Area
ESC	Erosion and Sediment Control
HSPF	Hydrologic Simulation Program Fortran
JTU	Jackson Turbidity Units
LID	Low Impact Development
LOEC	Lowest Observed Effect Concentration
LRP	Legally Responsible Person
LUP	Linear Underground/Overhead Projects

MATC	Maximum Allowable Threshold Concentration
MDL	Method Detection Limits
MRR	Monitoring and Reporting Requirements
MS4	Municipal Separate Storm Sewer System
MUSLE	Modified Universal Soil Loss Equation
NAL	Numeric Action Level
NEL	Numeric Effluent Limitation
NICET	National Institute for Certification in Engineering Technologies
NOAA	National Oceanic and Atmospheric Administration
NOEC	No Observed Effect Concentration
NOI	Notice of Intent
NOT	Notice of Termination
NPDES	National Pollutant Discharge Elimination System
NRCS	Natural Resources Conservation Service
NTR	National Toxics Rule
NTU	Nephelometric Turbidity Units
O&M	Operation and Maintenance
PAC	Polyaluminum chloride
PAM	Polyacrylamide
PASS	Polyaluminum chloride Silica/sulfate
POC	Pollutants of Concern
PoP	Probability of Precipitation
POTW	Publicly Owned Treatment Works
PRDs	Permit Registration Documents
PWS	Planning Watershed
QAMP	Quality Assurance Management Plan
QA/QC	Quality Assurance/Quality Control
REAP	Rain Event Action Plan
Regional Board	Regional Water Quality Control Board
ROWD	Report of Waste Discharge
RUSLE	Revised Universal Soil Loss Equation
RW	Receiving Water
SMARTS System	Storm water Multi Application Reporting and Tracking System
SS	Settleable Solids
SSC	Suspended Sediment Concentration
SUSMP	Standard Urban Storm Water Mitigation Plan
SW	Storm Water
SWARM	Storm Water Annual Report Module
SWAMP	Surface Water Ambient Monitoring Program
SWMM	Storm Water Management Model
SWMP	Storm Water Management Program
SWPPP	Storm Water Pollution Prevention Plan
TC	Treatment Control
TDS	Total Dissolved Solids

TMDL	Total Maximum Daily Load
TSS	Total Suspended Solids
USACOE	U.S. Army Corps of Engineers
USC	United States Code
USEPA	United States Environmental Protection Agency
USGS	United States Geological Survey
WDID	Waste Discharge Identification Number
WDR	Waste Discharge Requirements
WLA	Waste Load Allocation
WET	Whole Effluent Toxicity
WRCC	Western Regional Climate Center
WQBEL	Water Quality Based Effluent Limitation
WQO	Water Quality Objective
WQS	Water Quality Standard

APPENDIX 7: State and Regional Water Resources Control Board Contacts

NORTH COAST REGION (1)
5550 Skylane Blvd, Ste. A
Santa Rose, CA 95403
(707) 576-2220 FAX: (707)523-0135

SAN FRANCISCO BAY REGION (2)
1515 Clay Street, Ste. 1400
Oakland, CA 94612
(510) 622-2300 FAX: (510) 622-2640

CENTRAL COAST REGION (3)
895 Aerovista Place, Ste 101
San Luis Obispo, CA 93401
(805) 549-3147 FAX: (805) 543-0397

LOS ANGELES REGION (4)
320 W. 4th Street, Ste. 200
Los Angeles, CA 90013
(213) 576-6600 FAX: (213) 576-6640

LAHONTAN REGION (6 SLT)
2501 Lake Tahoe Blvd.
South Lake Tahoe, CA 96150
(530) 542-5400 FAX: (530) 544-2271

VICTORVILLE OFFICE (6V)
14440 Civic Drive, Ste. 200
Victorville, CA 92392-2383
(760) 241-6583 FAX: (760) 241-7308

CENTRAL VALLEY REGION (5S)
11020 Sun Center Dr., #200
Rancho Cordova, CA 95670-6114
(916) 464-3291 FAX: (916) 464-4645

FRESNO BRANCH OFFICE (5F)
1685 E St.
Fresno, CA 93706
(559) 445-5116 FAX: (559) 445-5910

REDDING BRANCH OFFICE (5R)
364 Knollcrest Drive, Ste. 205
Redding, CA 96002
(530) 224-4845 FAX: (530) 224-4857

COLORADO RIVER BASIN REGION (7)
73-720 Fred Waring Dr., Ste. 100
Palm Desert, CA 92260
(760) 346-7491 FAX: (760) 341-6820

SANTA ANA REGION (8)
3737 Main Street, Ste. 500
Riverside, CA 92501-3339
Phone (951) 782-4130 FAX: (951) 781-6288

SAN DIEGO REGION (9)
9174 Sky Park Court, Ste. 100
San Diego, CA 92123-4340
(858) 467-2952 FAX: (858) 571-6972

STATE WATER BOARD
PO Box 1977
Sacramento, CA 95812-1977
stormwater@waterboards.ca.gov

